

KENYA INDUSTRIAL PROPERTY INSTITUTE



## INDUSTRIAL PROPERTY JOURNAL

(Journal of Patents, Industrial Designs, Utility Models and Trade marks)

No. 2026/03

31<sup>st</sup> March, 2026

Published Monthly

**EDITORIAL**

The Industrial Property Journal is the Official Journal of the Kenya Industrial Property Institute. Publication of the Journal is provided for under the Industrial Property Act, 2001 and regulation 7 of the Industrial Property Regulations 2002. The Journal is published monthly by the Institute as part of the procedures for protection of industrial property rights under the Industrial Property Act, No. 3 of 2001 and the Trade Marks Act, Cap 506 of the Laws of Kenya.

.....

**PUBLICATION FEES FOR MARKS**

	Foreign	Local
For the first class.....	US\$ 60	Ksh. 3, 000/=
For each subsequent class.....	US\$ 50	Ksh. 2, 500/=

The above-mentioned charges apply for all other matters required to be published under the Trade Marks Act, Cap 506 of the Laws of Kenya

.....

**PUBLICATION FEES FOR PATENTS, UTILITY MODELS AND INDUSTRIAL DESIGNS**

Foreign	Local
US\$ 150	Ksh. 3, 000/=

The above-mentioned charges apply for all other matters required to be published under the Industrial Property Act, No. 3 of 2001

.....

Published and edited by:  
Kenya Industrial Property Institute  
P.O. Box 51648-00200 Nairobi.  
Tel: 254-02-6002210/11, 6006326/29/36  
Mobile No: 0736002020  
Wireless: 0202386220  
Fax: 254-02-6006312  
Email: [info@kipi.go.ke](mailto:info@kipi.go.ke) Website:  
[www.kipi.go.ke](http://www.kipi.go.ke)

© Kenya Industrial Property Institute 2026

# The Industrial Property Journal

## Contents

EDITORIAL .....	1
PUBLICATION FEES FOR PATENTS, UTILITY MODELS AND INDUSTRIAL DESIGNS .....	1
WIPO standards INID CODES .....	3
GENERAL NOTICES.....	4
<b>1.0 PATENT APPLICATIONS PUBLISHED UNDER SECTION 42 AND REGULATION 35. ....</b>	<b>5</b>
1.1 National Application .....	5
<b>2.0 Patents Granted under Section 45 .....</b>	<b>8</b>
2.1 National Patents .....	8
2.2 ARIPO GRANTED PATENTS .....	9
<b>3.0 PATENTS RENEWED UNDER SECTION 61 .....</b>	<b>19</b>
3.1 National Patents .....	19
3.2 NA Change of Owner to Advt .....	22
3.3 NA Change of Owner .....	22
<b>4.0 UTILITY MODEL APPLICATIONS PUBLISHED UNDER SECTION 42 AND REGULATION 35 .....</b>	<b>22</b>
4.1 National Application .....	22
4.2 Utility Model Granted.....	25
<b>5.0 UTILITY MODELS REGISTERED .....</b>	<b>25</b>
5.1 National Utility Models .....	25
5.2 ARIPO UTILITY MODEL REGISTERED .....	25
<b>6.0 UTILITY MODELS RENEWED.....</b>	<b>25</b>
6.1 Utility Model Issue Certificate .....	25
<b>7.0 INDUSTRIAL DESIGN APPLICATIONS PUBLISHED UNDER SECTION 87 AND REGULATION 48 .....</b>	<b>27</b>
7.1 National Applications .....	27
7.2 Corrigenda .....	29
<b>7.3 Registered Industrial Designs .....</b>	<b>30</b>
7.4 Industrial Designs Renewed.....	34
<b>8.0 ARIPO APPLICATIONS.....</b>	<b>35</b>
8.1 ARIPO Industrial Designs Registered .....	35
<b>9.0 Trade Marks.....</b>	<b>37</b>
9.1 Applications accepted for registration .....	37
9.2 Corrigenda.....	142
9.3 Licence .....	143
9.4 Withdrawal .....	144
9.5 Abandonment .....	144
9.6 Alteration of Goods .....	144
9.7 Alteration.....	145
9.8 Removal .....	147
9.9 Surrender .....	148
<b>10.0 MADRID APPLICATIONS ACCEPTED FOR REGISTRATION .....</b>	<b>148</b>
<b>11.0 GENERAL INFORMATION.....</b>	<b>166</b>
1. Patent, Utility Models and Industrial Design fees. ....	166
2. African Regional Intellectual Property Organization (ARIPO) .....	166
3. Patent Cooperation Treaty .....	167
4. Kenya is a signatory to the following Treaties related to industrial property rights: .....	167
5. Trade Marks Forms and Fees .....	168
6. The International Classification of Goods and Services for the Purposes of the Registration of Marks (Nice Classification) .....	169
Nice Classification (13th Edition) C L A S S H E A D I N G S.....	169

INID is an acronym for 'Internationally agreed Numbers for the Identification of (bibliographic) Data'. The codes are used on the first page of industrial property documents and in gazettes to identify the bibliographic data without knowledge of the language used and the industrial property laws applied. The following INID codes are used in this Journal:

Standard ST.9 and ST.80 for Patents and utility Models and Industrial Designs

- (11) Number of the document
  - (12) Designation of the kind of document
  - (15) Correction information
  - (19) WIPO standard ST.3 code of the office or organization publishing the document
  - (21) Application Number
  - (22) Date of filing of application
  - (30) Priority data
  - (31) Priority Number(s).
  - (32) Priority Date(s).
  - (33) Priority Country(s).
  - (41) Publication date of unexamined application
  - (42) Publication date of examined application
  - (45) Publication date of registered right/Date of registration
  - (51) International classification.
  - (54) Title of the Invention.
  - (56) Cited documents
  - (57) Abstract
  - (71) Name(s) of applicant(s)
  - (72) Name(s) of Inventor(s)
  - (730) Proprietor
  - (740) Name and address of Agent or address for service
  - (85) Date of entry into national phase for PCT applications
  - (87) PCT Publication data Standard  
ST. 60 for Marks
  - 111 Registration number
  - 180 Expiry Date
  - 210 Application number
  - 220 Filing date of application
  - 300 Data relating to Application under the Paris convention
  - 442 Date of advertisement
  - 511 International classification and/or list of goods and services
  - 526 Disclaimer
  - 540 Reproduction of the Mark
  - 566 Translation of the mark or words contained in the mark
  - 15 Amendment/Correction information
  - 591 Information concerning colours claimed
  - 730 Name and address of the/proprietor
  - 740 Name and address of the agent or applicant
  - 791 Name and address of Licensee/registered user
-

## GENERAL NOTICES

24<sup>th</sup> November, 2025**Public Notice****Launch of the Patent Online Filing System**

The Institute is pleased to announce a significant milestone in our commitment to enhancing service delivery and embracing digital transformation. This is in line with the Government's digitalization of public services aimed at improving efficiency, accessibility and inclusivity as spelt out under the Bottom-Up Economic Transformation Agenda (BETA)'s 5<sup>th</sup> core pillar, the Digital Superhighway and Creative Economy.

We have officially launched our new Online Filing System, a secure and user-friendly platform designed to streamline the application process for industrial property (IP) rights.

With this new system, clients can now file and make payments for the following **National Applications** entirely online, from anywhere and at any time: -

- i. Patents
- ii. Industrial Designs; and
- iii. Utility Models

The e-Filing System is expected to bring benefits including 24/7 convenience whereby clients can file their applications outside of the traditional office working hours, ensure faster processing and enhance cost-effectiveness thereby saving on traveling, printing, and physical document handling costs.

The e-filing portal is live and accessible via the KIPi website under e-services menu at (<https://patentonline.kipi.go.ke/efiling/>). Additional information on how to use the e-filing system is available on the Institute's website [www.kipi.go.ke](http://www.kipi.go.ke).

All clients are encouraged to use this platform. For any assistance, contact us on Tel: 0702002020 and 0736002020 or email [ict@kipi.go.ke](mailto:ict@kipi.go.ke).

The Institute remains dedicated to fostering innovation and protection of IP in Kenya. The launch of this e-filing system is a testament to our ongoing efforts to modernize our services and better serve you.

We look forward to providing you with a more efficient and modern filing experience.

John Onyango  
Managing Director  
Kenya Industrial Property Institute

## 1.0 PATENT APPLICATIONS PUBLISHED UNDER SECTION 42 AND REGULATION 35.

### 1.1 National Application

(21) Application no.: KE/P/2023/4675

(22) Filing Date: 29/08/2023 (30) Priority:

(51) Int.Cl.2018.01 G 06Q 10/00(2012.01)

(54) Title: WORKLOAD MANAGER (WORKMAN)- AN APPLICATION TO MANAGE ORGANIZATIONS' WORKLOAD, EQUIPMENT AND RESOURCES

(72) Inventors: KIONI P. NDIRANGU and WANDETO JOHN MWANGI (73) Applicant(s): WANDETO JOHN MWANGIKIONI P. NDIRANGU PRIVATE BAG, 10143, DEDAN KIMATHI, Kenya and PRIVATE BAG, 10143, DEDAN KIMATHI, Kenya

(74) Agent: DEDAN KIMATHI UNIVERSITY OF TECHNOLOGY,

(57) To attain optimal performance within an organization, managers must utilize the available workforce and resources through tasks assignment. In a university setting, for example, lecturers have to be assigned units to teach and laboratories for students to carry out experiments. The objectives to be achieved within the academic year form the basis of the allocation of the resources to be used in teaching, research, and the administration of the university. The managers will then like to monitor the delivery and attendance of the set lessons. On the other hand, the lecturers and the support staff, such as laboratory technicians, may be interested in knowing their performance in order to make decisions that can assist in future improvement. Workman application enables duty allocations, monitoring and evaluation. PRIVATE BAG, 10143, DEDAN KIMATHI

.....  
(21) Application no.: KE/P/2025/5438

(22) Filing Date: 28/07/2025 (30) Priority:

(51) Int.Cl.2018.01 G 06F 7/00(2006.01), G 06T 17/00(2006.01)

(54) Title: SYSTEM AND METHOD FOR CONVERTING GEOSPATIAL KMZ DATA INTO SIMULATION-READY MODELS FOR ELECTRICAL DISTRIBUTION NETWORK ANALYSIS.

(72) Inventors: Christopher Maina Muriithi

(73) Applicant(s): MURANG'A UNIVERSITY OF TECHNOLOGY Christopher Maina Muriithi P. O. BOX 75-10200 MURANG'A, Kenya and P. O. BOX 75-10200 MURANG'A, Kenya

(74) Agent: MURANG'A UNIVERSITY OF TECHNOLOGY, P. O. BOX 75-10200 MURANG'A

(57) System and Method for Converting Geospatial Zipped Keyhole Markup Language (KMZ) Data into Simulation-Ready mathematical model in a high-level numerical computing environment for power system simulation of an Electrical Distribution Network. A system and method for converting Zipped Keyhole Markup Language (KMZ) data to a simulation-ready model of an electrical distribution network. The system parses Zipped Keyhole Markup Language (KMZ) geospatial data, classifies network components using metadata-driven rules, and algorithmically heals topological gaps to produce a digital model. The system generates mathematical models for power flow analysis from existing GIS data for network planning and diagnostics.

.....  
(21) Application no.: KE/P/2025/5440

(22) Filing Date: 30/07/2025 (30) Priority:

(51) Int.Cl. C 01D 7/00(2006.01)

(54) Title: A PROCESS FOR RECOVERING SODIUM CARBONATE FROM TRONA VIA SOLAR PONDS

(72) Inventors:

(73) Applicant(s): TATA CHEMICALS LIMITED TATA CHEMICALS MAGADI LIMITED Bombay House, 24 Homi Modi Street, 400 001 Mumbai, India and P.O BOX 1- 00205 MAGADI KENYA, Kenya

(74) Agent: PERPETUA N LAW ADVOCATES,

(57) A process for recovering sodium carbonate from trona is disclosed. The process comprises preparing a trona solution from trona at a temperature in a range from 25 °C to 35 °C, crystallizing sesquicarbonate dihydrate sodium carbonate from the trona solution in a solar pond by maintaining the trona solution at a depth of at least 3 feet in the solar pond, for a period in range from 10 weeks to 16 weeks to obtain a crust crystal of sesquicarbonate dihydrate sodium carbonate with mother liquor in interstitial spaces, recovering the crystals of sesquicarbonate dihydrate sodium carbonate from solar pond, and converting the crystals of sesquicarbonate dihydrate sodium carbonate to sodium carbonate. P. O. BOX 785-00618 NAIROBI

.....  
(21) Application no.: KE/P/2025/5446

(22) Filing Date: 06/08/2025 (30) Priority: (51) Int.Cl. A 61P 35/00(2006.01)

(54) Title: MULTI - COMPOUND PHARMACEUTICAL COMPOSITION FOR THE TREATMENT OF CERVICAL CANCER

(72) Inventors: Dr. Amel Elbasyouni; Prof. Mutinda C. Kyama; Dr. Peter G. Mwitari and Prof Hany A. El -

Shemy

(73) Applicant(s): Pan African University Institute of Basic Science Technology and Innovation (PAUSTI) P.O BOX 62000 - 00200 ,NAIROBI , KENYA , Kenya

(74) Agent: ,

(57) The invention relates to a multi-compound pharmaceutical composition comprising eight validated bioactive compounds riboflavin, thymidine 5' -triphosphate, 2-( 4-isobutylphenyl) propionic acid, caffeic acid, L-p-homotryptophan, N-formyl-L-methionine, galactopyranose, and glycyl-Lproline, for the treatment of cervical cancer. Prepared from *Solanecio manni* or validated plant sources, or commercial sources, the formulation demonstrates selective cytotoxicity against cervical cancer cells, with a validated selectivity index of 2.37. Network pharmacology and qPCR analyses confirm multi-target inhibition, including NFKB 1, PIK3CA, HIF 1 A, ST A T3, and HSP90AA 1, among others. The formulation acts through synergistic, multi-pathway mechanisms, inducing apoptosis, DNA damage, endoplasmic reticulum stress, and G2/M cell cycle arrest. It remains effective against HPV -positive and drug-resistant cervical cancer cells. Methods are provided for compound extraction, purification, formulation, and treatment, with options for oral or injectable pharmaceutical compositions. The invention addresses unmet needs in cervical cancer therapy by offering a novel, validated, multi-compound alternative to conventional treatments.

.....  
(21) Application no.: KE/P/2025/5513

(22) Filing Date: 05/09/2025 (30) Priority:

(51) Int.Cl.2018.01 G 06Q 40/00(2012.01)

(54) Title: INTEGRATED FUNERAL WELFARE AND CLAIMS MANAGEMENT SYSTEM

(72) Inventors: JOHN ONYANGO OTOLO

(73) Applicant(s): JOHN ONYANGO OTOLO P.O BOX 11197-00400 NAIROBI, Kenya (

74) Agent: ,

(57) An integrated funeral welfare and claims management system comprising a client-facing member registration application , an administrative claims management platform , and a backend processing engine with compliance and audit modules. **The** system provides real-time member onboarding, contribution tracking, funeral claims verification, and automated benefits disbursement. A unique compliance engine enforces waiting-period rules, fraud detection, and digital record authentication. A multi-level access structure ensures secure handling of member data, while the monitoring dashboard (24) provides performance analytics for decision-making. **The** system enhances transparency, reduces fraud, and ensures dignified, timely funeral support to members and their beneficiaries.

.....  
(21) Application no.: KE/P/2025/5514

(22) Filing Date: 05/09/2025 (30) Priority:

(51) Int.Cl.2018.01 G 06Q 10/00(2012.01)

(54) Title: A SYSTEM AND METHOD FOR ON -DEMAND CAR WASH SERVICES USING A MOBILE APPLICATION AND DISTRIBUTED ORGANIC DATA COLLECTION

(72) Inventors: JOHN ONYANGO OTOLO

(73) Applicant(s): JOHN ONYANGO OTOLO P.O BOX 11197-00400 NAIROBI, Kenya

(74) Agent: ,

(57) 1) A system (10) for on-demand car wash services comprising a client application (12), a service provider application (14), and a backend management system (16), wherein said backend (16) is configured to receive booking requests from the client app (12), assign service providers through a matching algorithm (20), and manage payments and records (2) 2 (3) The system of claim 1, wherein the backend (16) further integrates a distributed data collection module (18) operated by independent field agents for continuous update of service coverage data (4) 3 (5) The system of claim 1 or 2, wherein the quality and compliance layer (22) enforces provider verification, digital receipts, and customer rating-based performance tracking (6) 4 (7) The system of any of the preceding claims, wherein the matching algorithm (20) considers proximity, availability, and service rating (8) 5 (9)

.....  
(21) Application no.: KE/P/2025/5516

(22) Filing Date: 05/09/2025 (30) Priority:

(51) Int.Cl. G 06Q 10/047(20230101) (54) Title: METHOD AND SYSTEM FOR AIRCRAFT FLEET ROUTING OPTIMIZATION USING MEMETRIC EVOLUTION AND DOMAIN-CONSTRAINED LOCAL SEARCH (72) Inventors: PATEL SAHIL. J.

(73) Applicant(s): PATEL SAHIL. J. P. O. BOX 2139-00606 NAIROBI, Kenya

(74) Agent: ,

(57) A computer-implemented method and system for optimizing aircraft fleet assignments and routing for on-demand flight scheduling. Passenger bookings are mapped to aircraft using **Hybrid Evolutionary-Nested**

**Annealing Search (HENAS)**, which interleaves population-based evolution with embedded simulated annealing and a nested hierarchical annealing refinement under time, fuel, and weight constraints. A penalty-based feasibility engine ensures compliance. After initial optimization, passenger transfers and overnight parking are planned to reduce fuel consumption and improve schedule alignment. Historical best routes are cached for reuse, and parallel processing accelerates evaluation, yielding a scalable, adaptive alternative to manual dispatch planning.

.....  
(21) Application no.: KE/P/2025/5538  
(22) Filing Date: 15/09/2025  
(30) Priority: (51) Int.Cl.2018.01 B 63H 21/20(2006.01)  
(54) Title: HYBRID SOLAR POWERED BOAT SYSTEM  
(72) Inventors: SCHOUT ARTHUR (73) Applicant(s): MIRERI SANTANA PRISCA P.O Box 24664-0100 NAIROBI-GPO, Kenya  
(74) Agent: AARON O.& ASSOCIATES ADVOCATES,  
(57) The invention relates to a solar-powered and hybrid solar-powered boat designed for sustainable water transport. It vessel incorporates photovoltaic solar arrays mounted on the canopy to capture solar energy, which is regulated by a charge controller and stored in a lithium-ion battery bank secured within the hull. The stored energy powers an electric motor at the stern connected to the propeller shaft, with a control console enabling drive mode management. The system allows for fully autonomous operation using onboard solar power or semiautonomous operation through shore-based battery charging stations with either battery exchange or cable charging. Additionally, a hybrid configuration is provided where a fossil fuel Internal Combustion Engine (ICE) can operate either to drive the propeller shaft directly (Power Take-In mode) or as a generator supplying electricity to the motor. This integrated design enhances flexibility, reduces emissions, and ensures operational reliability in marine transport applications.P.O BOX 24664-00100, GPO NAIROBI SUITES 31, COURT 176, NYAYO APARTMENTS, FANAKA NORTH CRESCENT ROAD, EMBAKASI, P.O BOX 24664-00100, GPO NAIROBI

.....  
(21) Application no.: KE/P/2025/5822  
(22) Filing Date: 15/12/2025 (30) Priority:  
(51) Int.Cl. C 12N 1/00(2006.01), A 61K 36/06(2006.01), A 61K 39/00(2006.01)  
(54) Title: ANTIFUNGAL COMPOSITION AND METHODS OF PREPARATION AND USE THEREOF (72) Inventors: XIE YUKUN  
(73) Applicant(s): XIE YUKUN P. O. Box 31519, 00600, Kilifi, Kenya  
(74) Agent:;  
(57) The present invention relates to a topical antifungal composition and methods of preparation and use thereof. The composition comprises acetylsalicylic acid in an amount of about 5% to about 15% by weight, salicylic acid in an amount of about 5% to about 15% by weight, and a pharmaceutically acceptable alcohol solvent having a purity of at least 90% present in an amount of about 70% to about 90% by volume. The invention further provides a method for preparing the composition comprising sequentially dissolving acetylsalicylic acid and salicylic acid in the alcohol solvent with agitation until complete dissolution is achieved. Additionally, the invention provides a method for treating fungal skin infections including tinea pedis, tinea corporis, tinea cruris, and neurodermatitis by cleansing the affected area and topically applying the composition. The dual salicylate formulation provides synergistic anti-inflammatory, keratolytic, and antifungal effects for effective treatment of dermatophyte infections.

.....  
(21) Application no.: KE/P/2025/5827  
(22) Filing Date: 18/12/2025 (30) Priority:  
(51) Int.Cl. C 12Q 1/70(2006.01), C 12Q 1/68(2018.01)  
(54) Title: BRANCHED HCR-BASED DETECTION OF HPV 16/35 E6 MRNA VIA MULTIMODAL METHODS (72) Inventors: VICTORIA KIWASI MWAENI; PROF CLEOPHAS MUTINDA KYAMA and DOROTHY NYAMAI (73) Applicant(s): PAN AFRICAN UNIVERSITY INSTITUTE FOR BASIC SCIENCES TECHNOLOGY AND INNOVATION JKUAT MAIN CAMPUS-JUJA, 00200, NAIROBI, Kenya (74) Agent: Simon Ng'ang'a Njuguna, (57) Uzima Estate, 01001, Nairobi

.....  
(21) Application no.: KE/P/2026/5842  
(22) Filing Date: 14/01/2026 (30) Priority: KE/UM/2025/3481 25/11/2025 KE  
(51) Int.Cl.2018.01 G 06Q 20/36(2012.01)  
(54) Title: SYSTEM AND APPARATUS FOR REAL-TIME TRANSACTIONAL SIGNAL PARTITIONING AND AUTOMATED DATA ROUTING  
(72) Inventors: BISHAR ABDI and DENNIS MOGONDO NYAMANGA

(73) Applicant(s): DENNIS MOGONDO NYAMANGABISHAR ABDI P.O BOX 71433-00610 NAIROBI, Kenya and P.O BOX 71433-00610 NAIROBI, Kenya

(74) Agent: ,

(57) The invention provides an automated mobile-money value-capture mechanism designed to help users accumulate savings by setting aside small amounts from every outgoing transaction. The system operates on any mobile-money wallet or integrated financial service and uses a logic engine that applies two variables to each transaction: a percentage-based deduction and a flat "coins" amount. When a user initiates a transfer, the mechanism automatically diverts the combined captured value into a separate user-owned holding wallet before the transaction is completed. This interception ensures the savings are secured at the point of transfer without requiring additional user action. The solution may function as an independent application or as an embedded feature within a bank or mobile-money operator platform. By automating micro- savings from routine transactions, the invention enables consistent value accumulation and improved financial discipline for users

.....

## 2.0 Patents Granted under Section 45

### 2.1 National Patents

(11) Patent Number: KE 1081 date of grant: 12/03/2026

(21) Application Number: KE/P/2025/5436 (22) Filing Date:28/07/2025 (30) Priority:

(73) Owner(s): KEVIN MURIITHI MANYARA of 405-60202 NKUBU, Kenya

(72) Inventor(s) KEVIN MURIITHI MANYARA

(74) Agent/address for correspondence:

(54) Title: A COMPUTER IMPLEMENTED METHOD FOR PREDICTING INTERNAL TEMPERATURE DISTRIBUTION OF PACKED FOOD PRODUCTS FROM SURFACE TEMPERATURE SENSORS .

(51) Int.Cl.2018.01: G 01K 7/00(2006.01), G 01K 17/00(2006.01)

(57) Abstract: A system for monitoring and predicting temperature distributions in storage facilities is disclosed. The system comprises at least one modular surface temperature sensor array positioned in contact with packaged or stacked food products, at least one microprocessor configured to receive and process data, and at least one microcontroller controlling sensor operations and array positioning. A machine learning model, executed locally on the microprocessor or remotely on an online server, is trained to correlate surface temperature measurements with internal product centre temperatures . The system further includes a storage medium for storing timestamped thermal data and a graphical user interface providing online access to measured and predicted temperature distributions. The GUI enables users to select regions of interest (ROI) from surface data for model input, enhancing monitoring accuracy, traceability, and food safety in cold storage environments.

.....

(11) Patent Number: KE 1082 date of grant: 13/03/2026

(21) Application Number: KE/P/2025/5427 (22) Filing Date:18/07/2025 (30) Priority:

(73) Owner(s): RONGO UNIVERSITY of 103-40404,RONGO TOWN, Kenya

(72) Inventor(s) Carren Adhiambo Otieno; Francis Olal and Maureen Adoyo

(74) Agent/address for correspondence:

(54) Title: Phytotherapeutic Composition from *Lantana camara* and *Markhamia lutea* Leaf Extracts for the Treatment of Toothache

(51) Int.Cl.2018.01: A 61K 36/185(2006.01), A 61K 36/00(2006.01)

(57) Abstract: This invention discloses a novel plant based phytotherapeutic formulation derived from methanolic extracts of *Lantana camara* and *Markhamia lutea* leaves for the treatment and management of toothache. Phytochemical screening confirmed the presence of bioactive compounds, including tannins, alkaloids, terpenoids, and flavonoids, known for their antimicrobial, anti-inflammatory, and analgesic properties. The formulation demonstrated potent activity against common oral pathogens such as *Streptococcus mutans*, *Staphylococcus aureus*, and *Escherichia coli*. Developed as a topical powder, the composition effectively relieves dental pain while inhibiting microbial growth. Designed to offer a natural, safe, and affordable alternative to conventional synthetic treatments, this invention holds particular relevance for rural and low-resource settings. Additionally, the formulation is adaptable for incorporation into a dual-function toothpaste by combining it with silica (thickener), glycerine (humectant), and an alkali salt (pH stabilizer). This innovation not only modernizes and validates traditional medicinal knowledge through scientific approaches but also presents a scalable, community-driven solution to oral health challenges

## 2.2 ARIPO GRANTED PATENTS

- (11) Patent Number: 8120 date of grant: 13/03/2026  
(21) Application Number: 2017/9985 (22) Filing Date: 21/12/2015  
(30) Priority: 62/095,758 22/12/2014 US  
(73) Owner(s): HELIX ENERGY SOLUTIONS GROUP, INC. of 3505 W. Sam Houston, Parkway North, Suite, Houston , TX 77060, United States of America.  
(72) Inventor(s)  
(74) Agent/Address for service: ADAMS AND ADAMS MOZAMBIQUE, Rua Estevão Ata-de, #20, R/C Bairro da Sommerschild, Maputo, Mozambique  
(54) Title: WELL INTERVENTION MONOHULL VESSEL  
(51) Int.Cl.: E 21B 19/02, E 21B 15/02, E 21B 19/14, B 63B 27/10, B 63B 3/14, B 63B 35/44, B 63B 27/04, B 63B 25/00, B 63B 19/00, B 63B 27/16  
(57) Abstract: A well intervention monohull vessel and method of use including a tower type open derrick disposed on a deck of the vessel and a single point land out. The vessel may also include an intervention riser system, an emergency disconnect package, a moonpool door preferably capable of transporting the intervention riser system, an intervention lift frame, a surface coiled tubing reel, a riser storage area, a rail, a pallet, a subsea tree, a crane, and/or a drawwork  
.....  
(11) Patent Number: 8105 date of grant: 13/03/2026  
(21) Application Number: 2020/12483 (22) Filing Date: 29/11/2018  
(30) Priority:201811428226.6 27/11/2018 CN and 1751489-4 01/12/2017 SE  
(73) Owner(s): ABSOLICON SOLAR COLLECTOR AB of Fiskaregatan 11 871 33 Hårnäsand, Sweden, SE, Sweden  
(72) Inventor(s)  
(74) Agent/Address for service: FISHER CORMACK & BOTHA, P. O. Box 74, Blantyre, Malawi.  
(54) Title: METHOD, ARRANGEMENT AND PRODUCTION LINE FOR MANUFACTURING A PARABOLIC TROUGH SOLAR COLLECTOR(51) Int.Cl.: G 02B 5/10, B 21D 11/20, F 24S 23/74, F 24S 10/40, F 24S 20/20  
(57) Abstract: An arrangement (600) for manufacturing a reflector for a PTC from a rectangular reflective structure. The arrangement comprises a tensioning device (604) configured to tension a reflector portion of the rectangular reflective structure, such that a surface of the tensioned reflector portion acquires a curvature perpendicular to the tensioned reflector portion's longitudinal propagation, along the tensioned reflector portion's longitudinal propagation. The arrangement (600) further comprises a fixating device (606) configured to fixate the surface's curvature, such that the tensioned reflector portion remains tensioned. The tensioning device (604) is configured to tension the reflector portion of the rectangular reflective structure by pre-forming the reflector portion to a pre-curvature, and adjusting the pre-curvature by applying a torque at a longitudinal borderline of the pre-formed portion. Because the reflector will be maintained tensioned by torques only, it will adapt a curvature of a high precision parabola.  
.....  
(11) Patent Number: 8111 date of grant: 13/03/2026  
(21) Application Number: 2021/13683 (22) Filing Date: 12/06/2020  
(30) Priority:62/861,708 14/06/2019 US  
(73) Owner(s): TENEOBIO, INC. of 7999 Gateway Blvd. Suite 320 Newark, California 94560, United States of America.  
(72) Inventor(s)  
(74) Agent/Address for service: FISHER CORMACK & BOTHA, P. O. Box 74, Blantyre, Malawi  
(54) Title: MULTISPECIFIC HEAVY CHAIN ANTIBODIES BINDING TO CD22 AND CD3  
(51) Int.Cl.: C 07K 16/28, A 61P 35/00  
(57) Abstract: Multispecific, human heavy chain antibodies (e.g., UniAbs<sup>®</sup>,<sup>®</sup>) binding to CD22 and CD3 are disclosed, along with methods of making such antibodies, compositions, including pharmaceutical compositions, comprising such antibodies, and their use to treat disorders that are characterized by the expression of CD22.  
.....  
(11) Patent Number: 8142 date of grant: 13/02/2026  
(21) Application Number: 2021/13700 (22) Filing Date: 12/06/2020  
(30) Priority:2023294 12/06/2019 NL and 2024761 27/01/2020 NL  
(73) Owner(s): PERFO TEC B.V. of Klompenmakersweg 16, 3449 JB Woerden, The Netherlands.  
(72) Inventor(s)  
(74) Agent/Address for service: ADAMS AND ADAMS MOZAMBIQUE, Rua Estevão Ata-de, #20, R/C Bairro da Sommerschild, Maputo, Mozambique  
(54) Title: PACKAGE FOR PRESERVING RESPIRING PRODUCE AND METHOD

(51) Int.Cl.: B 65D 81/20, B 65D 85/50, B 65D 85/34

(57) Abstract: A package for preserving respiring produce contained in the package, in particular vegetables, fruit, herbs, spices and/or flowers, and an associated method are provided. The package defines a package volume for containing a portion of the produce and a package atmosphere, and comprises a packaging material, in particular a polymer film (1A), provided with at least one perforation (3) enabling gas exchange with the atmosphere surrounding the package (1) to form the package into a Controlled Atmosphere Package (CAP). The packaging material has a Water Vapour Transmission Rate (WVTR), a carbon dioxide transmission rate (CO

.....  
(11) Patent Number: 8110 date of grant: 13/03/2026

(21) Application Number: 2022/13759 (22) Filing Date: 30/10/2017

(30) Priority:201631037704 04/11/2016 IN

(73) Owner(s): UPL LTD of Agrochemical Plant, Durgachak, Midnapore Dist. West Bengal, Haldia 721 602, India.

(72) Inventor(s)

(74) Agent/Address for service: ADAMS AND ADAMS MOZAMBIQUE, Rua Estevão Ata-de, #20, R/C Bairro da Sommerschild, Maputo, Mozambique

(54) Title: FUNGICIDAL COMBINATIONS

(51) Int.Cl.: A 01N 37/50, A 01N 43/50, A 01N 43/54, A 01N 43/56, A 01N 43/653, A 01N 47/14, A 01P 3/00

(57) Abstract: A combination comprising a dithiocarbamate fungicide, a succinate dehydrogenase fungicide and at least one of ergosterol biosynthesis inhibitor fungicide or a quinone outside inhibitor fungicide.

.....  
(11) Patent Number: 8106 date of grant: 13/03/2026

(21) Application Number: 2022/13855 (22) Filing Date: 07/08/2019

(30) Priority:

(73) Owner(s): NOKIA TECHNOLOGIES OY of Karakaari 7, 02610 Espoo, Finland, FI, Finland

(72) Inventor(s)

(74) Agent/Address for service: GALLOWAY & COMPANY, P. O. Box A761, Avondale, Harare, Zimbabwe.

(54) Title: SHARING HARQ PROCESSES BY MULTIPLE CONFIGURED GRANTS RESOURCES

(51) Int.Cl.: H 04L 1/18, H 04W 72/14, H 04W 72/04

(57) Abstract: Embodiments of the present disclosure relate to mechanism for sharing HARQ processes by multiple configured grant resources. According to embodiments of the present disclosure, multiple configured grant resources share a common pool of HARQ processes. The network device transmits information concerning the multiple configured grants resources and the common pool HARQ process to the terminal device. Further, for one of the multiple configured grant resources, the terminal device selects a HARQ process from the common pool of HARQ processes. In this way, the throughput has improved and the low latency for high priority data is ensured.

.....  
(11) Patent Number: 8130 date of grant: 13/02/2026

(21) Application Number: 2022/13869 (22) Filing Date: 28/02/2022

(30) Priority:202141009024 IN

(73) Owner(s): INDIAN INSTITUTE OF SCIENCE of Sir C. V. Raman Road, Bangalore -560012, Karnataka, India, India (72) Inventor(s)

(74) Agent/Address for service: ADAMS AND ADAMS MOZAMBIQUE, Rua Estevão Ata-de, #20, R/C Bairro da Sommerschild, Maputo, Mozambique.

(54) Title: METHODS FOR IDENTIFYING HAEMOGLOBIN S OR C IN A BIOLOGICAL SAMPLE AND KITS THEREOF

(51) Int.Cl.:

(57) Abstract: "Methods for identifying haemoglobin S or C in a biological sample and kits thereof"; The present disclosure provides in vitro methods for identifying the presence or absence of haemoglobin S (HbS) or haemoglobin C (HbC) in a blood sample, kits and devices thereof. The inventors have found that HbS shows a substantial decrease in absorption under deoxygenated conditions compared to oxygenated conditions. The inventors expect HbC to show a similar decrease in absorption under deoxygenated conditions compared to oxygenated conditions. The methods, kits and devices of the disclosure employ this decrease in absorption under deoxygenated conditions to identify the presence or absence of HbS or HbC in a blood sample. The methods, kits and devices of the present disclosure are simple, low cost, and provide a rapid way to identify the presence or absence of HbS or HbC in a blood sample in a point-of-care setting.

.....  
(11) Patent Number: 8149 date of grant: 13/02/2026

(21) Application Number: 2022/13939 (22) Filing Date: 01/10/2020

(30) Priority: 201941039822 01/10/2019 IN

(73) Owner(s): UPL CORPORATION LIMITED of 5th Floor Newport Building, Louis Pasteur Street, Port Louis, Mauritius, Maritius and UPL EUROPE LTD of The Centre, 1st floor Birchwood Park, Warrington, Cheshire WA3 6YN, United Kingdom.

(72) Inventor(s)

(74) Agent/Address for service: ADAMS AND ADAMS MOZAMBIQUE, Rua Estevão Ata-de, #20, R/C Bairro da Sommerschild, Maputo, Mozambique

(54) Title: HERBICIDE COMPOSITIONS

(51) Int.Cl.: A 01N 37/26, A 01N 43/50, A 01N 43/56, A 01N 43/653, A 01N 43/90, A 01N 47/36, A 01N 47/38, A 01P 13/00

(57) Abstract: The present invention relates to herbicidal combinations. More specifically, the subject of this invention relates to a combination of shoot growth inhibitor herbicides with amino-acid synthesis inhibitor herbicides for controlling weeds.

.....

(11) Patent Number: 8131 date of grant: 13/02/2026 (21) Application Number: 2022/13945 (22) Filing Date: 02/09/2020 (30) Priority:201921035435 03/09/2019 IN (73) Owner(s): SERUM INSTITUTE OF INDIA PRIVATE LIMITED of 212/2, Off Soli Poonawalla Road, Hadapsar, Pune, Maharashtra 411 028, India. (72) Inventor(s) (74) Agent/Address for service: ADAMS AND ADAMS MOZAMBIQUE, Rua Estevão Ata-de, #20, R/C Bairro da Sommerschild, Maputo, Mozambique (54) Title: IMMUNOGENIC COMPOSITIONS AGAINST ENTERIC DISEASES AND METHODS FOR ITS PREPARATION THEREOF (51) Int.Cl.: A 61K 39/112, A 61P 31/04 (57) Abstract: The present disclosure relates to novel immunogenic monovalent and multivalent polysaccharide-protein conjugate vaccine compositions comprising a polysaccharide selected from

.....

(11) Patent Number: 8112 date of grant: 13/03/2026

(21) Application Number: 2022/13954 (22) Filing Date: 03/12/2019

(30) Priority:201910839962.9 05/09/2019 CN

(73) Owner(s): SHENZHEN TRANSSION HOLDINGS CO., LTD. of Room 1702-1703, Desay Building, No.9789 Shennan Road, Hi-tech Park, Nanshan District, Shenzhen, China.

(72) Inventor(s)

(74) Agent/Address for service: INVENTA MOZAMBIQUE, LDA. Av. 25 de Setembro, 1821 Maputo, Mozambique

(54) Title: CHARGING SYSTEM AND METHOD FOR HANDHELD DEVICES AND TERMINAL DEVICES

(51) Int.Cl. H 01M 10/42, H 02J 7/00

(57) Abstract: Disclosed is a charging system for a handheld device. The charging system comprises a charger and a terminal device, wherein the charger is connected to a USB interface of the terminal device. The terminal device comprises a first charging module, a second charging module, a regulation and control module, the USB interface and a battery module, wherein a control end of the first charging module and a control end of the second charging module are both connected to the regulation and control module; the USB interface is respectively connected to an input end of the first charging module and the regulation and control module; the first charging module comprises an intermediate output end and an output end; and an input end of the second charging module is connected to the intermediate output end of the first charging module, so that a load required by battery charging is allocated to the first charging module and the second charging module for transmission, thereby reducing a heat generation amount and realizing cooling. Further disclosed are a quick charging method and a terminal device.

.....

(11) Patent Number: 8132 date of grant: 13/02/2026 (21) Application Number: 2022/14024 (22) Filing Date: 30/09/2020 (30) Priority:19306297.3 07/10/2019 EP (73) Owner(s): UPL EUROPE LTD of The Center, 1st Floor, Birchwood Park, Warrington Cheshire WA3 6YN, United Kingdom, United Kingdom and UPL MAURITIUS LIMITED of 6th Floor, Suite 157B Harbor Front Building President John Kennedy Street Port Louis, Mauritius.

(72) Inventor(s) (74) Agent/Address for service: ADAMS AND ADAMS MOZAMBIQUE, Rua Estevão Ata-de, #20, R/C Bairro da Sommerschild, Maputo, Mozambique (54) Title: CONCENTRATED ALGAL EXTRACT (51) Int.Cl.: A 01N 65/03, C 05F 11/00, C 05G 5/27, C 12N 1/00 (57) Abstract: The present invention relates to a composition of seaweed algal extracts having a dry matter content between 18-36%. These extracts preferably belong to

.....

(11) Patent Number: 8121 date of grant: 13/03/2026

(21) Application Number: 2022/14139 (22) Filing Date: 01/04/2014

(30) Priority:61/809,028 05/04/2013 US and 61/877,167 12/09/2013 US

(73) Owner(s): DOLBY LABORATORIES LICENSING CORPORATION of 100 Potrero Avenue San Francisco, California 94103-4813, United States of America, US, U.S.A. and DOLBY INTERNATIONAL AB of Apollo Building, 3E, Herikerbergweg 1-35, NL-1101 CN Amsterdam Zuidoost, The Netherlands.

(72) Inventor(s)

(74) Agent/Address for service: FISHER CORMACK & BOTHA, P. O. Box 74, Blantyre, Malawi  
(54) Title: COMPANDING APPARATUS AND METHOD TO REDUCE QUANTIZATION NOISE USING ADVANCED SPECTRAL EXTENSION

(51) Int.Cl.: G 03G 7/00, H 03G 3/24, H 04B 1/64, G 10L 21/034

(57) Abstract: Embodiments are directed to a companding method and system for reducing coding noise in an audio codec. A compression process reduces an original dynamic range of an initial audio signal through a compression process that divides the initial audio signal into a plurality of segments using a defined window shape, calculates a wideband gain in the frequency domain using a non-energy based average of frequency domain samples of the initial audio signal, and applies individual gain values to amplify segments of relatively low intensity and attenuate segments of relatively high intensity. The compressed audio signal is then expanded back to substantially the original dynamic range that applies inverse gain values to amplify segments of relatively high intensity and attenuating segments of relatively low intensity. A QMF filterbank is used to analyze the initial audio signal to obtain a frequency domain representation.

.....  
(11) Patent Number: 8104 date of grant: 13/03/2026 (21) Application Number: 2022/14162 (22) Filing Date: 04/12/2020 (30) Priority:62/944,869 06/12/2019 US (73) Owner(s): VERTEX PHARMACEUTICALS INCORPORATED of 50 Northern Avenue Boston, MA 02210, United States of America. (72) Inventor(s) (74) Agent/Address for service: FISHER CORMACK & BOTHA, P. O. Box 74, Blantyre, Malawi (54) Title: SUBSTITUTED TETRAHYDROFURANS AS MODULATORS OF SODIUM CHANNELS (51) Int.Cl.: C 07D 405/14, C 07D 405/12, A 61K 31/443, A 61P 29/00 (57) Abstract: Compounds, and pharmaceutically acceptable salts thereof, useful as inhibitors of sodium channels are provided. Also provided are pharmaceutical compositions comprising the compounds or pharmaceutically acceptable salts and methods of using the compounds, pharmaceutically acceptable salts, and pharmaceutical compositions in the treatment of various disorders, including pain.

.....  
(11) Patent Number: 8109 date of grant: 13/03/2026  
(21) Application Number: 2022/14172 (22) Filing Date: 27/11/2020  
(30) Priority:201921048627 27/11/2019 IN  
(73) Owner(s): PETROLEUM CONSERVATION RESEARCH ASSOCIATION of Petroleum Conservation Research Association, Sanrakshan Bhavan, 10 - Bhikaiji Cama Place New Delhi 110066, India, India and BHARAT PETROLEUM CORPORATION LIMITED of Bharat Bhavan, 4 & 6 Currimbhoy Road, Ballard Estate, Mumbai, Maharashtra 400001, India.

(72) Inventor(s)  
(74) Agent/Address for service: ADAMS AND ADAMS MOZAMBIQUE, Rua Estevão Ata-de, #20, R/C Bairro da Sommerschild, Maputo, Mozambique

(54) Title: A DOMESTIC COOKING STOVE FOR COMBUSTION OF LPG FUEL WITH HIGH THERMAL EFFICIENCY

(51) Int.Cl.: F 24C 3/08, F 24C 15/10

(57) Abstract: A domestic cooking stove comprises a frame that mounts a primary tube, one or more of nozzles for fuel injection, knobs for controlling the fuel injection, mixing tubes for modulating pressure gradient, burner tops for combustion of the air fuel mixture, and pan supports to support the vessel, heat reflectors to reflect heat, and legs to support the frame. Each heat reflector is positioned above burner top to provide secondary air entrainment for combustion by reducing a gap between an inner circumference of heat reflector and an outer circumference of the burner top to minimize heat losses. The heat reflector has a curved orientation to reduce heat transfer in a downward direction and generates eddies that increases heat transfer towards vessel bottom. The legs are positioned below the frame and has a predetermined height to maintain a gap between table top and the frame bottom surface for entrainment of air.

.....  
(11) Patent Number: 850 date of grant: 13/02/2026  
(21) Application Number: 2022/14182 (22) Filing Date: 17/12/2019  
(30) Priority: (73) Owner(s): MAIA AFRICA SAS of Rue 29.20 12 BP 499 Ouagadougou 12, Burkina Faso.  
(72) Inventor(s)

(74) Agent/Address for service: ADAMS AND ADAMS MOZAMBIQUE, Rua Estevão Ata-de, #20, R/C Bairro da Sommerschild, Maputo, Mozambique

(54) Title: LONG PROTECTION MOSQUITO REPELLENT OINTMENT

(51) Int.Cl.: A 01N 25/04, A 01N 37/18, A 01P 17/00

(57) Abstract: The invention relates to an ointment comprising shea butter, petrolatum, beeswax, perfume and 10 to 20% by weight of DEET based on the total weight of the ointment, providing a protection against mosquitoes for at least 7 hours, its uses as a mosquito repellent and for the prevention of diseases such as malaria, and its manufacturing process.

.....  
(11) Patent Number: 8107 date of grant: 13/03/2026

(21) Application Number: 2022/14218 (22) Filing Date: 23/11/2020  
(30) Priority:202010069718.1 21/01/2020 CN  
(73) Owner(s): BEIJING TENHE ELECTRONIC TECHNOLOGY CO. , LTD. of Room 209, second floor, building A2, NO.18, Changsheng Road, Science Park, Changping District, Beijing, China.  
(72) Inventor(s)  
(74) Agent/Address for service: FISHER CORMACK & BOTHA, P. O. Box 74, Blantyre, Malawi  
(54) Title: METHOD AND SYSTEM FOR ANALYZING ERROR OF MEASUREMENT DOMAIN BASED ON SINGLE LOAD JUMP, AND STORAGE MEDIUM (51) Int.Cl.: G 01R 35/04  
(57) Abstract: A single load jump-based method and system for performing an error analysis on a measurement domain, and a computer-readable storage medium. According to the method and system, a high-density measurement is performed on the loads of a master meter and sub-meters in a measurement domain for a long time, so as to obtain massive load data; then the load measurement differences, before and after jumping, of the master meter and a sub-meter to which jumping occurs are acquired on the basis of the situation of a single load jump; an error deviation of the sub-meter to which jumping occurs relative to the master meter is uniquely defined; and after having obtained statistical data of error deviations of all the sub-meters relative to the master meter, error analysis is performed on the whole measurement domain on the basis of the statistical data (S4), so that an overall error state of the measurement domain, an error state of the master meter and an error state of each sub-meter can be accurately evaluated. The invention is worthy of being widely popularized. Moreover, the error deviation is calculated on the basis of the load measurement differences before and after jumping, so that the influence of an influence quantity error on the calculation result is eliminated, and the calculation result is more accurate.

.....  
(11) Patent Number: 8135 date of grant: 13/03/2026  
(21) Application Number: 2022/14252 (22) Filing Date: 05/02/2021  
(30) Priority:PCT/CN2020/074537 07/02/2020 CN and PCT/CN2020/109304 14/08/2020 CN  
(73) Owner(s): GASHERBRUM BIO, INC. of 2145 Clement St., San Francisco, California 94121, United States of America. (72) Inventor(s)  
(74) Agent/Address for service: ADAMS AND ADAMS MOZAMBIQUE, Rua Estevão Ata-de, #20, R/C Bairro da Sommerschild, Maputo, Mozambique  
(54) Title: HETEROCYCLIC GLP-1 AGONISTS  
(51) Int.Cl.: C 07D 471/04, C 07F 9/53, A 61K 31/4709, A 61K 31/444, A 61K 31/4725, A 61K 33/42, A 61K 31/437, A 61P 9/00, A 61P 3/10, A 61P 3/06, A 61P 3/04  
(57) Abstract: This disclosure relates to GLP-1 agonists of Formula (I) : including pharmaceutically acceptable salts and solvates thereof, and pharmaceutical compositions including the same.

.....  
(11) Patent Number: 8132 date of grant: 13/03/2026  
(21) Application Number: 2022/14302 (22) Filing Date: 17/03/2021  
(30) Priority:62/990,519 17/03/2020 US  
(73) Owner(s): FMC CORPORATION of 2929 Walnut Street, Philadelphia, PA 19104, United States of America.  
(72) Inventor(s)  
(74) Agent/Address for service: FISHER CORMACK & BOTHA, P. O. Box 74, Blantyre, Malawi  
(54) Title: PROCESSES FOR PREPARING SUSPENSION CONCENTRATE FORMULATIONS COMPRISING PESTICIDAL MIXTURES  
(51) Int.Cl.: A 01N 25/04, A 01N 43/56, A 01N 43/653, A 01N 47/24, A 01N 47/38, A 01N 51/00, A 01N 57/16, A 01N 53/00, A 01P 7/02, A 01P 3/00, A 01P 7/04  
(57) Abstract: Described herein are processes for preparing aqueous suspensions of organic pesticides. The processes include inducing crystallization of an amorphous organic pesticide with a crystalline organic pesticide where the crystalline organic pesticide and amorphous organic pesticide are not identical. Also described herein are aqueous pesticide formulations including the prepared aqueous suspensions.

.....  
(11) Patent Number: 8113 date of grant: 13/03/2026  
(21) Application Number: 2022/14533 (22) Filing Date: 04/05/2021  
(30) Priority:2006581.9 04/05/2020 GB and 2016894.4 23/10/2020 GB  
(73) Owner(s): BIO-DIAGNOSTICS LIMITED of Upton Industrial Estate, Rectory Road, Upton-Upon-Severn, Worcestershire WR8 OLX, United Kingdom, United Kingdom  
(72) Inventor(s)  
(74) Agent/Address for service: ROLAND INTELLECTUAL PROPERTY CONSULTANTS, 3 Maritz Street, Windhoek, P. O. Box 91198, Windhoek, Namibia (  
(54) Title: A DIAGNOSTIC DEVICE  
(51) Int.Cl.: B 01L 3/00, G 01N 33/569, G 01N 33/543

(57) Abstract: A diagnostic device (1) for detecting a first member of a reporter-analyte pair. The diagnostic device comprises an inlet for receiving a liquid, biological sample and a porous membrane element (10) comprising a detection portion. The detection portion is in liquid communication with the inlet and a second member of the reporter-analyte pair is immobilised on the detection portion. One of the first or second member of the reporter-analyte pair comprises a biological antigen and the other of the first or second member of the reporter-analyte pair comprises an antibody specific for the biological antigen. The biological antigen comprises a spike protein, or a fragment thereof, of COVID-19. The device is for independent detection of the spike protein, or the fragment thereof, or of an antibody specific for the spike protein, or the fragment thereof, in the biological sample.

.....

(11) Patent Number: 8113 date of grant: 13/03/2026

(21) Application Number: 2022/14533 (22) Filing Date: 04/05/2021

(30) Priority:2006581.9 04/05/2020 GB and 2016894.4 23/10/2020 GB

(73) Owner(s): BIO-DIAGNOSTICS LIMITED of Upton Industrial Estate, Rectory Road, Upton-Upon-Severn, Worcestershire WR8 OLX, United Kingdom.

(72) Inventor(s)

(74) Agent/Address for service: ROLAND INTELLECTUAL PROPERTY CONSULTANTS, 3 Maritz Street, Windhoek, P. O. Box 91198, Windhoek, Namibia

(54) Title: A DIAGNOSTIC DEVICE

(51) Int.Cl.: B 01L 3/00, G 01N 33/569, G 01N 33/543

(57) Abstract: A diagnostic device (1) for detecting a first member of a reporter-analyte pair. The diagnostic device comprises an inlet for receiving a liquid, biological sample and a porous membrane element (10) comprising a detection portion. The detection portion is in liquid communication with the inlet and a second member of the reporter-analyte pair is immobilised on the detection portion. One of the first or second member of the reporter-analyte pair comprises a biological antigen and the other of the first or second member of the reporter-analyte pair comprises an antibody specific for the biological antigen. The biological antigen comprises a spike protein, or a fragment thereof, of COVID-19. The device is for independent detection of the spike protein, or the fragment thereof, or of an antibody specific for the spike protein, or the fragment thereof, in the biological sample.

.....

(11) Patent Number: 8143 date of grant: 13/02/2026

(21) Application Number: 2022/14584 (22) Filing Date: 19/05/2021

(30) Priority:2020104396569 22/05/2020 CN; 16/881,902 22/05/2020 US and 17/022,745 16/09/2020 US

(73) Owner(s): P2W LTD. of 8 Hametzuda Street, 5800152 Azor, Israel.

(72) Inventor(s)

(74) Agent/Address for service: ADAMS AND ADAMS MOZAMBIQUE, Rua Estevão Ata-de, #20, R/C Bairro da Sommerschild, Maputo, Mozambique

(54) Title: ZLD (ZERO LIQUID DISCHARGE) WASTEWATER TREATMENT

(51) Int.Cl.: B 01D 61/02, B 01D 61/14, B 01J 8/00, C 02F 1/00, C 02F 1/52, C 02F 9/00

(57) Abstract: Methods and systems are provided for wastewater treatment that yields continuous zero liquid discharge (ZLD). These include pre-treating provided wastewater from any contaminated water source to remove heavy metals, ultra-filtering the pre-treated wastewater to remove suspended and colloidal solids, nano-filtering the ultra-filtered wastewater to yield treated water (with monovalent ions) and a concentrate, treating the concentrate to remove di- and tri-valent elements and other compounds from the concentrate, and to reduce a level of sulfates to a specified level which is above a solubility level of sulfates - to yield returned water, and sludge, mixing the returned water with the provided wastewater before or at the first treatment stage and/or with the pre-treated wastewater before the ultrafiltration, and removing residual water from the sludge to yield removed solids with ZLD. Advantageously, disclosed processes and systems are efficient, cheaper and more sustainable than prior art systems.

.....

(11) Patent Number: 8126 date of grant: 13/03/2026

(21) Application Number: 2023/14629 (22) Filing Date: 04/08/2021

(30) Priority:PCT/CN2020/106760 04/08/2020 CN (73) Owner(s): TELEFONAKTIEBOLAGET LM ERICSSON (PUBL) of SE-164 83 Stockholm, Sweden, SE, Sweden

(72) Inventor(s)

(74) Agent/Address for service: GALLOWAY & COMPANY, P. O. Box A761, Avondale, Harare, Zimbabwe

(54) Title: COVERAGE ENHANCEMENT OF MSG3 AND MSGA TRANSMISSIONS ON PHYSICAL UPLINK SHARED CHANNEL

(51) Int.Cl.: H 04W 74/00, H 04W 72/02

(57) Abstract: A communication device operating in a communications network can determine to transmit

information using repetition to a network node operating in the communications network during a random access, RA, procedure. The communication device can further determine a subset of preambles based on determining to transmit the information using repetition. Responsive to determining the subset of preambles, the communication device can determine a preamble of the subset of preambles to transmit to the network node to indicate a type of the repetition. The communication device can further transmit the preamble to the network node. The communication device can further transmit the information using the type of repetition to the network node.

.....  
(11) Patent Number: 8136 date of grant: 13/03/2026  
(21) Application Number: 2023/14633 (22) Filing Date: 18/06/2021  
(30) Priority:17/351,631 18/06/2021 US and 63/040,810 18/06/2020 US  
(73) Owner(s): AKAGERA MEDICINES, INC. of 5 Essex Street Boxford, Massachusetts 01921, United States of America.  
(72) Inventor(s)  
(74) Agent/Address for service: FISHER CORMACK & BOTHA, P. O. Box 74, Blantyre, Malawi  
(54) Title: OXAZOLIDINONE COMPOUNDS, LIPOSOME COMPOSITIONS COMPRISING OXAZOLIDINONE COMPOUNDS AND METHODS OF USE THEREOF  
(51) Int.Cl.: C 07D 263/20, A 61K 9/127, A 61K 31/422, A 61K 31/4439  
(57) Abstract: Compositions and methods for the treatment of tuberculosis, as well as other mycobacterial and gram positive bacterial infections are disclosed. These compositions contain a highly potent and selective oxazolidinone encapsulated with high efficiency to maximize dosing potential of low toxicity drugs, and are stable in the presence of plasma. The compositions are long circulating and retain their encapsulated drug while in the circulation following intravenous dosing to allow for efficient accumulation at the site of the bacterial or mycobacterial infection. The high doses that can be achieved when combined with the long circulating properties and highly stable retention of the drug allow for a reduced frequency of administration when compared to daily or twice daily administrations of other drugs typically utilized to treat these infections.

.....  
(11) Patent Number: 8138 date of grant: 13/03/2026  
(21) Application Number: 2023/14768 (22) Filing Date: 16/08/2021  
(30) Priority:IN202021035357 17/08/2020 IN  
(73) Owner(s): DOSHI Hiteshkumar Anilkant of 801, Anmol Residency, Opp. Singhania School, Pokharan Road No. 1, Samata Nagar, Thane-400 606, India.  
(72) Inventor(s)  
(74) Agent/Address for service: AT MUZA ATTORNEYS, Plot 10231 Unit 1B Broadhurst, PO Box 45075 Fairgrounds, Gaborone, Botswana  
(54) Title: PESTICIDAL COMPOSITION COMPRISING ELEMENTAL SULPHUR AND CHOLINE SALT OF PELARGONIC ACID  
(51) Int.Cl.: A 01N 37/02, A 01N 57/20, C 01B 17/00  
(57) Abstract: The present invention relate to a pesticidal composition comprising elemental sulphur, choline salt of pelargonic acid, and atleast one agrochemically acceptable excipient. The invention particularly relate to a pesticidal composition comprising elemental sulphur in the range of 1%w/w to 95% w/w of the total composition; choline salt of pelargonic acid present in the range of 0.01% to 50% w/w of the total composition; and at least one agrochemically acceptable excipient. The pesticidal composition comprises particles in the size range of 0.1 micron to 50 microns. The present invention also relates to process of preparation of the pesticidal composition. The invention relates to a method of treating a plant, crop, plant propagation material, locus or parts thereof, a seed, seedling or surrounding soil with a pesticidal composition.

.....  
(11) Patent Number: 8091 date of grant: 19/01/2026  
(21) Application Number: 2023/14794 (22) Filing Date: 01/10/2021  
(30) Priority:BR 10 2020 020168 9 01/10/2020 BR and BR 10 2021 019763 3 01/10/2021 BR  
(73) Owner(s): UPL CORPORATION LIMITED of 6th Floor, Suite 157B, Harbor Front Building, President John Kennedy Street, Port Louis, Mauritius, Maritius and UPL DO BRASIL INDUSTRIA E COMERCIO DE INSUMOS AGROPECUARIOS S.A. of Avenida Maeda, s/nÂ°, PrÃ©dio Comercial, tÃ©rreo, Distrito Industrial, 14500-000 Ituverava, Brazil.  
(72) Inventor(s)  
(74) Agent/Address for service: ADAMS AND ADAMS MOZAMBIQUE, Rua EstevÃ£o AtaÃ©-de, #20, R/C Bairro da Sommerschild, Maputo, Mozambique  
(54) Title: PHOTOSTABLE COMPOSITION AND METHOD OF REDUCING OR CONTROLLING WEED POPULATION APPLYING SAID COMPOSITION

(51) Int.Cl.: A 01N 25/22, A 01N 47/38, A 01N 43/653

(57) Abstract: The present invention discloses a photostable composition and method of reducing or controlling weed population applying said composition. The present invention provides compositions of triazolone herbicides protected from photodamage with the help of photoprotective agents.

.....  
(11) Patent Number: 8141 date of grant: 12/02/2026

(21) Application Number: 2023/14842 (22) Filing Date: 23/09/2021

(30) Priority:2015521.4 30/09/2020 GB

(73) Owner(s): CIRCLETECH LIMITED of Suite 3.01, 16 Berkeley Street, London, Greater London W1J 8DZ, United Kingdom.

(72) Inventor(s)

(74) Agent/Address for service: ROLAND INTELLECTUAL PROPERTY CONSULTANTS, 3 Maritz Street, Windhoek, P. O. Box 91198, Windhoek, Namibia

(54) Title: GAS FLOW SENSOR ASSEMBLY, AND SEMICONDUCTOR GAS FLOW SENSOR AND METHOD OF FORMING A SEMICONDUCTOR GAS FLOW SENSOR

(51) Int.Cl.: G 01F 1/68, G 01F 1/692, G 01F 1/688, G 01F 1/684

(57) Abstract: There is described a gas flow sensor assembly for measuring gas flow rate. The gas flow sensor assembly comprises a by-pass tube for coupling to a main tube, a gas flow sensor comprising a heater and at least one temperature sensor adjacent the heater, and a control unit coupled to the at least one temperature sensor. The by-pass tube provides a by-pass passage for a flow of a portion of gas flowing in a main passage of the main tube. The gas flow sensor is positioned in relation to the by-pass tube such that in operation the heater is configured to provide heat to a portion of the by-pass passage and the at least one temperature sensor is configured to provide an output signal representing temperature in the by-pass passage sensed by the at least one temperature sensor. The control unit is configured to determine a change in temperature due to gas flow in the by-pass passage based on output signals from the at least one temperature sensor, and is configured to determine a gas flow rate based on the determined change in temperature. There is further described a semiconductor gas flow sensor, and a method of forming a semiconductor gas flow sensor.

.....  
(11) Patent Number: 8116 date of grant: 13/03/2026

(21) Application Number: 2023/14900 (22) Filing Date: 18/11/2021

(30) Priority:20208567.6 19/11/2020 EP

(73) Owner(s): IGAS ENERGY GMBH of CockerillstraÅe 100 52222 Stolberg, Germany.

(72) Inventor(s)

(74) Agent/Address for service: FISHER CORMACK & BOTHA, P. O. Box 74, Blantyre, Malawi

(54) Title: HYBRID POWER PLANT FOR AUTONOMOUSLY SUPPLYING ENERGY TO BUILDINGS AND INDUSTRIAL FACILITIES

(51) Int.Cl.: C 10B 53/02, C 10J 1/20, C 10J 1/24, C 10L 9/08, C 25B 1/04, C 25B 15/08

(57) Abstract: The invention relates to a hybrid power plant for autonomously supplying energy to buildings, in particular residential buildings, and industrial facilities which are arranged in an area that comprises a source of biomass. The hybrid power plant is preferably arranged in the vicinity of buildings and industrial facilities to be supplied in order to provide energy locally. The hybrid power plant comprises at least one system for generating power from renewable energy sources and a power-to-X device for thermochemically converting electricity from renewable energy sources and biomass into other energy carriers which are stored and converted back into electricity on demand. In order to supply energy to the buildings and industrial facilities to be supplied during dark doldrums, the hybrid power plant comprises one or more energy storage devices and at least one system for converting energy back into electricity. The supply of energy to buildings or industrial facilities by means of the hybrid power plant is climate and CO

.....  
(11) Patent Number: 8108 date of grant: 13/03/2026

(21) Application Number: 2023/14981 (22) Filing Date: 07/01/2021

(30) Priority: (73) Owner(s): NOKIA TECHNOLOGIES OY of Karakaari 7, 02610 Espoo, Finland.

(72) Inventor(s)

(74) Agent/Address for service: GALLOWAY & COMPANY, P. O. Box A761, Avondale, Harare, Zimbabwe

(54) Title: BEAM MANAGEMENT FOR A DEVICE IN AN INACTIVE MODE

(51) Int.Cl.: H 04W 72/04

(57) Abstract: Example embodiments of the present disclosure relate to transmit power control for beam management. The first device transmits a first configuration to a second device. The first configuration indicates information about at least one candidate beam assigned to the second device. Alternatively, or in addition, the first configuration further indicates a correspondence between the at least one candidate beam and a plurality of transmission occasions, where the plurality of transmission occasions are allocated by the

first device for transmission from the second device to the first device while the second device is in an inactive mode. The first device detects transmissions from the second device according to the first configuration at the plurality of transmission occasions. Through this solution, a beam management solution and efficient resource configuration for a device in an inactive mode is proposed.

.....  
(11) Patent Number: 8115 date of grant: 13/03/2026  
(21) Application Number: 2023/15035 (22) Filing Date: 29/03/2022  
(30) Priority:17/301,370 31/03/2021 US  
(73) Owner(s): NOKIA TECHNOLOGIES OY of Karakaari 7, 02610 Espoo, Finland.  
(72) Inventor(s)  
(74) Agent/Address for service: GALLOWAY & COMPANY, P. O. Box A761, Avondale, Harare, Zimbabwe  
(54) Title: EXPLOITATION OF TRANSMITTER (TX) POWER FOR EACH BAND DUAL UP-LINK (UL) CARRIER AGGREGATION (CA)  
(51) Int.Cl.: H 04W 52/36  
(57) Abstract: Various techniques are provided for a method including receiving, at a network device from a user equipment (UE), an indication

.....  
(11) Patent Number: 8134 date of grant: 13/02/2026  
(21) Application Number: 2023/15062 (22) Filing Date: 11/08/2023  
(30) Priority:2022/09259 18/08/2022 ZA (73) Owner(s): CONLOG (PTY) LTD of 10 Mzimkhulu Drive, Dube Trade Port, La Mercy, 4407, South Africa.  
(72) Inventor(s)  
(74) Agent/Address for service: FISHER CORMACK & BOTHA, P. O. Box 74, Blantyre, Malawi  
(54) Title: A VALVE (51) Int.Cl.:  
(57) Abstract: A valve includes a housing with a central bore, a lead screw, a fluid inlet and outlet, and a barrier inside the housing that partially obstructs fluid flow. A flexible diaphragm with inlet bleed holes is movable towards a closed position where it contacts a valve sealing face on the barrier, preventing fluid from flowing from the inlet to the outlet. A fluid outlet bleed port controls fluid flow from an outlet cavity to the fluid outlet. A valve stem and a connected outlet bleed port seal move within the bore towards and away from a valve sealing face. A motor moves these towards the valve sealing face, causing fluid pressure to build up in the outlet cavity which moves the flexible diaphragm to its closed position. The valve stem holds the flexible diaphragm in the closed position when it is closed.

.....  
(11) Patent Number: 8147 date of grant: 13/02/2026  
(21) Application Number: 2023/15200 (22) Filing Date: 26/03/2021 (30) Priority: (73) Owner(s): NOKIA TECHNOLOGIES OY of Karakaari 7, 02610 Espoo, Finland. (72) Inventor(s) (74) Agent/Address for service: GALLOWAY & COMPANY, P. O. Box A761, Avondale, Harare, Zimbabwe (54) Title: METHODS, APPARATUSES, AND COMPUTER READABLE MEDIA FOR CONFIGURING MEASUREMENT GAP PATTERNS (51) Int.Cl.: H 04W 24/10, H 04W 24/00 (57) Abstract: Disclosed are methods for configuring measurement gap patterns. An example method may include: receiving configuration information associated with a plurality of pre-configured measurement gap patterns; receiving index information for configuring at least one measurement gap pattern of a bandwidth part; and configuring the at least one measurement gap pattern of the bandwidth part based on at least one of the configuration information and the index information. Related apparatuses and computer readable media are also disclosed.

.....  
(11) Patent Number: 8134 date of grant: 13/03/2026  
(21) Application Number: 2023/15258 (22) Filing Date: 14/04/2022  
(30) Priority:2027997 16/04/2021 NL  
(73) Owner(s): GASHOUDERS B.V. of Westervoortsedijk 73 KB, Connectr Shared Office, 6827 AV Arnhem, The Netherlands.  
(72) Inventor(s)  
(74) Agent/Address for service: HONEY & BLANCKENBERG, 200 Herbert Chitepo Avenue, Harare, Zimbabwe  
(54) Title: COMPRESSION OF A BIOGAS CONTAINING CARBON DIOXIDE, COMPRESSED BIOGAS CONTAINING CARBON DIOXIDE, AND USE THEREOF  
(51) Int.Cl.: C 10L 3/10, C 10L 3/08  
(57) Abstract: The invention is directed to a process of preparing a compressed fuel, to a compressed fuel, and to the use of a compressed fuel comprising methane and carbon dioxide. The process of the invention comprises - providing a biogas; - removing one or more components from the biogas to obtain a purified biogas, wherein the purified biogas has a methane content of 30 mol% or more and a carbon dioxide content of 10 mol% or more, and - compressing the purified biogas to a pressure of 70 bara or more to form a

compressed fuel.

.....  
(11) Patent Number: 8137 date of grant: 13/03/2026  
(21) Application Number: 2023/15304 (22) Filing Date: 02/05/2022  
(30) Priority:21172982.7 10/05/2021 EP  
(73) Owner(s): SANDVIK MINING AND CONSTRUCTION AUSTRALIA (PRODUCTION/SUPPLY) PTY LTD of Level 5, 135 Coronation Drive, Milton, Queensland 4064, Australia.  
(72) Inventor(s)  
(74) Agent/Address for service: ADAMS AND ADAMS MOZAMBIQUE, Rua Estevão Ata-de, #20, R/C Bairro da Sommerschild, Maputo, Mozambique  
(54) Title: SENSOR ASSEMBLY FOR USE BETWEEN A GROUND ENGAGING TOOL AND A BUCKET  
(51) Int.Cl.: G 01B 21/16, E 02F 9/26, E 02F 9/28  
(57) Abstract: A sensor assembly (1) for attachment to a ground engaging tool (2), wherein the sensor assembly comprises an inner case (3) and an outer case (4), wherein the inner case (3) houses a sensor (5) configured to measure a gap (6) to an adjacent surface, wherein the outer case (4) is provided with a first cavity (7) for receiving the inner case (3) through an opening of the first cavity (7) such that the inner case (3) is movably guided in the outer case (4) for movement into and out of the outer case (4) along a predetermined path of movement (8), and wherein the sensor assembly (1) comprises a biasing means (9) adapted to bias the inner case (3) in a direction out of the outer case (4) along said predetermined path of movement (8).

.....  
(11) Patent Number: 8136 date of grant: 03/02/2026  
(21) Application Number: 2024/15716 (22) Filing Date: 29/10/2021  
(30) Priority: (73) Owner(s): NOKIA TECHNOLOGIES OY of Karakaari 7, 02610 Espoo, Finland. (72) Inventor(s)  
(74) Agent/Address for service: GALLOWAY & COMPANY, P. O. Box A761, Avondale, Harare, Zimbabwe (54) Title: SCHEDULING REQUEST AND RANDOM ACCESS TRIGGERING FOR SDT (51) Int.Cl.: H 04W 74/08, H 04W 76/30, H 04W 76/27 (57) Abstract: The present discloses a device, method, apparatus and computer readable storage medium of scheduling request (SR) and random access (RA) triggering for small data transmission (SDT). In example embodiments, a terminal device receives, from a network device, a configuration of one or more configured grant (CG) resources for a SDT procedure and a list of one or more data radio bearers (DRBs) associated with respective logical channels (LCHs) allowed for SDT over at least one of the one or more CG resources. After the terminal device initiates the SDT procedure in an inactive mode, if the terminal determines that a buffer status report (BSR) is triggered, the terminal device determines whether a configuration of a SR mask is to be applied for a LCH configured for SDT.

.....  
(11) Patent Number: 8148 date of grant: 13/02/2026  
(21) Application Number: 2024/15790 (22) Filing Date: 20/01/2023  
(30) Priority:20225054 24/01/2022 FI (73) Owner(s): NOKIA TECHNOLOGIES OY of Karakaari 7, 02610 Espoo, Finland.  
(72) Inventor(s)  
(74) Agent/Address for service: GALLOWAY & COMPANY, P. O. Box A761, Avondale, Harare, Zimbabwe  
(54) Title: POWER SAVING IN CELLULAR COMMUNICATION NETWORKS  
(51) Int.Cl.: H 04W 24/02, H 04W 52/02, H 04W 24/10, H 04W 24/08  
(57) Abstract: According to an example aspect of the present disclosure, there is provided an apparatus comprising means for determining that a change of a measurement relaxation status of the apparatus to another measurement relaxation status is triggered, means for determining whether to change the measurement relaxation status to said another measurement relaxation status before a measurement relaxation related event takes place and means for transmitting the report about said another measurement relaxation status to a wireless network node.

.....  
(11) Patent Number: 8139 date of grant: 10/02/2026  
(21) Application Number: 2024/15913 (22) Filing Date: 03/10/2017  
(30) Priority:62/404,302 05/10/2016 US and 62/427,677 29/11/2016 US  
(73) Owner(s): DOLBY LABORATORIES LICENSING CORPORATION of 1275 Market Street San Francisco, California 94103, United States of America.  
(72) Inventor(s)  
(74) Agent/Address for service: SPOOR.FISHER, Total House (2nd Floor), 25 Liberia Road, P.O. Box GP 2319, Accra, Ghana  
(54) Title: SOURCE COLOR VOLUME INFORMATION MESSAGING  
(51) Int.Cl.: H 04N 19/186, H 04N 19/46, H 04N 21/84, H 04N 21/235, H 04N 19/70

(57) Abstract: Methods are described to communicate source color volume information in a coded bitstream using SEI messaging. Such data include at least the minimum, maximum, and average luminance values in the source data plus optional data that may include the color volume

.....  
(11) Patent Number: 8118 date of grant: 13/03/2026  
(21) Application Number: 2024/16078 (22) Filing Date: 15/04/2023  
(30) Priority:202221023511 21/04/2022 IN  
(73) Owner(s): BLUEVERSE HOLDINGS PRIVATE LIMITED of 8th Floor, Regent Chambers, Nariman Point, Mumbai " 400021 Maharashtra 400021 Mumbai, India.  
(72) Inventor(s)  
(74) Agent/Address for service: CronjÃ© & Co., 1 Jan Jonker Road, Klein Windhoek, Windhoek, Namibia  
(54) Title: AN AUTOMATED VEHICLE WASHING SYSTEM AND METHOD THEREOF  
(51) Int.Cl.: B 60S 3/04  
(57) Abstract: Disclosed herein a mobile automated vehicle washing system, wherein, said system comprising a leakage proof enclosure (2), wherein the enclosure (2) comprising first compartment (3) comprising a gantry assembly slidably mounted on a rail guided ceiling (10) of the first compartment (3) for washing, cleansing and drying of the vehicle (V), and second compartment (4) housed with a chemical mixing system (21) and a controller (7) functionally configured to control the gantry assembly (11), chemical mixing system and a water recycling and treatment system (6) connected operably with the enclosure (2) on its exterior surface, wherein the gantry assembly (11) comprises of a plurality of boom sprayers (13) and a coaxial self-rotatable washing mechanism (14) for efficient washing of the vehicle (V). A time efficient method for high quality vehicle washing is also disclosed in this invention.

### 3.0 PATENTS RENEWED UNDER SECTION 61

#### 3.1 National Patents

(11)/(21) 778(KE/P/2008/799) (71) Nokia Technologies Oy (24) Registration/application extended up to: 26/03/2027	(71) TELEFONAKTIEBOLAGET L M ERICSSON (PUBL) (24) Registration/application extended up to: 18/03/2027
..... (11)/(21) 526(KE/P/2009/962) (71) SYNGENTA CROP PROTECTION AG (24) Registration/application extended up to: 19/02/2027	..... (11)/(21) 740(KE/P/2014/2118) (71) GUALA CLOSURES S.P.A. (24) Registration/application extended up to: 26/02/2027
..... (11)/(21) 479(KE/P/2009/963) (71) SELEX COMMUNICATIONS S.P.A. (24) Registration/application extended up to: 12/03/2027	..... (11)/(21) 888(KE/P/2017/2723) (71) TELEFONAKTIEBOLAGET LM ERICSSON (PUBL) (24) Registration/application extended up to: 25/03/2027
..... (11)/(21) 446(KE/P/2010/1130) (71) ISHIHARA SANGYO KAISHA, LTD. (24) Registration/application extended up to: 11/03/2027	..... (11)/(21) 873(KE/P/2018/3011) (71) LOXO ONCOLOGY, INC. (24) Registration/application extended up to: 04/04/2027
..... (11)/(21) 992(KE/P/2010/1149) (71) ISHIHARA SANGYO KAISHA LTD. (24) Registration/application extended up to: 27/03/2027	..... (11)/(21) 928(KE/P/2018/3012) (71) LOXO ONCOLOGY, INC. (24) Registration/application extended up to: 04/04/2027
..... (11)/(21) 992(KE/P/2010/1149) (71) ISHIHARA SANGYO KAISHA LTD. (24) Registration/application extended up to: 27/03/2026	..... (11)/(21) 1051(KE/P/2018/3023) (71) Telesat Canada (24) Registration/application extended up to: 18/04/2027
..... (11)/(21) 704(KE/P/2013/1767)	..... (11)/(21) 1032(KE/P/2019/3076) (71) BANA, Hafeez

(24) Registration/application extended up to:  
18/08/2026  
.....  
(11)/(21) 993(KE/P/2020/3637)  
(71) SAMSUNG ELECTRONICS CO., LTD.  
(24) Registration/application extended up to:  
30/03/2027  
.....  
(11)/(21) (KE/P/2021/3854)  
(71) NOVOZYMES A/S  
(24) Registration/application extended up to:  
20/03/2027  
.....  
(11)/(21) (KE/P/2021/3944)  
(71) NOVOZYMES A/S  
(24) Registration/application extended up to:  
09/05/2026  
.....  
(11)/(21) (KE/P/2021/3944)  
(71) NOVOZYMES A/S  
(24) Registration/application extended up to:  
9/05/2025  
.....  
(11)/(21) (KE/P/2022/4328)  
(71) BAYER AKTIENGESELLSCHAFT  
(24) Registration/application extended up to:  
16/03/2027  
.....  
(11)/(21) 1023(KE/P/2023/4635)  
(71) SAMSUNG ELECTRONICS CO., LIMITED  
(24) Registration/application extended up to:  
30/03/2027  
.....  
(11)/(21) 1022(KE/P/2023/4636)  
(71) SAMSUNG ELECTRONICS CO., LIMITED  
(24) Registration/application extended up to:  
30/03/2027  
.....  
(11)/(21) (KE/P/2023/4671)  
(71) MITSUBISHI HEAVY INDUSTRIES, LTD.  
(24) Registration/application extended up to:  
22/02/2026  
.....  
(11)/(21) (KE/P/2023/4677)  
(71) BAYER AKTIENGESELLSCHAFT  
(24) Registration/application extended up to:  
04/03/2027  
.....  
(11)/(21) (KE/P/2023/4683)  
(71) BAYER AKTIENGESELLSCHAFT  
(24) Registration/application extended up to:  
14/03/2027  
.....  
(11)/(21) (KE/P/2023/4688)  
(71) BIOTICK PESQUISA E DESENVOLVIMENTO  
TECNOLOGICO LTDA.EMPRESA BRASILEIRA DE  
PESQUISA AGROPECUARIA - EMBRAPA  
(24) Registration/application extended up to:  
15/03/2027  
.....

(11)/(21) (KE/P/2023/4693)  
(71) ARDAGH METAL PACKAGING EUROPE GMBH  
(24) Registration/application extended up to:  
21/03/2027  
.....  
(11)/(21) (KE/P/2023/4694)  
(71) ARDAGH METAL PACKAGING EUROPE GMBH  
(24) Registration/application extended up to:  
.....  
(11)/(21) (KE/P/2024/4842)  
(71) AKCIONERNOE OBSHCHESTVO «QUANTUM A  
RUS  
(24) Registration/application extended up to:  
01/03/2027  
.....  
(11)/(21) 1045(KE/P/2024/5091)  
(71) BIOBAB R&D, S.L.  
(24) Registration/application extended up to:  
15/02/2027  
.....  
(11)/(21) (KE/P/2024/5119)  
(71) BAYER AKTIENGESELLSCHAFTSOPRA  
SCIENCES SANTÉ ET HUMAINES S.E.C.  
(24) Registration/application extended up to:  
31/03/2027  
.....  
(11)/(21) (KE/P/2025/5443)  
(71) THE MATERIA COMPANY LIMITED  
(24) Registration/application extended up to:  
07/02/2027  
.....  
(11)/(21) (KE/P/2025/5518)  
(71) TAKAZURI LIMITED  
(24) Registration/application extended up to:  
06/03/2026  
.....  
(11)/(21) (KE/P/2025/5529)  
(71) MYGREEN HOLDING GMBH  
(24) Registration/application extended up to:  
19/03/2027  
.....  
(11)/(21) 1002(KE/P/2020/3611)  
(71) Danieli & C. Officine Meccaniche S.p.A  
(24) Registration/application extended up to:  
27/02/2027  
.....  
(11)/(21) 1014(KE/P/2020/3612)  
(71) SHINING HOPE FOR COMMUNITIES (SHOFKO)  
(24) Registration/application extended up to:  
28/02/2026  
.....  
(11)/(21) 1011(KE/P/2022/4257)  
(71) UNIVERSITY OF JOHANNESBURG  
(24) Registration/application extended up to:  
20/05/2027  
.....  
(11)/(21) (KE/P/2023/4404)  
(71) INTERSWITCH EAST AFRICA (KENYA) LIMITED  
(24) Registration/application extended up to:  
10/02/2027

.....  
(11)/(21) (KE/P/2023/4409)  
(71) GACHAHI ALEX NGUYO  
(24) Registration/application extended up to:  
28/02/2027

.....  
(11)/(21) (KE/P/2024/4896)  
(71) UNIVERSITY OF ELDORETDIVID MASARA  
(24) Registration/application extended up to:  
07/03/2026

.....  
(11)/(21) (KE/P/2025/5229)  
(71) UNIVERSITY OF ELDORETKIBOR DAVID TIROP  
(24) Registration/application extended up to:  
17/03/2027

.....  
(11)/(21) (KE/P/2025/5446)  
(71) Pan African University Institute of Basic  
Science Technology and Innovation (PAUSTI)  
(24) Registration/application extended up to:  
06/08/2027

.....  
(11)/(21) (KE/P/2025/5446)  
(71) Pan African University Institute of Basic  
Science Technology and Innovation (PAUSTI)  
(24) Registration/application extended up to:  
06/08/2028

.....  
(11)/(21) (KE/P/2025/5446)  
(71) Pan African University Institute of Basic  
Science Technology and Innovation (PAUSTI)  
(24) Registration/application extended up to:

.....  
(11)/(21) (KE/P/2025/5807)  
(71) Esther Wairimu Kamau  
(24) Registration/application extended up to:  
08/12/2027

.....

**3.2 NA Change of Owner to Advt**

Application No./Registration No.: AP 7843 Assignor Name & Address: INTERCONTINENTAL ENERGY HOLDINGS GROUP LIMITED, Woodbourne Hall, Po Box 3162, Road Town, Tortola, Virgin Islands (British) [VG]; Assignee Name & Address: INTERCONTINENTAL ENERGY HOLDINGS GROUP LIMITED of Woodbourne Hall, Po Box 3162, Road Town, Tortola, Virgin Islands (British), Brt. Virgin Islands

Application No./Registration No.: U 594 Assignor Name & Address: ALISTOR GOVEDI MALOVA P. O.BOX 7273-40100 Assignee Name & Address: LOCKSTATE LIMITED of P. O. BOX 7273-40100, Kenya

**3.3 NA Change of Owner**

**4.0 UTILITY MODEL APPLICATIONS PUBLISHED UNDER SECTION 42 AND REGULATION 35**

**4.1 National Application**

(21) KE/U/2025/3016 (22) 05/06/2025 (30) Priority: (73) PAULINE KAROBIA of P.O BOX 75 -10200 KENYA , Kenya; Dr. Peter Waithaka of P.O BOX 75 - 10200 KENYA, Kenya and Professor Eng. Chritopher Maina of P.O BOX 75 - 10200 KENYA , Kenya (72) P. WAITHAKA; PAULINE KAROBIA and C.MURIITHI (74) (54) SOLAR POWERED SAND SCREENING MACHINE (51) B 07B 1/34(2006.01) (57) A solar powered sand screening machine comprising a solar panel, a power storage unit, and a support frame (1). A sieve tray (2) is mounted on the support frame (1). A DC motor (3), powered by the solar panel and storage unit, drives a rotary disc (4). A connecting arm (5) links the rotary disc (4) to the sieve tray (2). The connecting arm (5) converts the rotary motion from the motor into an oscillatory motion of the sieve tray (2), causing sand particles placed thereon to be separated by size

(21) KE/U/2025/3017 (22) 05/06/2025 (30) Priority: (73) THREESTAR HOMEX LIMITED of P.O BOX 17730-00500, NAIROBI, Kenya (72) LUTAO (74) (54) COMBINED BOTTLE FOR PACKAGING (51) B 65D 81/32(2006.01) // (B 65D 81:32 ) (57)

(21) KE/U/2025/3433 (22) 16/10/2025 (30) Priority: (73) CHRIS MURAGUI of 466 RUARAKA, Kenya (72) (74) (54) TITRATABLE NON-AQUEOUS CATHA EDULIS EXTRACT FORMULATION FOR ADMINISTRATION VIA INHALATION (51) A 61M 15/00(2006.01) (57) A non-aqueous acceptable formulation of Catha edulis in a mixture of propylene glycol and glycerin, designed for use in electronic vaporization or inhalation delivery devices. The composition maintains the chemical stability and potency of Catha edulis alkaloids and it 130 represents a modern and portable alternative to traditional Catha edulis consumption methods.

(21) KE/U/2025/3460 (22) 12/11/2025 (30) Priority: (73) GODFREY GICHACHI WAHOME of P. O. BOX 72286-00200, Kenya; ALEXANDER GADIEL MWAREMA of P. O. BOX 72286-00200, Kenya and SAMUEL MUNYIRI GIATU of P. O. BOX 72286-00200, Kenya (72) GODFREY GICHACHI WAHOME and ALEXANDER GADIEL MWAREMA (74) (54) SYSTEM AND METHOD FOR OTP-CONTROLLED MOBILE ESCROW TRANSACTIONS VIA USSD, PAYBILL, TILL NUMBER , SEND MONEY (51) G 06Q 20/02(2012.01) (57) The present invention relates to a system and method for executing mobile money escrow transactions controlled by one-time passwords (OTPs) via USSD, paybill, till number, and send- money channels. The system enables a payer to initiate an escrow transaction, temporarily hold funds in a secure escrow account, and generate transaction-specific OTPs tied to unique transaction identifiers and escrow states. OTPs are transmitted to the transacting parties via USSD, SMS, or mobile money notifications and are used to .authorize changes in escrow state, including deposit, hold, release, cancellation, and dispute resolution. The escrow module releases or returns funds only upon successful OTP verification. The invention provides secure, conditional, and auditable transactions entirely within existing mobile money infrastructures, without requiring internet access or smartphones, thereby reducing fraud risk, enhancing trust, and ensuring accessibility for all users .

(21) KE/U/2025/3461 (22) 12/11/2025 (30) Priority: (73) LEAH WANJA MATI of P. O. BOX 30701-00100

NAIROBI, Kenya (72) LEAH WANJA MATI (74) (54) AN EDUCATIONAL CARD GAME FOR LEGAL KNOWLEDGE ENHANCEMENT (51) A 63F 1/00(2006.01) (57) An educational card game system for enhancing legal knowledge, comprising a physical deck of cards organized into multiple color-coded clusters, each representing a specific legal category. The system includes six distinct clusters containing twenty-five cards each, with every card featuring a legal question on one face and its corresponding answer on the opposite face. Each cluster maintains a unique color scheme for immediate visual identification and cognitive association between colors and legal domains. The game employs a structured question-and-answer format covering fundamental legal principles, case precedents, statutory provisions, and procedural rules within a specific jurisdiction. The color-coded clustering system enables both focused study within specific legal domains and comprehensive testing across multiple legal genres. Visual differentiation through distinct coloring facilitates rapid sorting, organization, and retrieval of cards during gameplay. Multiple gameplay configurations support various educational settings, including individual study, group competition, and formal classroom environments. The system accommodates a designated card reader, multiple player stations, and an integrated common display for larger audience participation. Game modes include cluster-specific learning, mixed-cluster testing, team challenges, and progressive difficulty levels. Designed specifically for Kenyan legal education, the invention provides an accessible, tactile learning tool that bridges professional legal training and public legal awareness. The physical, non-digital format ensures deployment without electricity or internet connectivity, making it suitable for resource-limited environments. The system transforms complex legal concepts into engaging interactive content while maintaining structural rigor and jurisdictional specificity. Manufactured using conventional card production technology, the game represents an innovative approach to legal pedagogy that combines organized knowledge presentation, interactive learning methodology, and scalable implementation frameworks for diverse educational contexts.

.....  
 (21)\_KE/U/2025/3484 (22) 01/12/2025 (30) Priority: (73) DUNCAN ARIMI of GRAVITY CBC LIMITED P.O BOX 7077-00100 NAIROBI KENYA , Kenya (72) (74) (54) INTERACTIVE MAGNETIC EDUCATIONAL MODEL OF THE HUMAN RESPIRATORY SYSTEM (51) G 09B 23/30(2006.01), G 09B 23/28(2006.01) (57) An interactive educational model for demonstrating the human respiratory system comprising a base structure representing a human torso with magnetised attachment regions corresponding to respiratory organs, and detachable metalised name tags bearing indicia of respective organs. During instruction, learners identify and attach the tags to the corresponding magnetised regions, promoting tactile and collaborative engagement. The model enables experiential, learner-centred understanding of anatomical relationships and may include optional accessibility features such as Braille labeling, colour coding, and visual or audible feedback. It is simple to manufacture, durable, and suitable for repeated educational use.

.....  
 (21)\_KE/U/2025/3485 (22) 01/12/2025 (30) Priority: (73) DUNCAN ARIMI of GRAVITY CBC LIMITED P.O BOX 7077-00100 NAIROBI KENYA , Kenya (72) (74) (54) MALE REPRODUCTIVE SYSTEM LEARNING MODEL (51) G 09B 23/30(2006.01), G 09B 23/28(2006.01) (57) Disclosed is an educational model designed to enhance the teaching and learning of the structure of the human male reproductive system. The apparatus comprises a supporting base on which are mounted molded anatomical representations of the major male reproductive organs. Each anatomical representation is uniquely fitted with an embedded magnetic element for the secure, but detachable, attachment of corresponding magnetic name tags bearing anatomical identifiers. Learners utilize the model to actively identify and label each organ and subsequently describe its function, promoting a highly interactive, visual, and tactile learning experience for effective anatomical study

.....  
 (21)\_KE/U/2025/3486 (22) 01/12/2025 (30) Priority: (73) DUNCAN ARIMI of GRAVITY CBC LIMITED P.O BOX 7077-00100 NAIROBI KENYA , Kenya (72) (74) (54) MAGNETIZED MODEL AND BLOOD VESSEL LEARNING KIT (51) G 09B 23/28(2006.01) (57) A magnetized educational model and learning kit for teaching the structure and characteristics of blood vessels. The model includes a base supporting molded vessel elements representing arteries veins and capillaries arranged to demonstrate their interconnections. Each vessel element includes magnetized regions for attachment of removable magnetic label tokens bearing vessel identifiers enabling learners to identify and label vessels interactively. Visual and tactile cues distinguish vessel types and accompanying instructional materials support guided learning and assessment. The invention provides a reusable hands-on teaching aid that enhances understanding of circulatory anatomy through active participation.

.....  
 (21)\_KE/U/2025/3487 (22) 01/12/2025 (30) Priority: (73) DUNCAN ARIMI of GRAVITY CBC LIMITED P.O BOX 7077-00100 NAIROBI KENYA , Kenya (72) (74) (54) MAGNETIC INTERACTIVE MODEL OF THE HUMAN DIGESTIVE SYSTEM (51) G 09B 23/28(2006.01) (57) A magnetic interactive educational model of the human digestive system is disclosed. The model comprises a base structure representing the human torso and provided with

magnetized regions corresponding to principal digestive organs including the mouth, oesophagus, stomach, duodenum, liver, gall bladder, pancreas, small intestine, large intestine, rectum, anus, and appendix. A plurality of detachable metalized name tags bearing the names of the respective organs are configured to magnetically attach to the corresponding regions on the base structure. During use, learners identify and place the name tags onto the appropriate anatomical locations, thereby enabling interactive and participatory learning of digestive system anatomy. The base structure may be fabricated from wood, plastic, or composite material and may be configured for wall mounting or stand placement. Optional features such as colour coding, tactile markings including Braille, LED indicators, or audible feedback may be incorporated to enhance accessibility and instructional effectiveness. The model provides a durable, reusable, and low-cost teaching aid that promotes active engagement and improved understanding of human digestive anatomy.

.....  
 (21) KE/U/2025/3488 (22) 01/12/2025 (30) Priority: (73) DUNCAN ARIMI of GRAVITY CBC LIMITED P.O BOX 7077-00100 NAIROBI KENYA , Kenya (72) (74) (54) A LEARNING MODEL APPARATUS FOR TEACHING THE FEMALE REPRODUCTIVE SYSTEM (51) G 09B 23/30(2006.01) (57) An interactive anatomical learning apparatus is disclosed, comprising a three-dimensional model of the female reproductive system and a set of removable, magnetisable name tags. The model is engineered with concealed magnetised or ferromagnetic-receiving regions positioned at critical anatomical structures, specifically including the ovary, ovum, fallopian tubes, uterus, cervix, birth canal, and uterine wall. Each name tag bears the printed name of one of these anatomical structures and is configured for secure, reversible attachment to the corresponding region by magnetic coupling. This apparatus facilitates interactive identification and repeated practice, providing a superior, tactile, and visually reinforced method for acquiring and assessing knowledge of an anatomical structures.

.....  
 (21) KE/U/2026/3539 (22) 12/02/2026 (30) Priority: (73) Robert Mwendwa Mackenzie of Kinanie road , Gimu Estate, 00507, Nairobi, Kenya (72) Robert Mwendwa Mackenzie (74) Grace Wanjiru Ngandah Kinanie Road, Gimu Estate 00507 Nairobi (54) method for processing avocado oil residues into stabilised solid bio-fuels and products thereof. (51) C 11B 3/00(2006.01) // (C 11B 3:00 ) (57) A method for the conversion of high-moisture avocado oil processing residues into stabilized, industrial-grade solid biofuels. The invention involves a stabilization process that reduces the moisture content of avocado pits, skins, and pulp to a level sufficient to inhibit microbial decomposition and enzymatic oxidation. The resulting desiccated material is processed into various physical formats-including loose sludge, pulverized powder, chunks, and densified pellets or briquettes-tailored for specific industrial combustion systems. These formats allow for the direct or co-fired replacement of fossil fuels in high-heat applications such as cement kilns, ceramic factories, and industrial boilers. The invention simultaneously addresses the environmental challenges of organic waste disposal while providing a renewable, high-calorific energy source for local industries.

.....  
 (21) KE/U/2026/3541 (22) 16/02/2026 (30) Priority: (73) EURO SILAGE MASTER LTD of P.O. BOX 1473-00600 NAIROBI, Kenya (72) STARLEY KIRIMI (74) (54) ANTI-RODENT POLYTHENE BAG AND MANUFACTURING PROCESS THEREOF (51) A 01N 25/34(2006.01) (57) An anti-rodent polythene bag and a method of manufacturing the same are disclosed. The bag is formed from a polyethylene film comprising a blend of linear low density polyethylene and low density polyethylene and includes a non-toxic rodent repellent masterbatch uniformly dispersed within the polymer matrix. The rodent repellent masterbatch comprises a bitter taste agent, including denatonium benzoate. The polyethylene film is produced by a blown film extrusion process in which the masterbatch is incorporated during extrusion at a temperature range of approximately 160°C to 220°C, followed by cooling, winding, cutting, and sealing to form individual bags.

.....  
 (21) KE/U/2026/3547 (22) 26/02/2026 (30) Priority: KE/P/2025/5828 18/12/2025 KE (73) Ngura Erastus Odhiambo of P. O. BOX 7741-00100 NAIROBI, 0100, Nairobi , Kenya and Ngura Marsha Akoth of P. O. BOX 7741-00100 NAIROBI, 00100, Nairobi , Kenya (72) Ngura Erastus Odhiambo and Ngura Marsha Akoth (74) (54) DISTRIBUTED COMPUTING SYSTEM FOR GEOGRAPHIC DATA BASED REQUEST ROUTING AND WEIGHTED AUTHORIZATION (51) G 06F 21/62(2013.01), G 06F 15/16(2006.01) (57) A distributed computing system comprising one or more processors and memory configured to receive digitally generated requests associated with geographic location data, to identify a subset of registered user devices within a defined geographic boundary based on proximity calculations, and to control processing of the requests using a weighted authorization mechanism. The system includes a location processing module configured to determine geographic proximity using stored location parameters, an activity analysis module configured to compute authorization weights based on recorded user interaction metrics, and a control module configured to permit or restrict request execution based on aggregated authorization outcomes. The system further includes a prioritization module configured to classify requests based on predefined urgency parameters and to allocate system resources accordingly. Transaction execution is performed through a secure processing interface, and

system state data is stored in a distributed data repository. The system operates within defined territorial constraints and provides automated request routing, authorization, prioritization, and execution based on geographic and activity based data parameters.

.....  
(21) KE/U/2026/3552 (22) 06/03/2026 (30) Priority: (73) Bradley Mbagaya of P.O Box 30851-00100, Kirigiti, Kiambu, Kenya (72) Bradley Mbagaya (74) (54) Modular Hydroponic Cultivation Unit Utilizing a Standardized Plastic Crate Base and Matrix Growth Interface (51) A 01G 31/02(2006.01), A 01G 31/06(2006.01), A 01G 9/02(2018.01), B 65D 21/02(2006.01) (57) A modular hydroponic cultivation unit comprising a plastic crate defining a nutrient solution reservoir and a detachable matrix tray positioned on an upper rim of the crate. The matrix tray comprises a plurality of apertures configured to receive plant holding containers. The matrix tray is dimensioned to correspond to the crate opening and forms an interface with the crate to maintain alignment during use. The crate and matrix assembly define a plant support structure positioned above the nutrient reservoir.

.....  
**4.2 Utility Model Granted**

**5.0 UTILITY MODELS REGISTERED**

**5.1 National Utility Models**

**5.2 ARIPO UTILITY MODEL REGISTERED**

**6.0 UTILITY MODELS RENEWED**

(11)/(21) (KE/U/2022/1973)  
(71) DEDAN KIMATHI UNIVERSITY OF TECHNOLOGY  
(24) Registration/application extended up to: 07/11/2027  
.....

**6.1 Utility Model Issue Certificate**

(11) Registration no.: 612 (45) Date of grant: 12/03/2026 (21) Application no.: KE/23/02305 (22) Filing Date: 19/10/2023 (31) Priority: (73) Applicant(s): ENOW SADDAM NOORABDIKADIR ABDULBARIAMAL MOHAMED ABDIKADIR P.O. BOX 40629-00100 NAIROBI, Kenya; P.O. BOX 40629-00100 NAIROBI, Kenya and P.O. BOX 40629-00100 NAIROBI, Kenya (72) Inventors: ENOW SADDAM NOOR (74) Agent: , P.O. BOX 40629-00100 NAIROBI (51) Int.Cl.2018.01: H 04L 9/32(2006.01), H 04W 12/06(2009.01), G 06F 21/32(2013.01), G 06Q 20/00(2012.01), G 06Q 40/00(2012.01) (54) Title: ADVANCED MOBILE BANKING (57) External transfers, enables account holders of mobile banking i.e. m- pesa to access their accounts without necessarily having their phones. This can be achieved in three ways; (1) It enables the account holders to access their account through someone else's phone, (2) It enables account holders to access their accounts through a programmed telephony, (3) It enables the account holders to use a visa card to access their accounts.

.....  
(11) Registration no.: 613 (45) Date of grant: 13/03/2026 (21) Application no.: KE/24/02812 (22) Filing Date: 04/11/2024 (31) Priority: (73) Applicant(s): KAHSAW WOLDAY BARNABAS GREEN WOOD DRIVE-NYALI P. O. BOX 41037-80100 MOMBASA, Kenya (72) Inventors: KAHSAW WOLDAY BARNABAS (74) Agent: , GREEN WOOD DRIVE-NYALI P. O. BOX 41037-80100 MOMBASA (51) Int.Cl.2018.01: C 04B 7/36(2006.01) (54) Title: EPS CEMENT SANDWICH PANEL MANUFACTURING PROCESS (57) The invention discloses a manufacturing process for EPS Cement Sandwich Panels that improves structural durability, insulation performance, and production efficiency. The process involves embedding an EPS foam core between high-strength cement skins, reinforced with fiberglass mesh for added tensile strength. Controlled curing and bonding agents are used to ensure strong adhesion between layers, resulting in a lightweight, thermally efficient panel ideal for load-bearing and insulation applications.

.....  
(11) Registration no.: 617 (45) Date of grant: 23/03/2026 (21) Application no.: KE/25/02855 (22) Filing Date: 23/01/2025 (31) Priority: KE/UM/2024/2844 17/12/2024 KE (73) Applicant(s): CENTER FOR MATERNAL HEALTH INNOVATIONS LTD (CMHI) P.O BOX 6805-40103 KISUMU, Kenya (72) Inventors: MONICA OGUTU (74) Agent: ONC LAW PARTNERS, 37592-00100 NAIROBI (51) Int.Cl.2018.01: A 61F 17/00(2006.01), A 61P 7/04(2006.01) (54) Title: POSTPARTUM HEMORRHAGE (PPH) CARE BUNDLE KIT FOR EMERGENCY MANAGEMENT AND PREVENTION.(57) Postpartum Hemorrhage (PPH) Care Bundle Kit for Emergency Management and Prevention The present invention discloses a care bundle kit for emergency management and prevention of postpartum hemorrhage (PPH). It provides a care bundle for the emergency management and prevention of postpartum hemorrhage (PPH) after childbirth. It describes a comprehensive, integrated system that includes pharmaceutical components, medical devices, and diagnostic tools, as well as educational training materials, all designed to systematize and streamline emergency obstetric care for the management of PPH. It comprises a first response bundle including pre-dosed pharmaceutical components comprising oxytocin, misoprostol, and tranexamic acid; medical devices comprising uterine balloon tamponade, foley catheter with drainage bag, and non-pneumatic anti-shock garment;a refractory response bundle comprising additional interventions for severe cases, including compression, blood transfusion, and transportation to a higher facility, and a modular packaging system with organized compartments for easy access to each component.

.....  
(11) Registration no.: 611 (45) Date of grant: 12/03/2026 (21) Application no.: KE/25/03080 (22) Filing Date: 18/07/2025 (31) Priority: (73) Applicant(s): FUGA EQUIPMENT AND MACHINERY P.O BOX 32544-00600 NAIROBI , Kenya (72) Inventors: PAUL KAMAU MAINA (74) Agent: GRACE MUTHONI ADVOCATES, P.O BOX 568-00623 NAIROBI (51) Int.Cl.2018.01: A 01K 41/00(2006.01) (54) Title: EGG INCUBATOR (57) An egg incubator comprising an enclosed incubation chamber, a heating system, a humidity regulation system, and a tray support structure. The incubator includes an access door inclined at an angle of 25° to 35° relative to a vertical axis to enable controlled handling of egg trays. The humidity regulation system maintains internal relative humidity between 45% and 65%, adjustable in ±3% relative humidity increments, thereby providing stable and repeatable incubation conditions suitable for poultry egg development

.....  
(11) Registration no.: 615 (45) Date of grant: 13/03/2026 (21) Application no.: KE/25/03082 (22) Filing Date: 22/07/2025 (31) Priority: (73) Applicant(s): AUGUSTINE MUTHOMI P. O. BOX 7829-01000, Kenya (72) Inventors: AUGUSTINE MUTHOMI (74) Agent: , P. O. BOX 7829-01000 (51) Int.Cl.2018.01: F 23G 7/05(2006.01) (54) Title: System and Method for Small Scale Waste Engine Oil Purification(57) A small-scale system and method for purifying waste engine oil by pre-settling and filtering solids, heating to evaporate water, and treating with adsorbents such as bentonite clay and activated carbon to remove dissolved impurities. The spent adsorbents are separated using filtration or centrifugation. The process yields clarified oil suitable for reuse and is designed for affordable local implementation without pyrolysis or hazardous acid treatments

.....  
(11) Registration no.: 616 (45) Date of grant: 13/03/2026 (21) Application no.: KE/25/03101 (22) Filing Date: 01/09/2025 (31) Priority: (73) Applicant(s): EAGO GROUP AUTOMATIONS LTD 17465-00100 NAIROBI, Kenya (72) Inventors: CAROLINE WAITHIRA NJOROGE; LENNY WEDA and BENSON MUEHEMI WARUTUMO (74) Agent: , 17465-00100 NAIROBI (51) Int.Cl.2018.01: G 05B 19/42(2006.01), G 06F 15/16(2006.01), G 06Q 20/00(2012.01), A 63D 15/06(2006.01), A 63D 15/00(2006.01) (54) Title: CASHLESS PAYMENT INTERGRATIONS INTO A MOTORIZED DIGITAL POOL-TABLE MANAGEMENT SYSTEM (57) Cashless Payment Integrations into a Motorized Digital Pool-Table Management System entails integration of cashless mobile payments(Mpesa) and monitoring of related data through a centralized pool table management system. The integrations depend on customized circuitry for receiving, processing and transmitting data to server and to actuator and display of appropriate data by involved parties. The mechanical structure comprises of the feeding channel assembly 15 that feeds ball into Main channel assembly 17 which is pivotally connected to the motor so as to be capable of tilting. The Top Sensor on Top Sensor carrier 18 vertically aligned to bottom sensor attached on balls exit channel 19, senses ball count to determine when a game is complete. Tray front plate 16 and Tray back plate 20 supports the assemblies and gives mounting provision of the tray for screwing to the pool table

.....  
(11) Registration no.: 614 (45) Date of grant: 13/03/2026 (21) Application no.: KE/25/03108 (22) Filing Date: 11/09/2025 (31) Priority: (73) Applicant(s): VICTORIA NYAMBURA MWAURADAVID MWAURA 1332-00902 KIKUYU, Kenya and 1332-00902 KIKUYU , Kenya (72) Inventors: (74) Agent: BRIAN OKEBIRO, 1332-00902 KIKUYU (51) Int.Cl.2018.01: G 02C 11/08(2006.01), G 09B 21/00(2006.01), G 10L 25/00(2013.01) (54) Title: SMART GLASSES WITH MONOCULAR CAMERA AND AUDIO FEEDBACK SYSTEM (57) The invention relates to smart glasses comprising a spectacle frame, a monocular camera, a processing module, and an audio

feedback system. The monocular camera captures images of the environment, and the processing module applies artificial intelligence algorithms to generate spatial and descriptive information from two-dimensional input. The audio feedback system provides this information to the user through bone-conduction or in-ear speakers. The glasses further comprise a microphone for voice-command input, optional haptic feedback modules, wireless communication components, and a rechargeable power supply optionally supplemented with solar panels. The invention falls within the field of wearable assistive devices and is principally used for providing visually impaired persons with environmental awareness, object identification, and navigation support.

.....

### 7.0 INDUSTRIAL DESIGN APPLICATIONS PUBLISHED UNDER SECTION 87 AND REGULATION 48

NOTICE is given that any person who has grounds of opposition to the Registration of any of the Industrial designs published herein may within sixty (60) days from the date of this Journal, lodge a notice of opposition on form IP 36 (in duplicate) together with a fee of Ksh.5,000/= (local opponent) or US\$ 250 (foreign opponent).

The period of lodging the notice of opposition may be extended by the Managing Director as he deems fit and upon such terms as he may direct. Any request for such extension should be made to the Managing Director to reach him before the expiry of the period allowed.

Formal opposition should not be lodged until after reasonable notice has been given in writing to the applicant to afford him an opportunity of withdrawing his application before the expense of preparing the notice of opposition is incurred. Failure to give such notice will be taken into account in considering any application by an opponent for an order for costs if the opposition is uncontested by the applicant. Representations and samples of the designs advertised herein can be seen at the Patent Registry, Kenya Industrial Property Institute, KIPi Centre, 17 Kabarsiran Avenue, Off Waiyaki Way, Lavington, Nairobi.

#### 7.1 National Applications

(21):2024/2949 (22): 27/05/2024 (30):015042970-0001 01/12/2023 EM (73): VERSUNI HOLDING B.V. HIGH TECH CAMPUS 42 5656AE EINDHOVEN, The Netherlands (74): Hamilton Harrison & Mathews Advocates, P. O. Box 30333-00100, Nairobi (51) International Class (Loc (6)): 07-05 (54): HAND-HELD STEAMERS The features of the design for which novelty is claimed are the shape and the configuration of the article as shown in the representation.

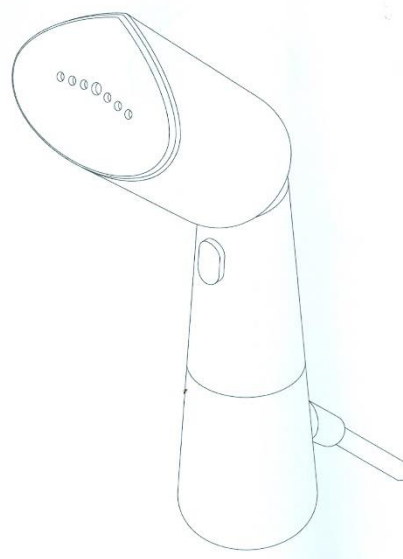

.....

(21):2025/3450 (22): 24/07/2025 (30):6419309 24/01/2025 UK (73): Tangle Teezer Limited of Union House

182-194, Union Street, London SE1 0LH, United Kingdom (74): Hamilton Harrison & Mathews Advocates, P. O. Box 30333 -00100, Nairobi (51) International Class (Loc (6)): 04-02 (54): HAIR BRUSH The features of the design for which novelty is claimed are the shape and the configuration of the articles as shown in the representation.

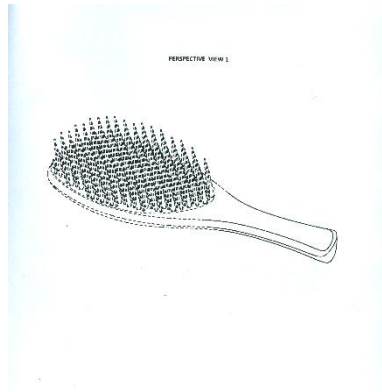

(21):2025/3451 (22): 24/07/2025 (30):6419285 24/01/2025 UK (73): Tangle Teezer Limited of Union House 182-194, Union Street, London SE1 0LH, United Kingdom (74): Hamilton Harrison & Mathews Advocates, P. O. Box 30333 -00100, Nairobi (51) International Class (Loc (6)): 04-02 (54): HAIR BRUSH The features of the design for which novelty is claimed are the shape and the configuration of the articles as shown in the representation.

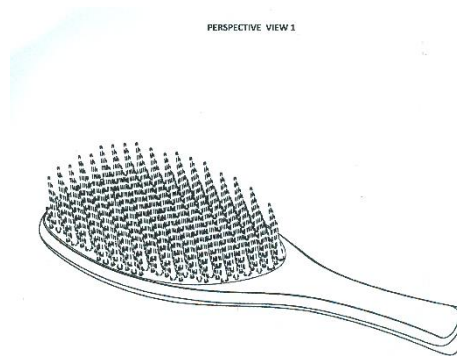

(21):2025/3488 (22): 26/08/2025 (30):None (73): SOLARKY MOBILITY TECHNOLOGIES CO., LTD. of ROOM 1111, BLOCK A, LONGGUANG JIUZUAN NORTH PHASE A, HONGSHAN COMMUNITY, MINZHI STREET, LONGHUA DISTRICT, SHENZHEN 518110, CHINA, China (74): Hamilton Harrison & Mathews Advocates, P. O. Box 30333 -00100, Nairobi (51) International Class (Loc (6)): 12-08 (54): PHOTOVOLTAIC ELECTRIC VEHICLE The features of the design for which novelty is claimed are the shape and the configuration of the article as shown in the representation



(21):2025/3515 (22): 14/11/2025 (30):None (73): ROAM ELECTRIC AB P. O. BOX 5325, 10247 Stockholm, Sweden (74): PERPETUA N LAW ADVOCATES T/A VON SEIDELS KENYA, P. O. BOX 785-00618 NAIROBI (51) International Class (Loc (6)): 13-02 (54): BATTERY HOUSING Thenovelty of the designs is in the shape and configuration of battery housing as illustrated in the accompanying renderings. Colour forms no part of the

design and is disclaimed.



Figure 1: Front View

## 7.2 Corrigenda

(21):2022/2561 (22): 25/02/2022 (30):29/806,156 01/09/2021 US(73): Thermos L.L.C Of 475 N. Martingale Road, Suite 1100, Schaumburg, IL 60173 , U.S.A. (74): Coulson Harney LLP, P. O. Box 10643, 00100, Nairobi(51) International Class (Loc (6)): 09-01 (54): DECORATION FOR CONTAINER The ornamental design for a beverage container.

1/17

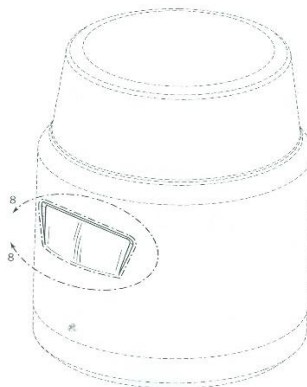

FIG. 1

(11): KE 1065 (45): 18/08/2025 (21):2023/4669 (22):24/02/2022 (30):2021-027987 24/02/2021 JP (73): JAPAN METALS AND CHEMICALS CO., LTD. of Third Floor, Higashi-kayaba-cho Yuraku Bldg., 17-25, Shinkawa 1-chome, Chuo-ku, Tokyo1048257 , Japan (72): HISHI Yasuyuki; KAWAKAMI Noriaki; IKEI Anzu and HIRAYAMA Shunichi (74): Hamilton Harrison & Mathews Advocates P. O. Box 30333-00100, Nairobi(54): METHOD FOR REMOVING SCALE FROM GEOTHERMAL TURBINE BLADE AND METHOD FOR GEOTHERMAL POWER GENERATION(51) Int.Cl.: F 01D 25/00(2006.01), F 01K 25/00(2006.01), F 01K 9/00(2006.01), F 03G 4/00(2006.01)// (F 01D 25:00, F 01K 25:00, 9:00, F 03G 4:00 ) (57): Provided is a method for removing scale from turbine blades in a geothermal power generation system. The present method for removing scale from turbine blades is characterized in that an alkaline solution and a chelating solution are injected into geothermal steam that flows into a turbine during power generation, and geothermal scale formed on and adhered to turbine blades is removed by the injected solutions. The present removal method has improved scale removal effectiveness over conventional methods and makes it possible, in a short amount of time, scale adhering to geothermal turbine blades. The present invention also makes it possible to provide a method for geothermal power generation in which scale is prevented from adhering to turbine blades, and a

geothermal power generation system capable of operating continuously without performing cleaning in which a turbine is opened, even when geothermal steam containing 0.1ppm or more SiCO<sub>2</sub> and/or C1 is introduced into the turbine.

.....

### 7.3 Registered Industrial Designs

(11): 2111 (45): 12/03/2026 (21): 2025/3401 (22): 26/05/2025 (30): (51): (Loc (6)):09-01 (54): BOTTLE (73): NEWCENT INDUSTRIES LIMITED 19182-00100 NAIROBI, Kenya (74): ,The novelty of the design is in the shape,configuration and ornamentation of the BOTTLE as shown in therepresentation



.....

(11): 2112 (45): 12/03/2026 (21): 2024/3214 (22): 07/11/2024 (30): (51): (Loc (6)):09-04 (54): FOLDABLE PLASTIC CRATE (73): KENPOLY MANUFACTURERS LIMITED P.O. BOX 30032-00100 NAIROBI, Kenya (74): ,The features for the design for which novelty is claimed is the shape and configuration of the design entitled plastic foldable crate with interlocking , perforated stripes in all sides and re-inforced 4 edges at the bottom and one in the centre making it unique.



.....

(11): 2113 (45): 13/03/2026 (21): 2025/3261 (22): 19/02/2025 (30): (51): (Loc (6)):09-01 (54): SPRAY BOTTLE (73): ALICTON LTD P.O. BOX 9244-00100 NAIROBI KENYA, Kenya (74): ,The NOVELTY of the design resides in the shape,pattern ,ornamentation and features of the SPRAY BOTTLE thereof as shown in the aesthetic features and representation. I disclaim all the wordings,image of an ear and icons on the design

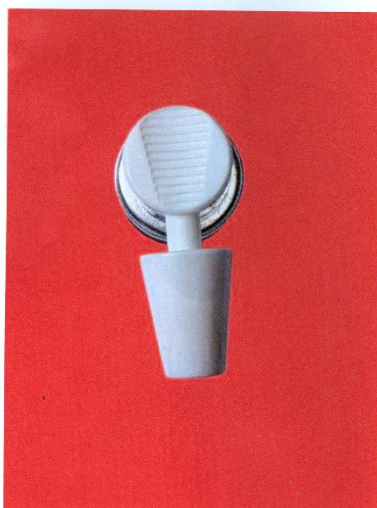

.....  
(11): 2114 (45): 13/03/2026 (21): 2025/3403 (22): 05/06/2025 (30): (51): (Loc (6)):09-01 (54): BOTTLE (73): THREESTAR HOMEX LIMITED P.O BOX 17730-00500, NAIROBI, Kenya (74): ,The features of the design for which novelty is claimed are the shape, configuration, ornamentation and pattern as shown in the representation attached to the industrial design application for the BOTTLE.

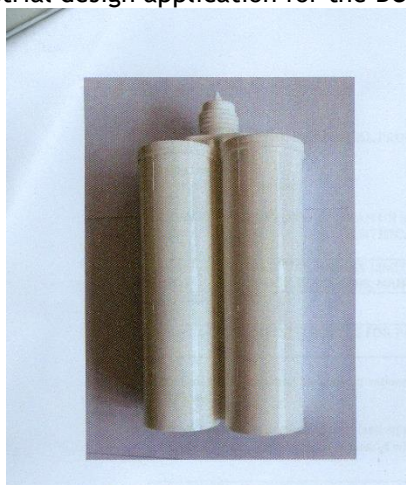

.....  
(11): 2115 (45): 19/03/2026 (21): 2025/3390 (22): 15/05/2025 (30): (51): (Loc (6)):23-01 (54): HAND SHOWER (73): NASIB PAINTS AND HARDWARE LTD P. O. BOX 32745-00600 NAIROBI, Kenya (74): , The features for which novelty is claimed are the features of shape, configuration and ornamentation of the article as shown in the graphic representations.

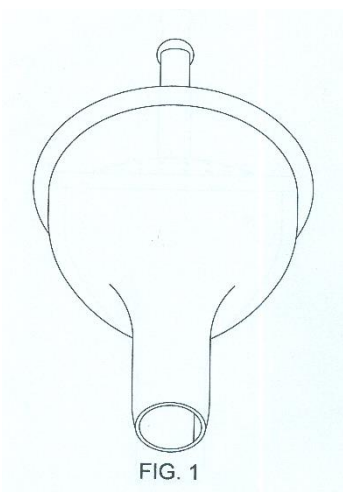

.....

(11): 2116 (45): 19/03/2026 (21): 2025/3394 (22): 15/05/2025 (30): (51): (Loc (6)):13-03 (54): CONTACT CLIPS (73): NASIB PAINTS AND HARDWARE LTD P. O. BOX 32745-00600 NAIROBI, Kenya (74): ,The features for which novelty is claimed are the features of shape, configuration and ornamentation of the article as shown in the graphic representations.

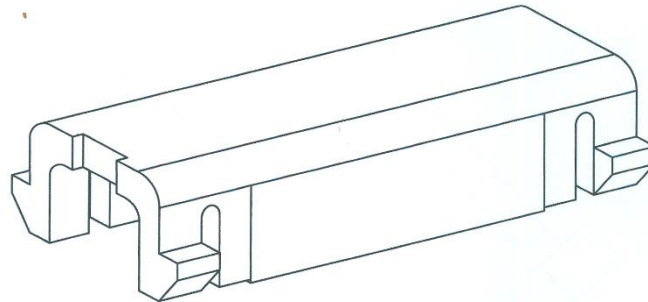

FIG. 1

.....  
(11): 2117 (45): 19/03/2026 (21): 2025/3395 (22): 15/05/2025 (30): (51): (Loc (6)):13-02 and 23-03 (54): HEATING ELEMENT (73): NASIB PAINTS AND HARDWARE LTD P. O. BOX 32745-00600 NAIROBI, Kenya (74): ,The features for which novelty is claimed are the features of shape, configuration and ornamentation of the article as shown in the graphic representations.

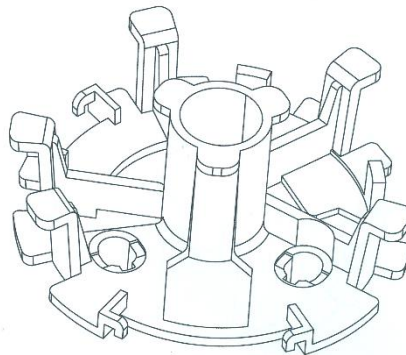

FIG. 1

.....  
(11): 2118 (45): 19/03/2026 (21): 2025/3391 (22): 15/05/2025 (30): (51): (Loc (6)):13-03 (54): ELECTRICAL CONTACT (73): NASIB PAINTS AND HARDWARE LTD P. O. BOX 32745-00600 NAIROBI, Kenya (74): ,The features for which novelty is claimed are the features of shape, configuration and ornamentation of the article as shown in the graphic representations.



FIG. 2

.....  
(11): 2119 (45): 19/03/2026 (21): 2025/3392 (22): 15/05/2025 (30): (51): (Loc (6)):13-03 (54): ELECTRICAL CONTACT (73): NASIB PAINTS AND HARDWARE LTD P. O. BOX 32745-00600 NAIROBI, Kenya (74): ,The features for which novelty is claimed are the features of shape, configuration and ornamentation of the article as shown in the graphic representations.

1/3

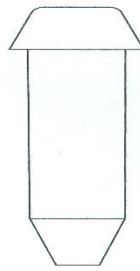

FIG. 2

.....  
(11): 2120 (45): 19/03/2026 (21): 2025/3393 (22): 15/05/2025 (30): (51): (Loc (6)):23-03 (54): HEATING CHAMBER (73): NASIB PAINTS AND HARDWARE LTD P. O. BOX 32745-00600 NAIROBI, Kenya (74): ,The features for which novelty is claimed are the features of shape, configuration and ornamentation of the article as shown in the graphic representations.

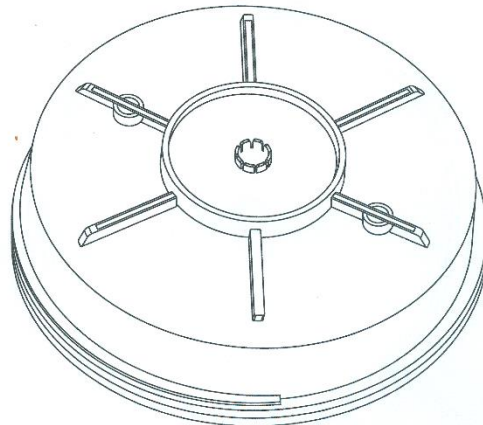

FIG. 1

.....  
(11): 2121 (45): 23/03/2026 (21): 2025/3389 (22): 15/05/2025 (30): (51): (Loc (6)):23-01 (54): SHOWER ARM (73): NASIB PAINTS AND HARDWARE LTD P. O. BOX 32745-00600 NAIROBI, Kenya (74): ,The features for which novelty is claimed are the features of shape, configuration and ornamentation of the article as shown in the graphic representations.

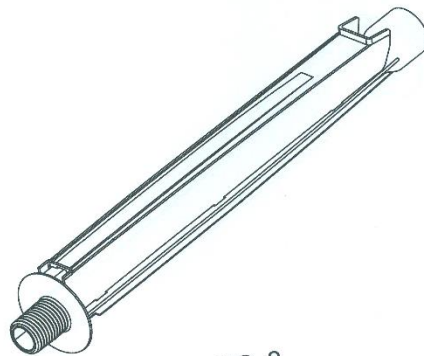
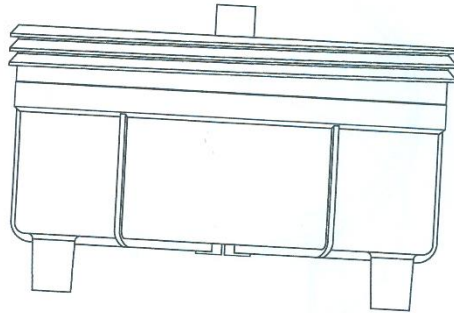

FIG. 2

.....  
(11): 2122 (45): 24/03/2026 (21): 2025/3387 (22): 15/05/2025 (30): (51): (Loc (6)):23-03 (54): HEATING CHAMBER (73): NASIB PAINTS AND HARDWARE LTD P. O. BOX 32745-00600 NAIROBI, Kenya (74): ,The features

for which novelty is claimed are the features of shape, configuration and ornamentation of the article as shown in the graphic representations



.....  
 (11): 2123 (45): 24/03/2026 (21): 2025/3388 (22): 15/05/2025 (30): (51): (Loc (6)):23-01 and 23-03 (54): TEMPERATURE SELECTOR SWITCH (73): NASIB PAINTS AND HARDWARE LTD P. O. BOX 32745-00600 NAIROBI, Kenya (74): ,The features for which novelty is claimed are the features of the shape ,configurations and ornamentation of the article as shown in the graphic representations.

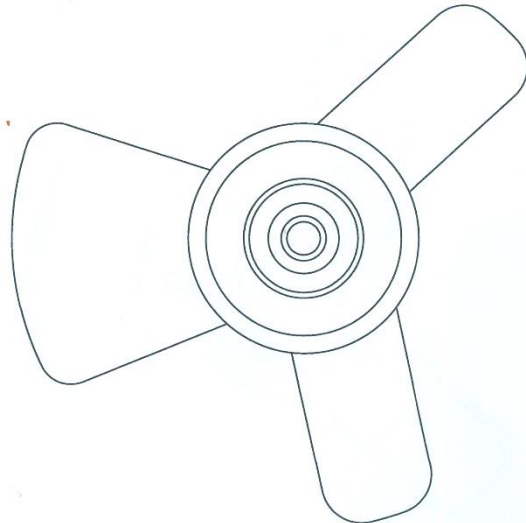

FIG. 1

.....

#### 7.4 Industrial Designs Renewed

(11) Design Number:1521 (22) Filing Date: 20/01/2021 (51) International Class. (Loc (6)):13-03 (54) Title: MCB DISTRIBUTION BOARD (73) Owner(s):AJ TRONICS FZCO P. O. BOX 61473, PLOT NO S30218, JEBEL ALI DUBAI, U.Arab Emirates (24) Registration extended up to: 20/01/2031

.....

(11) Design Number:1440 (22) Filing Date: 08/04/2021 (51) International Class. (Loc (6)):14-03 (54) Title: MOBILE PHONES (73) Owner(s):VIVO MOBILE COMMUNICATION CO., LTD. of No.168 Jinghai East Rd.,Chang'an Dongguan,Guangdong 523863,, China (24) Registration extended up to: 08/04/2031

.....

## 8.0 ARIPO APPLICATIONS

### 8.1 ARIPO Industrial Designs Registered

(11) Registration No.: 1680 (45) Registration date: 13/02/2026 (21) Application No.: 2024/1947 (22) Filing date: 23/09/2024 (30) Priority: 2024-006544 29/03/2024 JP (51): Classification: 09-01 (54) Article to which design is applied: CONTAINER BOTTLE (73) Owner: KEWPIE CORPORATION 4-13, Shibuya 1-Chome, Shibuya-Ku, Tokyo, Japan, Japan (74) Agent/ Address for service: SPOOR.FISHER, Total House (2nd Floor), 25 Liberia Road, P.O. Box GP 2319, Accra, Ghana



FIG. 1 Perspective view I

.....  
(11) Registration No.: 1673 (45) Registration date: 29/12/2025 (21) Application No.: 2025/2000 (22) Filing date: 08/04/2025 (30) Priority: 29/967,064 08/10/2024 US (51): Classification: (54) Article to which design is applied: POCKETS FOR CULTIVATING UNROOTED CUTTINGS WITHOUT A SUBSTRATE (73) Owner: P & G IP GMBH HanfÄcker 10 70378 Stuttgart, Germany, Germany (74) Agent/ Address for service: INVENTA MOZAMBIQUE, LDA., Av. 25 de Setembro, 1821 Maputo, Mozambique

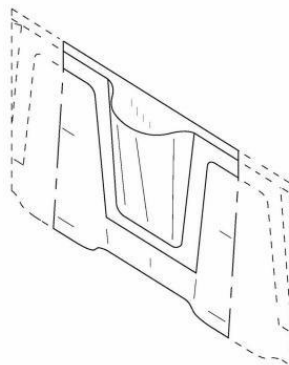

.....  
(11) Registration No.: 1686 (45) Registration date: 27/02/2026 (21) Application No.: 2025/2035 (22) Filing date: 15/09/2025 (30) Priority: A2025/00307 17/03/2025 ZA (51): Classification: 29-01 (54) Article to which design is applied: A MOBILE FIRE EXTINGUISHER STATION (73) Owner: RITESTAND (PTY) LTD. Plot 84, Elandsdrift, Mooinooi 0325, North West Province, South Africa, South Africa (74) Agent/ Address for service: ADAMS AND ADAMS MOZAMBIQUE, Rua EstevÃ£o AtaÃ-de, #20, R/C Bairro da Sommerschild, Maputo, Mozambique

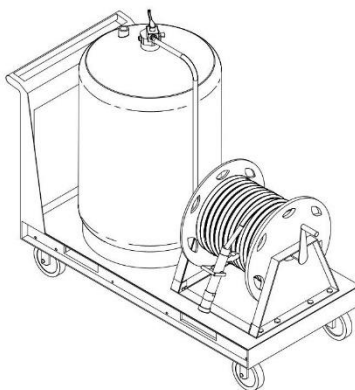

Fig. 1: Three-dimensional view from top

.....  
(11) Registration No.: 1681 (45) Registration date: 13/02/2026 (21) Application No.: 2025/2037 (22) Filing date: 19/09/2025 (30) Priority: (51): Classification: 02-04 (54) Article to which design is applied: FOOTWEARS (73) Owner: BATHU SWAG (PTY) LIMITED Bathu Headquarters, Arrow Business Park, 60 Rietspruit Road, Kosmosdal x11, Centurion 0187, Gauteng, South Africa, South Africa (74) Agent/ Address for service: ADAMS AND ADAMS MOZAMBIQUE, Rua Estevão Ata-de, #20, R/C Bairro da Sommerschield, Maputo, Mozambique

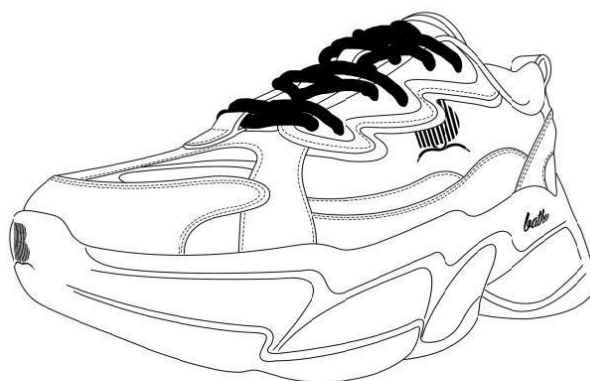

FIGURE 1: Three-dimensional view from front

.....

## **9.0 Trade Marks**

### **9.1 Applications accepted for registration**

NOTICE is given that any person who has grounds of opposition to the Registration of any of the trade marks advertised herein according to these classes may within sixty (60) days from the date of this Journal, lodge a notice of opposition on form TM. No. 6 (in duplicate) together with a fee of Ksh.5,000/= (local opponent) or US\$ 250 (foreign opponent). The period of lodging the notice of opposition may be extended by the Registrar as he deems fit and upon such terms as he may direct. Any request for such extension should be made to the Registrar to reach him before the expiry of the period allowed.

Formal opposition should not be lodged until after a reasonable notice has been given in writing to the applicant for registration to afford him any opportunity of withdrawing his application before the expense of preparing the notice of opposition is incurred. Failure to give such notice will be taken into account in considering any application by an opponent for an order for costs if the opposition is uncontested by the applicant.

Representations of the marks advertised herein can be seen at the Trade Marks Registry, Kenya Industrial Property Institute, KIPi Centre, Kabarsiran Avenue Off Waiyaki Way, Lavington, Nairobi.

**(210)** : 95178 **(220)** : 09/12/2016 **(300)** : None **(511)** : 30(Rice) **(526)** : Registration of this mark shall give no right to the exclusive use of the words "GOLD" and "SEAL" each separately and apart from the mark as a whole. **(730)** : LT FOODS MIDDLE EAST DMCC Incorporated in United Arab Emirates of Unit No. 707, BB2 Mazaya Business Avenue, JLT, Dubai, United Arab Emirates **(740)** : CFL Advocates of P. O. Box 23555 - 00100, Nairobi, Kenya

**GOLD SEAL INDUS VALLEY**

**(210)** : 96649 **(220)** : 31/03/2017 **(300)** : None **(511)** : 12(Motorcycle spare parts) **(526)** : None "SIMBA" is a Shona word meaning "Strength," "Strong" or "Power". **(730)** : RIYAZ DAMJI of P. O. Box 81694, Dubai, United Arab Emirates **(740)** : CFL Advocates of P. O. Box 23555 - 00100, Nairobi, Kenya



**(210)** : 97384 **(220)** : 29/05/2017 **(300)** : None **(511)** : 39(Arranging travel tours; travel tour conducting; travel tour operating and organizing; arranging and conducting jungle and safari expeditions for recreational purposes; travel arrangements; travel advisory information and services; transport) **(526)** : BUSHRegistration of this mark shall give no right to the exclusive use of the words "BUSH" and "TRACKS" each separately apart from the mark a whole. **(730)** : DAVID TETT a United Kingdom citizen of c/o Bushtracks African Expeditions, Inc., 824 Healdsburg Avenue, Healdsburg, CA 95448, United States of America **(740)** : Coulson Harney LLP of P. O. Box 10643 - 00100, Nairobi, Kenya

**BUSHTRACKS**

**(210)** : 98348 **(220)** : 02/08/2017 **(300)** : None **(511)** : 5(Pharmaceuticals and other preparations for medical or veterinary purposes), 29(Meat, fish, poultry and game, meat extracts; preserved, frozen, dried and cooked fruits and vegetables; jellies, jams, compotes; eggs; milk and milk products; edible oils and fats) and 30(Coffee, tea, cocoa and artificial coffee, rice, tapioca and sago, flour and preparations made from cereals; bread, pastry and confectionery; ices; sugar, honey, treacle; yeast, baking-powder; salt; mustard; vinegar, sauces (condiments); spices; ice) **(526)** : Registration of this mark shall give no right to the exclusive use of the words "SUGAR" and "FREE" each separately and apart from then mark as a whole. **(730)** : ZYDUS WELLNESS LIMITED a public company duly incorporated in India of Zydus Tower, Satellite Cross Roads, Ahmedabad, Gujarat, 380 015, India **(740)** : CFL Advocates of P. O. Box 23555, 00100, Nairobi, Kenya

**SUGAR FREE**

**(210)** : 102691 **(220)** : 22/06/2018 **(300)** : None **(511)** : 3(soaps, bleach, toilet cleaner, window cleaner) and 21(Mops,Scrubbing brushes) **(526)** : None **(730)** : ASMI GLOW HOLDING LIMITED Manufacturing of P. O. Box 24582 - 00100, Nairobi, Kenya **(740)** : None,



**(210)** : 107520 **(220)** : 27/05/2019 **(300)** : None **(511)** : 36(Online banking services; credit card, debit card, store card, bank card, charge card, gift voucher card, other payment card authorisation services; electronic funds transfer and payment services; processing of transactions made by credit cards, debit cards, store cards, bank cards, charge cards, gift voucher cards, other payment cards and microchips containing account details; card to card transfer and mobile banking and payments; processing of credit and debit transactions by telecommunication link; electronic wallet services (payment services); e-wallet account services, namely the provision of online electronic money accounts (e-wallet accounts) and services for consumers and online merchants whereby consumers fund their e-wallet accounts and consumers and online merchants (businesses) send and receive payments and remittances over the Internet; services for secure transfer of



money between banks, their customers and merchant accounts; financial transaction services for processing payments electronically including processing payments over a web based platform) and 42(Updating software of electronic data capture and transmission systems for the purposes of electronic funds transfer; monitoring of card readers and electronic apparatus all for handling financial and associated transactions including authorisation and processing of payments made with credit cards, debit cards, store cards, bank cards, charge cards, gift voucher cards, other payment cards and microchips containing account details; design and development of computer hardware and software; computer software programming services; application service provider (ASP) services featuring mobile phone and wireless handheld computer applications software for use in enabling users to make electronic payments and to receive, redeem, and manage electronic receipts and electronic coupons; lease, hire and rental of computer equipment, hardware, software and programs; encryption services; electronic signature verification and authorisation services; digital signature verification and authorisation services; information, advisory and consultancy services related to all the aforesaid services; design, programming, development, support and maintenance services of computer software relating to processing payments; design, programming, development, support and maintenance services of computer software for processing electronic payments and transferring funds utilising credit cards, virtual credit cards, charge cards, debit cards and stored value cards) **(526)** : ERegistration of this mark shall give no right to the exclusive use of the letter "E" and the words "LIPA" and "CONVENIENT" each separately and apart from the mark as a whole. The application is limited to the colours blue and yellow/ gold (RGB 247 141 32) **(730)** : ELIPA MAURITIUS LIMITED of c/o Mauri Experts Ltd, 12th Floor, Tower 1, Nexteracom Towers, Cybercity, Ebene, Mauritius **(740)** : Ndungu Njoroge & Kwach Advocates of P. O. Box 41546 - 00100, Nairobi, Kenya

**(210)** : 110576 **(220)** : 13/01/2020 **(300)** : None **(511)** : 6(Common metals and their alloys; metal building materials; scaffolding; transportable buildings of metal; materials of metal for railway tracks; non-electric cables and wires of common metal; ironmongery, small items of metal hardware; pipes and tubes of metal; safes; goods of common metal not included in other classes; ores; guard rails, ladders, platforms, staircases, stair treads and steps; parts, fittings, accessories and components for these goods in class 6) and 37(Building construction; repair; installation services; hire, maintenance and supply of building materials and equipment, including in particular scaffolding and formwork; erection of building materials in particular scaffolding and formwork) **(526)** : None **(730)** : WACO AFRICA (PTY) LIMITED a South African Company of 181 Barbara Road, Elandsfontein, Johannesburg, Gauteng, South Africa **(740)** : Coulson Harney LLP of P. O. Box 10643 - 00100, Nairobi, Kenya

**(210)** : 120071 **(220)** : 12/11/2021 **(300)** : None **(511)** : 5(Pharmaceuticals) **(526)** : None **(730)** : NESHER PHARMA LTD Wholesalers /Distributors of P. O. Box 2216 - 30100, Eldoret, Kenya **(740)** : None,



(210) : 122053 (220) : 13/04/2022 (300) : None (511) : 5(Fungicide) (526) : Registration of this mark shall give no right to the exclusive use of the word 'CURE', the numerals '2', "5", "0" and the letters 'E' and "W" each separately and apart from the mark as a whole. 'DOKTA' is a slang word for Doctor.(730) : JOJEMI CHEMICALS of P. O. Box 953 - 00600, Nairobi, Kenya (740) : None,

**JOJEMI DOKTA CURE  
250EW**

(210) : 127804 (220) : 15/05/2023 (300) : None (511) : 5(Veterinary pharmaceuticals) (526) : LIFERegistration of this mark shall give no right to the exclusive use of the word "LIFE", the letters "S", "D" and "M" each separately and apart from the mark as a whole. (730) : LIFEKEN LIMITED of P. O. Box 38206 - 00623, Nairobi, Kenya (740) : None,

**SDMLIFE**

(210) : 128594 (220) : 23/06/2023 (300) : None (511) : 5(Pharmaceuticals) (526) : Registration of this mark shall give no right to the exclusive use of the letters "D" and "T" each separately and apart from the mark as a whole. (730) : NESHER PHARMA LTD of P. O. Box 2216-30100, Kenya (740) : None,

**ACYCIOTAB.DT.**

(210) : 128993 (220) : 14/07/2023 (300) : None (511) : 35(Organization of exhibitions for commercial or advertising purposes) (526) : Registration of this mark shall give no right to the exclusive use of the words 'SHARE' and 'EXPO' each separately and apart from the mark as a whole. (730) : WATERMARK CONSULTANTS of P. O. Box 4693 - 00100, Nairobi, Kenya (740) : None,



(210) : 129616 (220) : 22/08/2023 (300) : None (511) : 35(Business, catering and hotel management consultancy; business advisory services relating to franchising; business management of hotels and motels and other temporary accommodation including serviced apartments and apartment hotels; public relations services in relation to temporary accommodation, including hotels and motels, serviced apartments and apartment hotels; marketing of temporary accommodation including hotels and motels, serviced apartments and apartment hotels including the advertising of the aforementioned services via the Internet and other global computer networks) and 43(Hotel services; temporary accommodation services; provision of temporary housing accommodation; provision of serviced apartments; preparation and serving of food and drink; catering (food and drink); lounge, bar, wine bar, snack bar, juice bar, coffee bar, restaurant and cafe services; rental of dining facilities; rental of meeting rooms; room hire; provision of room services to hotel guests; hotel and restaurant reservation services) (526) : Registration of this Mark shall give no right to the words "HOTELS" and "RESORTS" each separately and apart from the Mark as a whole. (730) : MILLENIUM & COPTHONE INTERNATIONAL LIMITED of 9 Raffles Place, #12-01 Republic Plaza, Singapore 048619, Singapore (740) : Ndungu Njoroge & Kwach Advocates of P. O. Box 41546 - 00100, Nairobi, Kenya

 **MILLENNIUM**  
HOTELS AND RESORTS

(210) : 129799 (220) : 01/09/2023 (300) : None (511) : 5(Pharmaceutical preparations; dietary supplements; food supplements; nutritional supplements) (526) : None (730) : UPSA SAS of 3 rue Joseph Monier, 92500 Rueil - Malmaison, France (740) : Ndungu Njoroge & Kwach Advocates of P. O. Box 41546 - 00100, Nairobi.



---

**(210)** : 129869 **(220)** : 07/09/2023 **(300)** : None **(511)** : 12(Automobiles, sports cars, vans [vehicles], trucks, motor buses, electric vehicles, SUVs) **(526)** : Registration of this mark shall give no right to the exclusive use of the word "ELECTRIC" each separately and apart from the mark as a whole. **(730)** : HYUNDAI MOTOR COMPANY of 12, Heolleung-ro, Seocho-gu, Seoul 06797, Republic of Korea **(740)** : Ndungu Njoroge & Kwach Advocates of P. O. Box 41546 - 00100, Nairobi, Kenya.

---

**Mighty Electric**

**(210)** : 130645 **(220)** : 25/10/2023 **(300)** : No. UK00003915687 dated 25/05/2023 in the United Kingdom **(511)** : 3(Perfume, cologne, aftershave; deodorants; cosmetics; make up preparations; hair lotions, shampoos, conditioners; soaps; perfumery, essential oils; personal hygiene products; cosmetic kits; creams for cosmetic purposes; shaving preparations; toiletries; skin and hair care preparations), 9(Optical apparatus; eyewear; glasses; sunglasses; spectacle frames; cases adapted for glasses and sunglasses; eyeglass frames; eyeglass chains; holders adapted for glasses and sunglasses; eyeglass cords; leather cases and holders adapted for glasses and sunglasses; fashion spectacles; protective clothing, footwear and headgear; eyeglasses for sports; parts for spectacles; head guards for sports; helmets for use in sports; mouth guards for sports; cell phone straps; cases for mobile phones, computers and tablets; carriers for mobile phones computers and tablets; headphones; earphones; mobile phone headsets; audio equipment; audio-visual apparatus; speakers; wireless speakers; cases, covers, bags and carriers adapted for all the aforesaid goods; application software for smart phones; computer application software; downloadable smart phone application software; downloadable computer software events and competitions; providing sports facilities; information, advice and consultancy services in relation to all the aforesaid services) **(526)**: Registration of this mark shall give no right to the exclusive use of the surname 'ORIGI' separately and apart from the mark as a whole. However the surname ORIGI shall only be available for registration to person who legitimately have the Surname ORIGI. **(730)** : DIVOCK ORIGI of 71 Queen Victoria Street, London, EC4V 4BE, United Kingdom **(740)** : CFL ADVOCATES of P. O. Box 23555 - 00100, Nairobi, Kenya

---

**—ORIGI**

**(210)** : 130847 **(220)** : 07/11/2023 **(300)** : None **(511)** : 18(Bags; purses; change purses~ pouches; vanity cases, not fitted; business card cases; card cases [notecases]; pocket wallets; leather straps; handbag and purse frames; frames for pouches; frames for bags [structural parts of bags]; frames for coin purses [structural parts of coin purses]; shoulder belts, shoulder straps, and straps for bags, pouches, and purses; shoulder pads for shoulder belts, shoulder straps, and straps for bags, pouches, and purses; handles and grips for bags, pouches, and purses; patches for belts and straps for bags, pouches, and purses) and 26(Slide fasteners [zippers]; hook and pile fastening tapes; adjustable fasteners for clothing, footwear, headgear and bags; zip fasteners for reclosable plastic bags; buttons; snap buttons [snap fasteners]; ornamental novelty buttons; hooks and eyes; hooks [haberdashery]; eyelets for clothing; shoe eyelets; buckles for clothing; shoe buckles; snap hooks; cord stoppers; cord end stoppers; elastic ribbons; webbing in the nature of woven fabric tapes for sewing purposes; buckles in the nature oftape adjusters; slide fasteners and parts thereof; zipper pulls; plastic pullers to be attached to cord ends of clothing, bags and pouches; metal fittings for bags; clasps for bags, pouches and purses; fastenings

---

 **YKK  
DIGITAL  
SHOWROOM**

for bags, pouches, and purses; buckles for bags, pouches, and purses; length adjusters for shoulder belts, shoulder straps, and straps for bags, pouches, and purses; hooks for belts and straps for bags, pouches, and purses; buckles for backpacks, travel bags, and bags for sports; zip fasteners for bags; clasps for bags; buckles for bags; clasps for coin purses; clasp fasteners; fastenings for clothing) (526) : Registration of this mark shall give no right to the exclusive use of the letters 'K' and 'Y' each separately and apart from the mark as a whole. (730) : YKK CORPORATION of 1, Kanda Izumi-cho, Chiyoda-ku Tokyo, Japan (740) : Ndungu Njoroge & Kwach Advocates of P. O. Box 41546 - 00100, Nairobi, Kenya.

(210) : 130993 (220) : 16/11/2023 (300) : None (511) : 5(Pharmaceuticals) (526) : Registration of this mark shall give no right to the exclusive use of the letter 'M' separately and apart from the mark as a whole. (730) : NESHER PHARMA LTD of P. O. Box 2216 - 30100, Eldoret, Kenya (740) : None,

SITANEP-M

210) : 131115 (220) : 23/11/2023 (300) : None (511) : 18(Bags; purses; change purses; pouches; vanity cases, not fitted; business card cases; card cases [notecases]; pocket wallets; leather straps; handbag and purse frames; frames for pouches; frames for bags [structural parts of bags]; frames for coin purses [structural parts of coin purses]; shoulder belts, shoulder straps, and straps for bags, pouches, and purses; shoulder pads for shoulder belts, shoulder straps, and straps for bags, pouches, and purses; handles and grips for bags, pouches, and purses; patches for belts and straps for bags, pouches, and purses) and 26(Slide fasteners [zippers]; hook and pile fastening tapes; adjustable fasteners for clothing, footwear, headgear and bags; zip fasteners for reclosable plastic bags; buttons; snap buttons [snap fasteners]; ornamental novelty buttons; hooks and eyes; hooks [haberdashery]; eyelets for clothing; shoe eyelets; buckles for clothing; shoe buckles; snap hooks; cord stoppers; cord end stoppers; elastic ribbons; webbing in the nature of woven fabric tapes for sewing purposes; buckles in the nature of tape adjusters; slide fasteners and parts thereof; zipper pulls ; plastic pullers to be attached to cord ends of clothing, bags and pouches; metal fittings for bags; clasps for bags, pouches and purses; fastenings for bags, pouches, and purses; buckles for bags, pouches, and purses; length adjusters for shoulder belts, shoulder straps, and straps for bags , pouches, and purses; hooks for belts and straps for bags, pouches, and purses; buckles for backpacks, travel bags, and bags for sports; zip fasteners for bags; clasps for bags; buckles for bags; clasps for coin purses; clasp fasteners; fastenings for clothing) (526) : Registration of this mark shall give no right to the exclusive use of the word 'PLUS' and the '+' sign separately and apart from the mark as a whole.(730) : YKK CORPORATION of 1, Kanda izumi-Cho, Chiyoda-ku, Tokyo 101-8642, Japan (740) : Ndungu Njoroge & Kwach Advocates of P. O. Box 41546 - 00100, Nairobi, Kenya.

NATULON Plus

(210) : 131117 (220) : 23/11/2023 (300) : None (511) : 18(Bags; purses; change purses; pouches; vanity cases, not fitted; business card cases; card cases [notecases]; pocket wallets; leather straps; handbag and purse frames; frames for pouches; frames for bags [structural parts of bags]; frames for coin purses [structural parts of coin purses]; shoulder belts, shoulder straps, and straps for bags, pouches, and purses; shoulder pads for shoulder belts, shoulder straps, and straps for bags, pouches, and purses; handles and grips for bags, pouches, and purses; patches for belts and

NATULON Plus

straps for bags, pouches, and purses) and 26(Slide fasteners [zippers]; hook and pile fastening tapes; adjustable fasteners for clothing, footwear, headgear and bags; zip fasteners for reclosable plastic bags; buttons; snap buttons [snap fasteners]; ornamental novelty buttons; hooks and eyes; hooks [haberdashery]; eyelets for clothing; shoe eyelets; buckles for clothing; shoe buckles; snap hooks; cord stoppers; cord end stoppers; elastic ribbons; webbing in the nature of woven fabric tapes for sewing purposes; buckles in the nature of tape adjusters; slide fasteners and parts thereof; zipper pulls; plastic pullers to be attached to cord ends of clothing, bags and pouches; metal fittings for bags; clasps for bags, pouches and purses; fastenings for bags, pouches, and purses; buckles for bags, pouches, and purses; length adjusters for shoulder belts, shoulder straps, and straps for bags, pouches, and purses; hooks for belts and straps for bags, pouches, and purses; buckles for backpacks, travel bags, and bags for sports; zip fasteners for bags; clasps for bags; buckles for bags; clasps for coin purses; clasp fasteners; fastenings for clothing) (526) : Registration of this trademark shall give no rights to the exclusive use of the word "PLUS" separately and apart from the mark as a whole. (730) : YKK CORPORATION of 1, Kanda izumi-Cho, Chiyoda-ku, Tokyo 101-8642, Japan (740) : Ndungu Njoroge & Kwach Advocates of P. O. Box 41546 - 00100, Nairobi, Kenya.

(210) : 131293 (220) : 05/12/2023 (300) : None (511) : 5(Pharmaceutical ) (526) : Registration of this mark shall give no right to the exclusive use of the letters 'D' and 'T' each separately and apart from the mark as a whole. (730) : NESHER PHARMA LIMITED of P. O Box 2216 - 30100, Eldoret, Kenya (740) : None,

## CLAVUCURE DT

(210) : 132057 (220) : 01/02/2024 (300) : None (511) : 16(Tissues) (526) : Registration of this mark shall give no right to the exclusive use of the words 'FEATHER', 'SOFT' and the device of a FLOWER each separately and apart from the mark as a whole. (730) : RUWETON INTERNATIONAL LTD of P. O. Box 2171 - 20200, Kericho, Kenya (740) : None,



(210) : 132484 (220) : 28/02/2024 (300) : None (511) : 18(Pocketbooks, handbags, shoulder bags, clutches, wristlet bags, coin purses, wallets, credit card cases, business card cases, tote bags, backpacks, sports bags, book bags, beach bags, tote bags, diaper bags, cosmetic bags sold empty, travel cases, luggage, umbrellas) and 25(Clothing apparel: Infants clothing, bandanas, bath robes, bathing trunks, bathing suits/swimsuits, beach clothes, belts, bibs, brassieres, camisoles, clothing of imitations of leather, clothing of leather, coats, wraps, dresses, dressing gowns, ear muffs, stoles, gloves, headbands, hosiery, jackets, jeans, jerseys, knitwear, costumes, mittens, neckties, outerwear, overcoats, topcoats, pants, parkas, ponchos, pullovers, jumpers, pajamas, sarongs, sashes, scarves/scarfs, shawls, shirts, short-sleeve shirts, sports jerseys, polo shirts, rugby shirts, skirts, skorts, shorts, sleep masks, slippers, socks, suits, suspenders, underclothing [underwear], sweaters, teddies, tee-shirts, tights, trousers, uniforms, veils, vests, waterproof clothing; Headgear : beanies, ball caps, hats, skull caps, top hats, visors, berets



---

; Footwear, sandals, slippers, boots, athletic shoes, dress shoes, heels, soles, laces, metal fitting for footwear) **(526)** : None **(730)** : UNITED STATES POLO ASSOCIATION of 1400 Centrepark Blvd., Suite 200, West Palm Beach, FL 33401, United States of America **(740)** : Ndungu Njoroge & Kwach Advocates of P. O. Box 41546 - 00100, Nairobi, Kenya.

---

**(210)** : 132629 **(220)** : 05/03/2024 **(300)** : None **(511)** : 30(Coffee, tea, cocoa and artificial coffee; rice; tapioca and sago; flour and preparations made from cereals; bread, pastry and confectionery; ices; sugar, honey, treacle; yeast, baking powder; salt; mustard; vinegar, sauces (condiments); spices; ice; production and sale of natural flour of cassava, flesh orange sweet potatoes and palm millet for human consumption) **(526)** : Registration of this mark shall give no right to the exclusive use of the words 'AGRIBUSINESS', 'INNOVATION', 'SUSTAINABILITY', 'NATURALS', 'GREEN', 'WITHOUT', 'BORDERS' and the device of 'GLOBE' and other devices thereof each separately and apart from the mark as a whole including the devices as presented MUGALA is a name of a person and has no meaning in English. **(730)** : ANDREW EGALA MUGALA Production and sale of natural foodstuffs of P. O. Box 843 - 50100, GREEN COURT - SHITUNGI, Kenya **(740)** : Fredrick O. Otswong'o of P. O. Box 54708 - 00200, Nairobi, Kenya

---

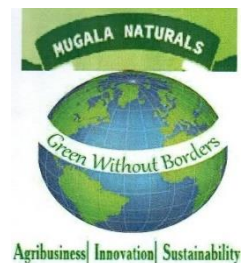

---

**(210)** : 132757 **(220)** : 13/03/2024 **(300)** : None **(511)** : 9(Telecommunication devices and apparatus; recording media, such as magnetic discs, magnetic tapes, IC cards stored with computer programs downloadable by communication networks; digital recording media stored with computer programs; optical data media; magnetic data media; integrated circuit cards [smart cards]; computer software; computer software applications, downloadable; computer software, recorded; computer programs [downloadable software]; computer programs, recorded; downloadable application software for virtual environments; computers; computer hardware; computer peripheral devices; data processing apparatus; electronic machines and apparatus and their parts; blank recording media; downloadable musical sound recordings; downloadable music files; downloadable video recordings; downloadable image files; electronic publications, downloadable; digital recording media recorded with text and image information of newspapers, magazines, books, maps and photographs; downloadable text and image information of newspapers, magazines, books, maps and photographs; wearable computers; data sets, recorded or downloadable quantum computers; downloadable cryptographic keys for receiving and spending crypto assets; cryptocurrency hardware wallets; downloadable digital music files authenticated by non-fungible tokens [NFTs]; downloadable digital image files authenticated by nonfungible tokens [NFTs]), 35(Advertising and providing information relating thereto; rental of advertising space and providing information relating thereto; rental of advertising space on web sites; sales promotion for others through trading stamp schemes; business management analysis; business consultancy; business consultancy services for digital transformation; business appraisals; business information; providing market research information about customers; business management for others of customer information through the use of computers; marketing research, market analysis and consulting services related thereto; providing information concerning commercial sales; providing commercial information; commercial information agency services;

---



---

providing information in the field of economics; economic forecasting and analysis; providing business information on trend of individual industry; provision of business statistical information; providing statistical information for business or commercial purposes; providing market research statistical information; analysis of market research data and statistics; drawing up of statements of accounts and providing information on preparation, auditing or attesting of financial statements; filing of documents or magnetic tapes [office functions] and providing information relating thereto; office functions; business assistance; providing business information relating to office functions; systemization and compilation of information into computer databases and providing information relating thereto; updating and maintenance of data in computer databases; computerized file management; providing employment information; business research; business investigations; business management assistance; business management consultancy for business process improvement; human resources consultancy; word processing; computerized word processing; providing information concerning clerical services; providing information for the sales of goods by the Internet or mobile telephone communication or other communication means and providing information for other sales of goods; business information, namely providing business information on business management and market research; business information, namely providing business information for corporate profiles; business information, namely providing business information for corporate organization; business information, namely providing business information for corporate personnel affairs; economic analysis for business decisions; economic forecasting; data processing services [office functions]; provision of an online marketplace for buyers and sellers of downloadable digital image files authenticated by non-fungible tokens [NFTs]), 37(Installation, maintenance and repair of telephone and communication equipment and providing information relating thereto; computer installation and repair and providing information relating thereto; installation, maintenance and repair of computer hardware and providing information relating thereto; construction and providing information relating to the same; construction consultancy; repair or maintenance of electronic machines and apparatus and providing information relating thereto; repair or maintenance of telecommunication machines and apparatus and providing information relating thereto; installation of communication equipment for remote communication network system and providing information relating to the same; installation, maintenance and repair of cloud computing network hardware and cloud computing platform hardware), 38(Telecommunications and providing information relating thereto; providing telecommunications connections to a global computer network; consultancy services relating to telecommunications; transmission of data and providing information relating thereto; computer aided transmission of messages and images; broadcasting services and providing information relating thereto; rental of telecommunication equipment, including telephones and facsimile apparatus and providing information relating thereto; streaming of data; providing access to the Internet and other communications networks; providing access to databases; rental of access time to global computer networks; communication computers terminal and other communication machines and apparatus, and providing information relating thereto; rental of by access time to

---

---

computer databases via the Internet, cellular telephone networks or other telecommunication means; geolocation services [telecommunications services]; providing chatrooms in virtual environments; providing access to blockchain networks; telecommunications routing and junction services) and 42(Computer software design, computer programming, or maintenance of computer software; design, programming and maintenance of computer software; consultancy, advisory services and providing information relating to computer software design, computer programming, or maintenance of computer software; consultancy and information services relating to the design, programming and maintenance of computer software; computer system design, creating or maintenance of computer systems; consultation, advisory services and providing information relating to computer system design, creating or maintaining of computer systems; creating or maintaining home pages for others on the Internet; technological consultancy services relating to security on communication network by the Internet, mobile telephone communication or other communication means; computer security consultancy; data security consultancy; providing authentication of personal identification information; inspection, verification and authentication of existence of falsification of contents of electronic information; encryption of data for computers; providing search engines by the Internet, mobile telephone communication or other communication means; providing search engines for the Internet; conversion of sound, image and text information to sound, image and text signals by computers; data conversion to computer databases; conversion of computer programs and data, other than physical conversion; conversion of data or documents from physical to electronic media; conversion of images from physical to electronic media; digitization of documents [scanning]; design, development and maintenance of computer software for data processing; remote monitoring of computer systems; installation, upgrading, maintenance and configuration of computer programs; installation, upgrading, maintenance and configuration of computer programs relating to central processing units, electronic circuits, magnetic discs, magnetic tapes storing computer programs and other peripheral equipment; verification of connection between computers; testing services in relation to computer program behavior; computer software consulting concerning maintenance and installation of computer programs to apparatuses using computer programs or apparatuses used by computer systems; information technology [IT] consultancy; rental of computers and providing information relating thereto; providing computer programs on data network and providing information relating thereto; providing temporary use of on-line non-downloadable software; software as a service [SaaS]; rental of web servers; rental of memory space of servers for communication networks; rental of electronic memory space [web space] on the Internet; electronic data storage; technical writing for others, namely, writing of specialized user manuals for computers, computer programs and computer hardware; technical writing; technical advice relating to operation of computers and computer software; quality control; providing technical information relating to computer software design, computer programming, or maintenance of computer software using the Internet, mobile telephone communication or other communication means; designing, creating and maintaining of home pages for advertising on the Internet; consulting services in the field of cloud computing; data migration services; providing

---

computer programs for use in definition, acquisition and implementation of management information systems in the field of enterprise resource planning implementation services; research and development of computer technologies; research and consultancy in the computing sector; infrastructure as a service [IaaS]; platform as a service [PaaS]; computer system integration services; computer security services in the nature of providing authentication, issuance, validation and revocation of digital certificates; information technology [IT] consultancy in the field of datacenter architecture, public and private cloud computing solutions, and evaluation and implementation of Internet technology and services; providing information relating to designing, creating and maintaining of computer programs against computer virus; providing virtual computer systems through cloud computing; quantum computing; consulting services in the field of quantum computing; research in the field of quantum simulation; rental of data centre facilities; technological consultancy services for digital transformation; providing geographic information; providing online geographic maps, not downloadable; artificial intelligence consultancy; research in the field of artificial intelligence technology; hosting software platforms for virtual reality based work collaboration; hosting virtual environments; crypto mining; blockchain as a service [BaaS].) (526) : Registration of this mark shall give no right to the exclusive use of the letters 'N', 'T' and the word 'DATA' each separately and apart from the mark as a whole. (730) : NIPPON DENSHIN DENWA KABUSHIKI KAISHA ALSO TRADING AS NIPPON TELEGRAPH AND TELEPHONE CORPORATION of 5-1 Otemachi 1- Chome, Tokyo, Japan (740) : J. K. Muchae & Co Advocates of P. O. Box 60664 - 00200, Nairobi, Kenya

(210) : 132950 (220) : 27/03/2024 (300) : None (511) : 43(Restaurant) (526) : Registration of this mark shall give no right to the exclusive use of the words 'BOTTEGA', 'ITALIAN' and 'BISTRO' each separately and apart from the mark as a whole. The English translation of the Italian word 'BOTTEGA' is 'Shop' while the English meaning of the French word 'BISTRO' is a Small Simple Restaurant. (730) : LEMOC LIMITED of P. O. Box 4622 - 00506, Nairobi, Kenya (740) : None,

**BOTTEGA ITALIAN  
BISTRO**

(210) : 133394 (220) : 30/04/2024 (300) : None (511) : 43(Service for providing food and drink; temporary accomodation) (526) : Registration of this mark shall give no right to the exclusive use of the words 'CLUB' and 'X' each separately and apart from the mark as a whole. (730) : MORRIS MACHARIA MBUTHI of P. O. Box 13147 - 00200, Nairobi, Kenya (740) : None,

**CLUB X**

(210) : 133712 (220) : 17/05/2024 (300) : None (511) : 9(Scientific, nautical, surveying, photographic, cinematographic, optical, weighing, measuring, signaling, checking (supervision), life-saving and teaching apparatus and instruments; apparatus and instruments for conducting, switching, transforming, accumulating, regulating or controlling electricity; apparatus for recording, transmission or reproduction of sound or images; magnetic data carriers, recording discs; compact discs, DVDs and other digital recording media; mechanisms for coin-operated apparatus; cash registers, calculating machines, data processing equipment, computers; computer software; fire-extinguishing apparatus) and 42(Scientific and technological services and research and design relating thereto; industrial analysis and research services; design and development of computer hardware



---

and software) **(526)** : None **(730)** : EXHIBIT IT SOLUTIONS LIMITED of P. O. Box 16258 - 00610, nairobi, Kenya **(740)** : None,

---

**(210)** : 134543 **(220)** : 17/07/2024 **(300)** : None **(511)** : 35(Business, catering and hotel management consultancy; business advisory services relating to franchising; business management of hotels and motels and other temporary accommodation including serviced apartments and apartment hotels; public relations services in relation to temporary accommodation, including hotels and motels, serviced apartments and apartment hotels; marketing of temporary accommodation including hotels and motels, serviced apartments and apartment hotels including the advertising of the aforementioned services via the Internet and other global computer networks) and 43(Hotel services; temporary accommodation services; provision of temporary housing accommodation; provision of serviced apartments; preparation and serving of food and drink; catering (food and drink); lounge, bar, wine bar, snack bar, juice bar, coffee bar, restaurant and cafe services; rental of dining facilities; rental of meeting rooms; room hire; provision of room services to hotel guests; hotel and restaurant reservation services) **(526)** : Registration of this mark shall give no right to the exclusive use of the word 'RESIDENCES' separately and apart from the mark as a whole. **(730)** : MILLENNIUM & COPTHORNE INTERNATIONAL LIMITED of 9 Raffles Place, #12-01 Republic plaza, Singapore 048619, Singapore **(740)** : Ndungu Njoroge & Kwach Advocates of P. O. Box 41546 - 00100, Nairobi, Kenya

---



**(210)** : 134988 **(220)** : 13/08/2024 **(300)** : None **(511)** : 35(The burging together, for the benefit of others, of a variety of goods excluding the transport thereof, enabling customers to conveniently view and purchase those goods; such services may be provides by retail stores, wholesale outlets, through vending machines, mail order catalogues or by means of electronic media for example through websites at television shopping programmes) **(526)** : Registration of this mark shall give no right to the exclusive use of the words 'MOSAIC' and 'HEALTH' each separately and apart from the mark as a whole. **(730)** : ADAM MATHEW LEWIS of P. O. Box 1706 - 00606, Nairobi, Kenya **(740)** : None,

---

**MOSAIC HEALTH**

**(210)** : 135517 **(220)** : 18/09/2024 **(300)** : None **(511)** : 17(Adhesive) **(526)** : Registration of this mark shall give no right to the exclusive use of the words 'BOND', 'SEALANTS' and 'ADHESIVES' each separately and apart from the mark as a whole. **(730)** : BONDKRAFT ADHESIVE LIMITED of P. O. Box 38478 - 00100, Nairobi, Kenya **(740)** : None,

---



**(210)** : 136249 **(220)** : 04/11/2024 **(300)** : None **(511)** : 34(Cigarettes; tobacco, raw or manufactured; roll your own tobacco; pipe tobacco; tobacco products; tobacco substitutes (not for medical purposes); cigars; cigarillos; cigarette lighters for smokers; cigar lighters for smokers; matches; smokers' articles; cigarette paner; cigarette tubes; cigarette filters; pocket apparatus for rolling cigarettes; hand held machines for injecting tobacco into paper tubes; electronic cigarettes; liquids for electronic cigarettes; tobacco products for the purpose of being heated; electronic devices and their parts for the purpose of heating tobacco) **(526)** : None **(730)** : ROTHMANS of Pall Mall Limited of Route de France 17, Boncourt 2926, Switzerland **(740)** : Iseme Kamau & Maema Advocates of P. O. Box 11866 - 00400, Nairobi, Kenya

---

**RUBY**

(210) : 136262 (220) : 05/11/2024 (300) : None (511) : 5(Pest Control Products - preparations for destroying vermin; fungicides, herbicides) (526) : None (730) : JUANCO GROUP LIMITED of P. O. Box 381 - 00502, Karen, Nairobi, Kenya (740) : None,

### CLIAMAIT

(210) : 136503 (220) : 21/11/2024 (300) : None (511) : 5(Diapers and Sanitary Pads) (526) : Registration of this mark shall give no right to the exclusive use of the word 'COMFORT' each separately and apart from the mark as a whole. (730) : AFRICAN QUEEN NO.1 DISTRIBUTORS of P. O. Box 38681 - 00100, Nairobi, Kenya (740) : None,



(210) : 136643 (220) : 29/11/2024 (300) : None (511) : 9(Motor vehicle batteries) (526) : Registration of this mark shall give no right to the exclusive use of the words 'BATTERY' and 'CHAPCHAP' each separately and apart from the mark as a whole. 'CHAPCHAP' is a Swahili word which means 'Very Fast' in English. (730) : TIRE WORLD LIMITED of P. O. Box 18336 - 00500, Nairobi, Kenya (740) : None,

### BATTERY ChapChap

(210) : 136789 (220) : 10/12/2024 (300) : None (511) : 3(Cosmetics; make-up powder; eyebrow cosmetics; soap; beauty masks; cleansing milk for toilet purposes; perfumes; air fragrance reed diffusers; shampoos; breath freshening sprays; Wax melts [fragrancing preparations]; cosmetic pencils; lip glosses; lipsticks; balms other than for medical purposes; lotions for cosmetic purposes; mascara; bath preparations, not for medical purposes; cleaning preparations; cosmetics for animals; laundry preparations.) (526) : Registration of this mark shall give no right to the exclusive use of the word 'LEAF' separately and apart from the mark as a whole. (730) : Yiwu Yaotaiyue Cosmetics Co., Ltd of Floor 1, No.1, Building 15, Chengchun 3rd District, Futian Street, Yiwu City Zhejiang, China (740) : Gitahi Munyi & Associates of P. O. Box 19785 - 00100, Nairobi, Kenya

### Leaf Poem

(210) : 136937 (220) : 17/12/2024 (300) : None (511) : 43(Services for providing food and drink; temporary accommodation) and 44(Medical services; veterinary services; hygienic and beauty care for human beings or animals; agriculture, aquaculture, horticulture and forestry services) (526) : Registration of this mark shall give no right to the exclusive use of the word 'BODY' separately and apart from the mark as a whole 'MANAMA' is an Arabic word meaning 'THE PLACE OF REST' in English. (730) : MANAMA LIMITED of P. O. Box 2185 - 00100, Nairobi, Kenya (740) : None,



(210) : 136994 (220) : 18/12/2024 (300) : None (511) : 2(Paints) (526) : Registration of this mark shall give no right to the exclusive use of the words 'HERMOSA', 'WEATHER' and 'GUARD' each separately and apart from the mark as a whole. (730) : HERMOSA PAINTS LIMITED of P. O. Box 78895 - 00507, Nairobi, Kenya (740) : None,



(210) : 137278 (220) : 16/01/2025 (300) : None (511) : 32(Purified Drinking Water) (526) : Registration of this mark shall give no right to the exclusive use of the words 'SPRING', 'AQUA' and 'WATER' each separately and apart from the mark as a whole. AQUA means water. (730) : ALEX MUGUNA RUNGU of P. O. Box 15307- 00400, Tom Mboya, Nairobi, Kenya (740) : None,

### AquaDel Spring Water

---

**(210)** : 137307 **(220)** : 16/01/2025 **(300)** : None **(511)** : 35(Holding company services, namely, providing business management, business administration, business promotion, and business consulting services for subsidiary companies and affiliates.) **(526)** : Registration of this mark shall give no right to the exclusive use of the Words 'CONTINENTAL' and 'GROUP' each separately and apart from the mark as a whole. "JANUS" is a Latin Originated word that refers to the mythical Roman god named Janus and has no direct meaning in English. **(730)** : JCG HOLDINGS LTD of Suite 308, St James Court, St Denis Street, Port Louis, Mauritius **(740)** : Kieti Law LLP of P. O. Box 22602 - 00505, Nairobi, Kenya

## JANUS CONTINENTAL GROUP

---

**(210)** : 137308 **(220)** : 16/01/2025 **(300)** : None **(511)** : 36(Provision of investment capital, financial reporting and financial advising to subsidiary companies and affiliates) **(526)** : CONTINENTALRegistration of this mark shall give no right to the exclusive use of the the the words "CONTINENTAL" and "GROUP" each separately and apart from the mark as a whole. "JANUS" is a Latin Originated word that refers to the mythical Roman god named Janus and has no direct meaning in English. **(730)** : JCG HOLDINGS LTD of Suite 308, St James Court, St Denis Street, Port Louis, Mauritius **(740)** : Kieti Law LLP of P. O. Box 22602 - 00505, Nairobi, Kenya

## JANUS CONTINENTAL GROUP

---

**(210)** : 137309 **(220)** : 16/01/2025 **(300)** : None **(511)** : 35(Holding company services, namely, providing business management, business administration, business promotion, and business consulting services for subsidiary companies and affiliates.) **(526)** : CRegistration of this mark shall give no right to the exclusive use of the the letters "C", "G", "J", the words "CONTINENTAL" and "GROUP" each separately and apart from the mark as a whole. "JANUS" is a Latin Originated word that refers to the mythical Roman god named JANUS and has no direct meaning in English. **(730)** : JCG HOLDINGS LTD of Suite 308, St James Court, St Denis Street, Port Louis , Mauritius **(740)** : Kieti Law LLP of P. O. Box 22602 - 00505, Nairobi, Kenya



---

**(210)** : 137310 **(220)** : 16/01/2025 **(300)** : None **(511)** : 36(Provision of investment capital, financial reporting and financial advising to subsidiary companies and affiliates) **(526)** : CRegistration of this mark shall give no right to the exclusive use of the letters "C", "G", "J", the words "CONTINENTAL" and "GROUP" each separately and apart from the mark as a whole. each separately and apart from the mark as a whole. "JANUS" is a Latin Originated word that refers to the mythical Roman god named Janus and has no direct meaning in English. **(730)** : JCG HOLDINGS LTD of Suite 308, St James Court, St Denis Street, Port Louis , Mauritius **(740)** : Kieti Law LLP of P. O. Box 22602 - 00505, Nairobi, Kenya



---

**(210)** : 137311 **(220)** : 16/01/2025 **(300)** : None **(511)** : 35(Holding company services, namely, providing business management, business administration, business promotion, and business consulting services for subsidiary companies and affiliates.) **(526)** : CRegistration of this mark shall give no right to the exclusive use of the the letters "C", "G", "J", the words "CONTINENTAL" and "GROUP" each separately and apart from the mark as a whole. each separately and apart from the mark as a whole. "JANUS" is a Latin Originated word that refers to the mythical Roman god named Janus and has no direct meaning in English. **(730)** : JCG HOLDINGS LTD of Suite 308, St James Court, St Denis Street, Port Louis , Mauritius **(740)** : Kieti Law LLP of P. O. Box 22602 - 00505, Nairobi, Kenya



**(210)** : 137312 **(220)** : 16/01/2025 **(300)** : None **(511)** : 36(Pending Provision of investment capital, financial reporting and financial advising to subsidiary companies and affiliates ) **(526)** : Registration (of this mark shall give no right to the exclusive use of the the letters "C", "G", "J", the words "CONTINENTAL" and "GROUP" each separately and apart from the mark as a whole. "JANUS" is a Latin originated word that refers to the mythical Roman god named Janus and has no direct meaning in English. **(730)** : JCG HOLDINGS LTD of Suite 308, St James Court, St Denis Street, Port Louis , Mauritius **(740)** : Kieti Law LLP of P. O. Box 22602 - 00505, Nairobi, Kenya



**(210)** : 137421 **(220)** : 21/01/2025 **(300)** : No. 97052521 dated 29/09/2021 in the United States of America **(511)** : 41(Providing online information and materials, namely, articles featuring and dealing with inspirational and motivational stories and topics, mental and emotional challenges experienced by professionals and their families, and the helpfulness of working with a personal mentor, all via the internet; providing online information and materials directed to helping individuals connect with personal mentors to aid with personal development, character development, spiritual development, mental health, emotional health, and strengthening personal relationships via the internet; providing online information and materials directed to helping individuals connect with personal mentors to aid with coping through mental, spiritual and emotional health hardships via the internet) and 45(Providing information in the field of coping with the mental, spiritual, and emotional health challenges that individuals experience in their personal lives, professional lives, and relationships, all via a website) **(526)** : Registration of this mark shall give no right to the exclusive use of the words 'ISSUES' and 'LAWYERS' each separately and apart from the mark as a whole. **(730)** : CAMPUS CRUSADE FOR CHRIST, INC of 100 Lake Hart Drive, 3500, Orlando, Florida 32832, United States of America **(740)** : Iseme, Kamau & Maema Advocates of P. O. Box 11866 - 00400, Nairobi, Kenya

## ISSUES LAWYERS FACE

**(210)** : 137730 **(220)** : 07/02/2025 **(300)** : None **(511)** : 9(Automotive monitoring system, safety system), 11(Solar systems, New energy, Solar Lights.) and 12(Automotive parts) **(526)** : None 'FRISEKER' is a coined word with no specific meaning in English. **(730)** : STARWIN AFRICAN TECHNOLOGY CO. LTD of P. O. Box 31915 - 00600, Nairobi, Kenya **(740)** : None,

FRISEKER

**(210)** : 137992 **(220)** : 24/02/2025 **(300)** : None **(511)** : 9(Batteries for electric vehicles; galvanic cells; galvanic batteries; batteries, electric; battery boxes; battery jars; mobile power supply [rechargeable batteries]; accumulators, electric; chargers for electric accumulators; accumulator boxes; accumulator jars; batteries, electric, for vehicles; microcontrollers; power controllers; Battery chargers; charging stations for electric vehicles; helmets for motorcyclists; bicycle helmets; skateboarding helmets; visors for helmets; protective helmets; sports glasses; sunglasses; electronic key fobs being remote control apparatus.) and 12(Electric vehicles; motorcycles; cars; bicycles; electric bicycles; Electric tricycle; tyres for vehicle wheels; anti-theft devices for vehicles; horns for vehicles; bicycle frames; Electric motorcycle; forklift trucks; bicycle saddles ; self-balancing one-wheeled electric scooters; self-balancing two-wheeled electric scooters; one-wheeled self-balancing scooters self-balancing electric scooters; self-balancing scooters; safety seats for children, for vehicles; push scooters [vehicles]; pumps for bicycle tyres; frames for two-wheeled motor vehicles; bodies for vehicles; folding electric



bicycles; Electric scooter [vehicle]; Electric scooter [electnc vehicle]; electrically powered scooters [vehicles]; motorised scooters [vehicles]; child restralnnts for vehicle seats; child safety harnesses for vehicle seats; mopeds; baskets adapted for bicycles; drinking cup holders adapted for cars; Umbrella holders specially adapted for cars; cup holders for vehicles; roof-mounted luggage racks for vehicles; non-skid devices for vehicle tyres; windscreens; electric cars; Plug-In Electric Vehicle; mobility scooters; fuel cell electric cars; rearvlew mirrors; child booster cushions for vehicle seats; anti-skid chalnns; Antiskid chains for vehicle tires; backrests adapted for use In vehicles; rack trunk bags for motorcycles; pet carriers adapted for bicycles; rack trunk bags for bicycles; motors for land vehicles; driving motors for land vehicles; motors for automobiles; motorcycle engines; hoods for vehicle engines; englnes for automobiles; vehicle bonnet pins; clutches for land vehicles; engines for land vehicles; motors, electric, for land vehicles; steering wheel covers for automobiles; handlebar grips for motorcycles; motorcycle handlebars; saddle covers for motorcycles; bicycle handlebars; saddle covers for bicycles; handlebar grips for bicycles; vehicles fitted seat covers for vehicles; upholstery for) (526) : Registration of this mark shall give no right to the exclusive use of the letter 'A' per se, separately and apart from the mark as a whole.(730) : AIMA TECHNOLOGY GROUP CO., LTD Incorporated in The People's Republic of China of No. 5 Aima Road, South Zone of Jinghai Economic Development Zone Tianjin, China (740) : CFL Advocates of P. O. Box 23555 - 00100, Nairobi, Kenya

(210) : 138042 (220) : 26/02/2025 (300) : None (511) : 9(Chips(integrated circuits); multiprocessor chips; integrated circuit chips for television sets; integrated circuits, integrated circuit chips and integrated circuit modules for digital video compression and decompression; integrated circuits, integrated circuits chips and integrated circuit modules for encoding and decoding digital video; high definition graphic chipsets) (526) : Registration of this mark shall give no right to the exclusive use of the word 'PROCESSOR', the acronym 'AI', the letters 'G' and 'L' each separately and apart from the mark as a whole. (730) : LG CORP. of 128, Yeoui-daero, Yeongdeungpo-gu, Seoul, Republic of Korea (740) : Ndungu Njoroge & Kwach Advocates of P. O. Box 41546 - 00100, Nairobi, Kenya

LG AI Processor

210) : 138232 (220) : 07/03/2025 (300) : None (511) : 29(Meat, fish, poultry and game; meat extracts; preserved, frozen, dried and cooked fruits and vegetables, eggs; milk and products; edible oils and fats.), 30(Coffee, tea, cocoa, sugar, rice, tapioca, sago, artificial coffee, flour and preparations made from cereals, bread, pastry and confectionery (, ices, treacle; yeast, baking-powder; salt, mustard; vinegar, sauces(condiments); spices; ice) and 43(Hotels and restaurants.) (526) : None (730) : TAMARIND MANAGEMENT LIMITED of P. O. Box 74493 - 00200, Nairobi, Kenya (740) : Raffman Dhanji Elms & Virdee LLP of P. O. Box 10719 - 00100, Nairobi, Kenya



(210) : 138306 (220) : 12/03/2025 (300) : None (511) : 3(Fabric softeners for laundry use; laundry bleaches; laundry glaze; laundry preparations; laundry detergents; dishwashing detergents; detergents for household use, detergents for kitchen use; window cleaners; bathroom cleaners; toilet bowl detergents; floor cleaners; cleaning waste pipes (preparations for-); bleaching preparations for domestic use; wet wipes; cleaning wipes; cleaning wipes impregnated with a cleaning agent; stain removers; soaps; hand soaps; dentifrices; skin creams.) (526) : None The Thai characters in the trademark translate into English as "LIPON F". The phrase "Lipon F" is a coined phrase and

ลิปอน ฟ

---

has no meaning. (730) : LION CORPORATION of 1-3-28 Kuramae, Taitoku, Tokyo 111-8644, Japan (740) : Ndungu Njoroge & Kwach Advocates of P. O. Box 41546 - 00100, Nairobi, Kenya

---

**CIMEGRA**

(210) : 138464 (220) : 19/03/2025 (300) : None (511) : 5(Preparations for destroying and combating vermin; insecticides, fungicides for agricultural use, herbicides, pesticides) (526) : None (730) : BASF Agrochemical Products B.V. of Velperplein 23, Arnhem, Netherlands (740) : Kaplan & Stratton Advocates of P. O. Box 40111 - 00100, Nairobi, Kenya

---

**ROOTMATE "POWER  
YOUR ROOTS. PROSPER  
YOUR CROPS"**

(210) : 138508 (220) : 21/03/2025 (300) : None (511) : 1(Fertilizer, foliar feed, plant supplement) (526) : Registration of this mark shall give no right to the exclusive use of the words 'ROOT', 'ROOTS', 'POWER' and 'CROPS' each separately and apart from the mark as a whole. (730) : GROWMATE KENYA LTD of P. O. Box 18440 - 00100, Nairobi, Kenya (740) : None,

---

**IRIE POT**

(210) : 138514 (220) : 21/03/2025 (300) : None (511) : 16(Advertising signs of cardboard (in the lottery industry); advertising signs of paper (in the lottery industry); calendars and diaries (in the lottery industry); printed products, namely, product guides featuring (the lottery industry); printed pamphlets, brochures, manuals, books, booklets, leaflets, informational flyers, informational sheets and newsletters, adhesive backed stickers, and kits comprised solely of one or more of the foregoing materials in the field of lottery), 25(Clothing namely, dress shirts, collared shirts, t-shirts, polo shirts), 28(Games and playthings related to lottery type games; gaming machines featuring a device that accepts wagers; gaming machines for gambling; gaming machines that generate or display wager outcomes; gaming machines, namely, devices which accept a wager; amusement game machines; lottery tickets) and 41(Providing of training and entertainment related to lottery type games; administration of lotteries for others; betting services; lottery services; operating lotteries; operating of lotteries; organization of lotteries; conducting lotteries for others; on-line lottery services) (526) : None (730) : SUPREME VENTURES GAMING LIMITED A Jamaican company of 9A Retirement Crescent, Kingston 5, St. Andrew, Jamaica (740) : Coulson Harney LLP of P. O. Box 10643 - 00100, Nairobi, Kenya

---

**JAGDISH**

(210) : 138630 (220) : 27/03/2025 (300) : None (511) : 7(Chaff cutters, sugar cane crushers) (526) : None (730) : RAM TECH SUPPLIES LIMITED of P. O. Box 18336 - 00500, Nairobi, Kenya (740) : None,

---

**MOTO BELL F1**

(210) : 138726 (220) : 02/04/2025 (300) : None (511) : 31(Seeds, fresh fruits and vegetables, maize) (526) : Registration of this mark shall give no right to the exclusive use of the letter 'F' and the numerical '1' each separately and apart from the mark as a whole. 'MOTO' is a Swahili word meaning 'FIRE' in English. (730) : UNITED SEEDS LTD of P. O. Box 49830, GPO, Nairobi, Kenya (740) : None,

---

**MAJI STAR F1**



(210) : 138728 (220) : 02/04/2025 (300) : None (511) : 31(Seeds, fresh fruits and vegetables, maize) (526) : STARRegistration of this mark shall give no right to the exclusive use of the word "STAR", the letter 'F' and the numeral '1' each separately and apart from the mark as a whole 'MAJI' is a Swahili word meaning 'Water' in English. (730) : UNITED SEEDS LTD of P. O. Box 49830, GPO, Nairobi, Kenya (740) : None,

---

**SIMBA SCORCH F1**

(210) : 138731 (220) : 02/04/2025 (300) : None (511) : 31(Seeds, fresh fruits and vegetables, maize) (526) : Registration of this mark shall give no right to the exclusive use of the letter 'F' and the numeral '1' each separately and apart from the mark as a whole. 'SIMBA' is a Swahili word meaning 'Lion' in English. (730) : UNITED SEEDS LTD of P. O. Box 49830, GPO, Nairobi, Kenya (740) : None,

---

<p>(210) : 138735 (220) : 02/04/2025 (300) : None (511) : 31(Seeds, fresh fruits and vegetables, maize) (526) : FIRERegistration of this mark shall give no right to the exclusive use of the word "FIRE", the letter 'F' and the numeral '1' each separately and apart from the mark as a whole 'MOTO' is a Swahili word meaning 'Fire' in English. (730) : UNITED SEEDS LTD of P. O. Box 49830, GPO, Nairobi, Kenya (740) : None,</p>	<b>MOTO FIRE F1</b>
<p>(210) : 138740 (220) : 02/04/2025 (300) : None (511) : 31(Seeds, fresh fruits and vegetables, maize) (526) : GOLDRegistration of this mark shall give no right to the exclusive use of the word "GOLD", the letter 'F' and the numeral '1' each separately and apart from the mark as a whole 'CHUMA' is a Swahili word meaning 'METAL' in English. (730) : UNITED SEEDS LTD of P. O. Box 49830, GPO, Nairobi, Kenya (740) : None,</p>	<b>CHUMA GOLD F1</b>
<p>(210) : 138745 (220) : 02/04/2025 (300) : None (511) : 31(Seeds, fresh fruits and vegetables, maize) (526) : REDRegistration of this mark shall give no right to the exclusive use of the word "RED", the letter 'F' and the numeral '1' each separately and apart from the mark as a whole 'DHAHABU' is a Swahili word meaning 'GOLD' in English. (730) : UNITED SEEDS LTD of P. O. Box 49830, GPO, Nairobi, Kenya (740) : None,</p>	<b>DHAHABU RED F1</b>
<p>(210) : 138746 (220) : 02/04/2025 (300) : None (511) : 31(Seeds, fresh fruits and vegetables, maize) (526) : Registration of this mark shall give no right to the exclusive use of the letter 'F' and the numeral '1' each separately and apart from the mark as a whole. (730) : UNITED SEEDS LTD of P. O. Box 49830, GPO, Nairobi, Kenya (740) : None,</p>	<b>AFRIROMA F1</b>
<p>(210) : 138748 (220) : 02/04/2025 (300) : None (511) : 31(Seeds, fresh fruits and vegetables, maize) (526) : Registration of this mark shall give no right to the exclusive use of the words 'KIJANI PRIME', the letter 'F' and the numeral '1' each separately and apart from the mark as a whole. 'KIJANI' is a Swahili word meaning 'Green' in English. (730) : UNITED SEEDS LTD of P. O. Box 49830, GPO, Nairobi, Kenya (740) : None,</p>	<b>KIJANI PRIME F1</b>
<p>(210) : 138812 (220) : 07/04/2025 (300) : None (511) : 31(Seeds, vegetables, fruits, maize/bean) (526) : Registration of this mark shall give no right to the exclusive use of the words 'MAVUNO', 'PRIME', the letter 'F' and the numeral '1' each separately and apart from the mark as a whole. 'MAVUNO' is a Swahili word meaning 'Harvest' in English. (730) : UNITED SEEDS LTD of P. O. Box 49830, GPO, Nairobi, Kenya (740) : None,</p>	<b>MAVUNO PRIME F1</b>
<p>(210) : 138815 (220) : 07/04/2025 (300) : None (511) : 31(Seeds, fresh fruits and vegetables, Maize) (526) : Registration of this mark shall give no right to the exclusive use of the word 'CRUNCH', the letter 'F' and the numeral '1' each separately and apart from the mark as a whole. 'UHURU' is a Swahili word meaning 'Freedom' in English. (730) : UNITED SEEDS LTD of P. O. Box 49830, GPO, Nairobi, Kenya (740) : None,</p>	<b>Uhuru Crunch F1</b>
<p>(210) : 138910 (220) : 10/04/2025 (300) : None (511) : 3(Non-medicated toiletry preparations, cleaning preparations for use in home and other environments) (526) : Registration of this mark shall give no right to the exclusive use of the words 'FAMILY', 'BATHING' and 'SOAP' each separately and apart from the mark as a whole. 'MILELE' is a Swahili word meaning 'FOREVER' in English. (730) : BIDCO AFRICA LIMITED of P. O. Box 239 - 01000, General Kago Road, Thika, Kenya (740) : None,</p>	
<p>(210) : 138911 (220) : 10/04/2025 (300) : None (511) : 29(Oils and fats for food; edible fats) (526) : Registration of this mark shall give no right to the exclusive use of the word 'FRY' separately and apart from the mark as a whole. 'JOMA' is a coined word and has no specific meaning in English. (730) : BIDCO AFRICA LIMITED of P. O. Box 239 - 01000, General Kago Road, Thika, Kenya (740) : None,</p>	

**(210)** : 139023 **(220)** : 16/04/2025 **(300)** : None **(511)** : 1(Fertilizer, foliar feed, plant supplement) **(526)** : Registration of this mark shall give no right to the exclusive use of the prefix 'AGRI' separately and apart from the mark as a whole. **(730)** : GROWMATE KENYA LTD of P. O. Box 18440 - 00100, Nairobi, Kenya **(740)** : None,

## AGRINOBLE AEGIS

**(210)** : 139101 **(220)** : 22/04/2025 **(300)** : None **(511)** : 32(Beers, mineral and aerated waters and other non-alcoholic beverages and fruit juices; syrups and other preparations for making beverages) and 40(Brewing services, distillery services) **(526)** : Registration of this mark shall give no right to the exclusive use of the word 'BREWHOUSE' separately and apart from the mark as a whole. **(730)** : EAST AFRICAN BREWERIES PLC of P. O. Box 30161 - 00100, Garden City Business Park, Block A, 5th Floor Nairobi, Kenya **(740)** : Coulson Harney LLP of P. O. Box 10643 - 00100, Nairobi, Kenya



**(210)** : 139104 **(220)** : 22/04/2025 **(300)** : None **(511)** : 9(Scientific, nautical, surveying, photographic, cinematographic, optical, weighing, measuring, signaling, checking (supervision), life-saving and teaching apparatus and instruments; electric and electronic apparatus and hardware, equipment for the storage and transmission of data and information for use in relation to banking, financial, insurance and general commercial transactions, including those conducted online via the Internet or a computer network, or by telephone or cellular telephone; software, systems, devices and platforms used to enable and facilitate electronic banking, financial, insurance or other commercial transactions, including those via the Internet or a computer network, or by telephone or cellular telephone; including data processing equipment and software for use in relation to banking and financial services including data processing equipment and software; downloadable electronic publications; apparatus and equipment for the electronic transfer of and/or financial data; telecommunication equipment; automated teller machines; money dispensing machines, electronic fund transfer, payment or point of sale apparatus, machines and terminals; card and bar code scanners; magnetic and magnetically encoded cards; programmable cards; smart cards; cards bearing coded data in magnetic form; cards bearing data for use in computers; cards bearing coded data in punched-out form; cards bearing data for use in dataprocessing apparatus; cards bearing data for use in data storage apparatus; cards bearing electronically recorded data; cards bearing integrated circuits; cards bearing magnetic or encoded data for input; cards bearing micro-chips and computer cards containing chips; credit, charge, debit and/or cash cards ; prepayment cards [encoded]; loyalty or gift cards [encoded], readers, scanners, parts and fittings for the aforementioned goods), 16(Paper, cardboard and goods made from these materials, not included in other classes; printed matter; books, magazines, manuals newspapers, newsletters, pamphlets; bookbinding material; photographs; stationery; adhesives for stationery or household, purposes; artists' materials; paint brushes; typewriters, office requisites (except furniture); instructional and teaching materials (except apparatus); wrapping and packaging materials; plastic materials for packaging (not included in other classes); printers' type; printing blocks; printed publications; newsletters, reviews and publications; documentation relating to financial, banking, insurance and investment services or transactions; advertising materials ; brochures, vouchers, cheques, cheque books; cheque book holders; paying-in books; bank cards, cash cards, cheque cards, debit cards , credit cards, charge cards, loyalty or gift cards all being other than encoded or magnetic cards.), 35(Advertising; business management;



---

business administration; office functions; facilitation of commercial and business transactions, including those conducted online via the Internet or a computer network, or by telephone or cellular telephone; business strategy services; business appraisal and analysis services database management services; provision of business and commercial; advice and information provided by telephone or provided online from a computer database, computer network, global computer network or the Internet; business planning; business strategy services, business appraisals; business management assistance; business support; accounting; economic forecasting and analysis for business purposes; profit and cash flow forecasting, analysis and planning, all being economic forecasting services; personnel management and employment consultancy; database management services, data processing, data verification and file management; computerised business information storage and retrieval; credit card registration services; procurement of goods and services on behalf of businesses; purchasing of goods and services for other businesses; business administration services for the processing of sales and transactions made on a global computer network or the Internet; the bringing together, for the benefit of others, of a variety of goods including but not limited to, business equipment, enabling customers to conveniently view and purchase those goods from a computer network website or an Internet website; offering for sale and the sale of goods in the retail and wholesale trade; customer loyalty reward schemes, customer care services; advisory, consultancy, information and helpline services relating to all of the aforesaid services ancillary or related to the aforementioned all in class 35.), 36(Insurance products and services; financial affairs; monetary affairs; real estate affairs; banking services; payment facilitation services, facilitation and rendering of banking and financial transactions, including those rendered online via the Internet or computer network , or by telephone or cellular telephone; services ancillary and related to all of the foregoing, all in class 36.), 38(Telecommunications and communications services; providing user access to computer networks or the Internet for purposes of facilitating commercial, banking or financial transactions and electronic payments; providing telecommunications connections to the Internet or data bases for purposes of facilitating commercial, banking or financial transactions and electronic payments services ancillary and related to all of the foregoing, all in class 38.), 41(Education; providing of training; entertainment; sporting and cultural activities; television entertainment; organising and conducting of competitions; publication of printed matter, services ancillary and related to all of the foregoing, all in class 41.) and 42(Scientific and technological services and research and design relating thereto; industrial analysis and research services; IT services, design and development of computer hardware and software and computer systems; operation of websites and online transactional platforms; rental of computer hardware and software; leasing of access time to computer database; advisory, information, evaluations, consultancy services; services ancillary and related to all of the foregoing, all in class 42. ) (526) : None (730) : THE STANDARD BANK OF SOUTH AFRICA LIMITED Incorporated in South Africa of 5 Simmonds Street, Johannesburg, 2001, Gauteng, South Africa (740) : Coulson Harney LLP of P. O. Box 10643 - 00100, Nairobi, Kenya

---

(210) : 139110 (220) : 23/04/2025 (300) : None (511) : 31(Seeds, vegetables, fruits, maize/bean) (526) : Registration of this mark shall give no right to the exclusive use of the word 'STAR', the letter 'F' and the numeral '1' each separately and apart from the mark as a whole. 'KIDUNDU' is a Swahili word meaning 'Ball' in English. (730) : UNITED SEEDS LTD of P. O. Box 49830 - 00100, GPO, Nairobi, Kenya (740) : None,

### KIDUNDU STAR F1

(210) : 139111 (220) : 23/04/2025 (300) : None (511) : 31(Seeds, vegetables, fruits, maize/bean) (526) : Registration of this mark shall give no right to the exclusive use of the letter 'F' and the numeral '1' each separately and apart from the mark as a whole. 'MAJI BORA' is a Swahili word meaning 'BEST WATER' in English. (730) : UNITED SEEDS LTD of P. O. Box 49830 - 00100, GPO, Nairobi, Kenya (740) : None,

### MAJI BORA F1

(210) : 139113 (220) : 23/04/2025 (300) : None (511) : 31(Seeds, vegetables, fruits, maize/ bean) (526) : Registration of this mark shall give no right to the exclusive use of the letter 'F' and the numeral '1' each separately and apart from the mark as a whole. 'MAVUNO JUA' is a Swahili word meaning 'Sun Harvest' in English. (730) : UNITED SEEDS LTD of P. O. Box 49830 - 00100, GPO, Nairobi, Kenya (740) : None,

### MAVUNO JUA F1

(210) : 139115 (220) : 23/04/2025 (300) : None (511) : 31(Seeds, vegetables, fruits, maize/ bean) (526) : Registration of this mark shall give no right to the exclusive use of the word 'RED', the letter 'F' and the numeral '1' each separately and apart from the mark as a whole. 'MSHINDI' is a Swahili word meaning 'Winner' in English. (730) : UNITED SEEDS LTD of P. O. Box 49830 - 00100, GPO, Nairobi, Kenya (740) : None,

### MSHINDI RED F1

(210) : 139269 (220) : 29/04/2025 (300) : None (511) : 31(Seeds, Vegetable, Fruits, Maize/bean) (526) : Registration of this mark shall give no right to the exclusive use of the word 'KUNDE', the letter 'F' and the numerical '1' each separately and apart from the mark as a whole. 'KUNDE' is a Swahili word meaning 'Cowpea' in English. 'IMARA' is a Swahili word meaning 'Strong' in English. (730) : UNITED SEEDS LTD of P. O. Box 49830 - 00100, GPO, Nairobi, Kenya (740) : None,

### Kunde Imara F1

(210) : 139271 (220) : 29/04/2025 (300) : None (511) : 31(Seeds, fruits and vegetables, Maize/bean) (526) : Registration of this mark shall give no right to the exclusive use of the word 'MBEGU', the letter 'F' and the numeral '1' each separately and apart from the mark as a whole. 'MBEGU' is a Swahili word meaning 'Seed" in English. 'MAMBA' is a Swahili word meaning 'Crocodile' in English. (730) : United Seeds Ltd of P.O. BOX 49830-00100 GPO, Nairobi, Kenya (740) : None,

### Mbegu Mamba F1

(210) : 139275 (220) : 29/04/2025 (300) : None (511) : 24(Fabrics and fabrics covers for household use and includes bedspreads, pillow shams, towels of textile, sleeping bags and sleeping bag liners.) (526) : AMANIRegistration of this mark shall give no right to the exclusive use of the word "AMANI" and the device of the "MAP OF AFRICA" each separately and apart from the mark as a whole "AMANI" is a Swahili word that translate to "Peace" in English (730) : PENGSHENG INDUSTRIAL DEVELOPMENT COMPANY LIMITED of P. O. Box 19486 - 00100, Nairobi, Kenya (740) : None,



(210) : 139301 (220) : 30/04/2025 (300) : None (511) : 9(Mobile phones) (526) : DRegistration of this mark shall give no right to the exclusive use of the letters "D" and "H" each separately and apart from the mark as a whole (730) : HOLDEN LOGISTICS COMPANY LTD of P. O. Box 104021 -00101, Nairobi, Kenya (740) : None,



**(210)** : 139409 **(220)** : 07/05/2025 **(300)** : No. UK00004121975 dated 07/11/2024 in the United Kingdom. **(511)** : 7(Machines for glass working; machinery for shaping glass; machines for glass making; molding machines; molds for use in the manufacture ; bottling machines; bottle capping machinery; bottle capping machines; bottle capping machines for food and beverages; bottle filling machines; bottle sealing machines; bottle capping machines; coating machines ; continuous casting machines.), 11(Furnaces; industrial furnaces; low-carbon furnaces; furnaces that incorporate low carbon technology; electric furnaces; electric furnaces for industrial purposes; melting furnaces; furnaces for glass making; glass melting furnace; glass bending furnace; hybrid furnace; hybrid melting furnace; furnaces that incorporate hybrid melting technology; electric furnace; heating furnaces for industrial purposes; heating furnaces for industrial use; heating apparatus for furnaces; furnaces for industrial use), 16(Wrapping and packaging materials; paper and paper articles; cardboard and cardboard articles and printed matter.), 21(Glass and glass products; containers, articles made of glass; articles of glassware; articles of glass for household and kitchen use; coloured glass; crude glass; drinking glasses; semi-worked glass; glass receptacles; glass bottles, glass caps, glass jars; glass powder; moulded lass; rough glass; semi-finished lass; unprocessed glass),40(Material treatment of glass; decorating and colouring of glass; colouring of glass by surface treatment; application of coatings to glass; application of protective coatings to glass; bevelling of glass; glass blowing; glass polishing; glass etching; glass resurfacing glass tempering ,glass tinting) and 42(Development of new furnace technology; development of low-carbon technology in the context of glassmaking; development of low-carbon technology in the context of glass and metal packaging; Design of low-carbon technology in the context of glassmaking; Design of low-carbon technology in the context of industrial furnaces; Technical consultancy relating to electrical furnace technology; Technical consultancy relating to hybrid furnace technology; Research relating to low-carbon furnace technology; Research relating to electrical furnace technology; Research relating to hybrid furnace technology; Design of glass and of glass products; quality control of glass containers; research, design and development of glass and of glass products; technical services relating to glass packaging.) **(526)** : None **(730)** : ARDAGH PACKAGING INTERNATIONAL SERVICES LIMITED of Ardagh House, South County Business Park, Leopardstown, Dublin 18, Ireland **(740)** : Iseme, Kamau & Maema Advocates of P. O Box 11866 - 00400, Nairobi, Kenya



**(210)** : 139573 **(220)** : 14/05/2025 **(300)** : None **(511)** : 3(Bleaching preparations and other substances for laundry use) **(526)** : None **(730)** : BLUE RING PRODUCTS LTD of P. O. Box 56337 - 00200, Nairobi, Kenya **(740)** : None,

**BYTEX**

**(210)** : 139574 **(220)** : 14/05/2025 **(300)** : None **(511)** : 40(Treatment of materials; recycling of waste and trash) **(526)** : None 'SANPIT' is a coined word with no meaning. **(730)** : BLUE RING PRODUCTS LTD of P. O. Box 56337-00200, Nairobi, Kenya **(740)** : None,

**SANPIT**

**(210)** : 139575 **(220)** : 14/05/2025 **(300)** : None **(511)** : 3(Cleaning, polishing, scouring and abrasive preparations.) **(526)** : None **(730)** : BLUE RING PRODUCTS LTD of P. O. Box 56337 - 00200, Nairobi, Kenya **(740)** : None,

**OTO**

**(210)** : 139786 **(220)** : 23/05/2025 **(300)** : None **(511)** : 7(Lawnmowers [machines]; disintegrators; mixers [machines]; driving motors other than for land vehicles; blowing machines; pumps [machines]; compressed air pumps; compressed air machines; pumps [parts of machines, engines or motors]; welding machines, electric) **(526)** : None  
 The trade mark consists of the stylized wording "TPON". The wording "TPON" has no significance in the relevant trade or industry or as applied to the goods/services listed in the application, no geographical significance, not a term of art, nor any meaning in any foreign language. **(730)** : NINGBO GUANGHAN PUMP CO., LTD A limited company organized and existing under the laws of China of Heyi Village, JiangshanTown, Yinzhou District, Ningbo City, Zhejiang Province, China (Room 1-1, Building 6#, Yingong Intelligent Manufacturing Industrial Park), China **(740)** : Simba & Simba Advocates of P. O. Box 10312 - 00100, Nairobi, Kenya



**(210)** : 139805 **(220)** : 23/05/2025 **(300)** : None **(511)** : 36(Financial, monetary and banking services; insurance services; real estate services) **(526)** : Registration of this mark shall give no right to the exclusive use of the word 'MONEY' and the dollar symbol '\$' each separately and apart from the mark as a whole. **(730)** : THOMAS MUTHANGYA MUSYOKA of P. O. Box 1093 - 00606, Nairobi, Kenya **(740)** : None,



**(210)** : 139836 **(220)** : 26/05/2025 **(300)** : None **(511)** : 6(Common metals and their alloys; pre-engineered and prefabricated metal buildings; metal building materials; including metal roofing materials, metallic roof sheeting, cladding and accessories including metallic ridge capping, rolltop ridging, drip and sidewall flashing, gutters, downpipes, bargeboards, ventilators and louvres) **(526)** : Registration of this mark shall give no right to the exclusive use of the word'HOMES' separately and apart from the mark as a whole. **(730)** : SAFAL INVESTMENTS (MAURITIUS) LIMITED of 6th Floor, Two Tribeca, Tribeca Central, Trianon, 72261, Mauritius **(740)** : CFL Advocates of P. O. Box 23555 - 00100, Nairobi, Kenya



**(210)** : 139916 **(220)** : 29/05/2025 **(300)** : None **(511)** : 32(Water and beverages) **(526)** : Registration of this mark shall give no right to the exclusive use of the device of a 'WATER DROP' separately and apart from the mark as a whole. The English translation of the Swahili word "DHAHABU" is "Gold". **(730)** : CICILY LIMITED of P. O. Box 17987 - 00500, Nairobi, Kenya **(740)** : None,



**(210)** : 139926 **(220)** : 30/05/2025 **(300)** : None **(511)** : 1(Glue for industrial purposes) **(526)** : FIXRegistration of this mark shall give no right to the exclusive use of the word "FIX" and the device of the "HIPPO" each separately and apart from the mark as a whole. **(730)** : DINGLI (KENYA) INDUSTRIAL CO. LIMITED of P. O. Box 3174 - 00100, Nairobi, Kenya **(740)** : None,



**(210)** : 139965 **(220)** : 03/06/2025 **(300)** : None **(511)** : 6(Cement) **(526)** : KRegistration of this mark shall give no right to the exclusive use of the word "SAPPHIRE", the letters "K" and "P" each separately and apart from the mark as a whole. **(730)** : MOMBASA CEMENT LIMITED of P. O. Box 83594 -80100, Mombasa, Kenya **(740)** : None,



**(210)** : 140005 **(220)** : 05/06/2025 **(300)** : None **(511)** : 32(Aerated drinking water) **(526)** : Registration of this mark shall give no right to the exclusive use of the words "MOROP" and "SPRING" each separately and apart from the mark as a whole. "MOROP" is a name derived from a mountain in Baringo Central Subcounty, Baringo County. **(730)**



---

: CHRISTOPHER CHESIRE of P. O. Box 311 - 30400, Kabarnet, Kenya  
(740) : None,



---

(210) : 140110 (220) : 11/06/2025 (300) : None (511) : 4(Industrial oil and greases; lubricants; dust absorbing, wetting and binding composition fuel (including motor spirit) and illuminants; candles and wicks for lighting.) (526) : Registration of this mark shall give no right to the exclusive use of the words "RAMOGI", "GAS", the device of a "CYLINDER" and the letter "R" per se each separately and apart from the mark as a whole. (730) : KEPHER ODONGO of P. O. Box 4202 - 00200, Nairobi, Kenya (740) : None,

---

(210) : 140151 (220) : 12/06/2025 (300) : None (511) : 5(Herbicide, fungicides, insecticides) (526) : None (730) : GREENLIFE CROP PROTECTION AFRICA LTD of P. O. Box 24942 - 00100, Nairobi, Kenya (740) : None,

Dismate

---

(210) : 140153 (220) : 12/06/2025 (300) : None (511) : 5(Herbicide, fungicide, insecticides) (526) : None (730) : FIDELITY HEALTHQUARD LTD of P. O. Box 46733 - 00100, Nairobi, Kenya (740) : None,

LOCKME

---

(210) : 140245 (220) : 16/06/2025 (300) : None (511) : 9(Downloadable application software for mobile phones; downloadable software for use as an application programming interface (API); downloadable computer software for management of digital currency trading; downloadable computer software for mining digital currency; downloadable computer software for use as digital currency wallets; downloadable computer software for managing digital asset transactions using blockchain technology; downloadable computer software for use as a digital asset management platform for management, purchase, sale, transfer and payment of digital currency; digital currency (digital data); virtual currency (digital data); cryptocurrency (digital data); stablecoins (digital data); digital tokens (downloadable digital files) used with blockchain technology; electronic currency converter; computer software applications; web-based application software; downloadable e-wallets; internet connecting apparatus; data processing apparatus; computer programs, recorded; computer software recorded quantity indicators; face recognition apparatus; electronic notice boards; electro-dynamic apparatus for the remote control of signals; sound transmitting apparatus; security tokens [encryption devices]; downloadable electronic publications.) and 36(Financial services; financial analysis; financial consultancy; financial services (trading of digital currency , virtual currency, cryptocurrency, stablecoins and digital tokens); electronic funds transfer; electronic funds transfer provided via blockchain technology; money deposit and withdrawal services via electronic means; remittance services; e-wallet payment services; credit card services; debit card services; financial database services relating to credit card transactions, debit card transactions and other payment transactions; financial services relating to credit card customer loyalty and reward programs; digital currency and digital token exchange services; digital currency and digital token trading; processing of digital currency and digital token payments; currency exchange services; exchanging mon.-, online real-time currency trading, financial management via the Internet; providing financial information; capital investment; financing services; loans [financing]; numismatic appraisal; surety services; trusteeship.) (526) : Registration of this mark shall give no right to the exclusive use of the word 'PAY' and the letter 'P' each separately and apart from the mark as a whole. The mark proceeds in series. (730) : RED WISDOM LIMITED of Room 5710, 57/F, The Center, 99 Queen's Road Central, Central , Hong Kong (740) : Ndungu Njoroge & Kwach Advocates of P. O. Box 41546 - 00100, Nairobi, Kenya

---

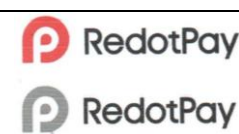

(210) : 140261 (220) : 17/06/2025 (300) : None (511) : 29(Oils and fats for food; edible fats) (526) : Registration of this mark shall give no right to the exclusive use of the words 'AFRICA', 'GOLD', 'PURE', 'SOYA' and the device of a 'MAP OF AFRICA' per se, each separately and apart from the mark as a whole. (730) : BIDCO AFRICA LIMITED of P. O. Box 239 - 01000, General Kago Road, Thika, Kenya (740) : None,



(210) : 140262 (220) : 17/06/2025 (300) : None (511) : 29(Oils and fats for food; Edible fats) (526) : Registration of this mark shall give no right to the exclusive use of the word 'BAKE' and the device of a 'CHEF'S HAT' per se, each separately and apart from the mark as a whole. (730) : BIDCO AFRICA LIMITED of P. O. Box 239 - 01000, General Kago Road, Thika, Kenya (740) : None,



(210) : 140267 (220) : 17/06/2025 (300) : None (511) : 29(Oils and fats for food; edible fats ) (526) : Registration of this mark shall give no right to the exclusive use of the words 'AFRICA', 'GOLD', 'PURE', 'LITE', 'EAT LITE LIVE LIFE' and the device of a 'MAP OF AFRICA' per se, each separately and apart from the mark as a whole. (730) : BIDCO AFRICA LIMITED of P. O. Box 239 - 01000, General Kago Road, Thika, Kenya (740) : None,



(210) : 140269 (220) : 17/06/2025 (300) : None (511) : 5(Pest Control Products-preparations for destroying vermin; fungicides, herbicides) (526) : None (730) : JUANCO GROUP LIMITED Manufacturers, developers and distributors of P. O. Box 381 - 00502, Karen, Nairobi, Kenya (740) : None,

**FOSPREMIA**

(210) : 140353 (220) : 19/06/2025 (300) : None (511) : 7(Mining machines and apparatus; construction machines and apparatus; loading-unloading machines and apparatus; snow ploughs; waste compacting machines and apparatus; waste crushing machines.) and 37(Repair or maintenance of mining machines and apparatus; repair or maintenance of construction machines and apparatus; repair or maintenance of snow ploughs; repair or maintenance of waste compacting machines and apparatus; rental of mining machines and apparatus; rental of construction machines and apparatus.) (526) : Registration of this mark shall give no right to the exclusive use of the words 'DRILL' and 'ROCK' each separately and apart from the mark as a whole. 'FURAKAWA' is a Japanese surname linked to the founder of 'Furakawa Co, Ltd, Ichibei Furakawa and has no meaning in English. (730) : FURUKAWA ROCK DRILL CO., LTD A company organised and existing under the laws of Japan of 6-4, Otemachi 2-chome, Chiyoda-ku Tokyo 100-8370, Japan (740) : Coulson Harney LLP of P. O. Box 10643 - 00100, Nairobi, Kenya

**FURUKAWA ROCK DRILL**

(210) : 140354 (220) : 19/06/2025 (300) : None (511) : 7(Mining machines and apparatus; construction machines and apparatus; loading-unloading machines and apparatus; snow ploughs; waste compacting machines and apparatus; waste crushing machines.) and 37(Repair or maintenance of mining machines and apparatus; repair or maintenance of construction machines and apparatus; repair or maintenance of snow ploughs; repair or maintenance of waste compacting machines and apparatus; rental of mining machines and apparatus; rental of construction machines and apparatus.) (526) : Registration of this mark shall give no right to the exclusive use of the letters 'D', 'F' and 'R' each separately and apart from the mark as a whole. (730) : FURUKAWA ROCK DRILL CO., LTD A company organised and existing under the laws of Japan of 6-4, Otemachi 2-chome, Chiyoda-ku Tokyo 100-8370, Japan (740) : Coulson Harney LLP of P. O. Box 10643 - 00100, Nairobi, Kenya

**FRD**

(210) : 140396 (220) : 23/06/2025 (300) : None (511) : 36(Insurance; financial affairs; monetary affairs; real estate affairs; clearing and reconciling financial transactions via a global computer network; online banking services and financial services; credit card services; processing and transmission of bills and payments thereof, and providing insurance for financial transactions; funds transfer services; transfer of payments for others via the Internet; financial services in the nature of bill payment services and processing services; provision of financial information via the Internet; issuing of travel vouchers services; capital investments; financial evaluation [insurance, banking, real estate]; asset management services; financial consultancy and advisory services; securities brokerage services, stock exchange quotation services; stocks and bonds brokerage, financial analysis; debit card services, charge card services and cheque guarantee services; financial clearing services; credit verification via global computer information network; electronic credit risk management services; electronic purchase payment and electronic bill payment services; issuance of stored value cards, charge cards and debit cards; information services relating to finance and insurance, provided online from a computer database or the Internet; agency for collection of gas and electricity fees; charitable fund raising; online payment services; Issuing of vouchers; provision of electronic funds transfer services; monetary exchange services, provision of prepaid cards and tokens; remittance services and money transfer services; financial transaction services, namely, providing secure payment and remittance transactions; including all of the aforementioned services provided by electronic means; foreign currency transfer services; foreign currency exchange; currency trading; currency dealing; brokerage of currency; financial transactions via blockchain; fundraising and financial sponsorship; brokerage of carbon offsets; financial sponsorship of carbon offset programmes; funding of and investment in emissions reduction projects; investment in emissions reduction funds; provision of loans; providing temporary loans; electronic wallet services (payment services); payment services and transfer of funds by means of payment terminals; financial services, namely, the provision of contactless mobile payments through merchants at retail, online and wholesale locations; financial risk management services; financial transaction analysis, namely, analyzing transactions for payment fraud, illegality and compliance with payment transaction regulations and antifraud and money laundering controls; providing purchase protection services for goods and services purchased by others via a global computer network and wireless networks, namely, providing fraud reimbursement services -in the field of credit card purchases and electronic payment purchases, and providing secure commercial transactions for credit card purchases and electronic payment purchases; reimbursement of funds for disputed items in the field of electronic payment purchases; financial services in relation to and for facilitating the buying, selling, trading and management of digital currency, blockchain tokens, and other digital assets on a trading platform; financial services related to digital wallets and electronic wallets, including secure storage and transaction processing of digital assets; Issuance of tokens of value; redeeming the tokens of value of others for payment of goods or services; financial consultancy services related to blockchain technology, digital assets, smart contracts and the integration of traditional and decentralized financial systems; digital currency, cryptocurrency, stable coin and virtual currency services; digital currency wallet and storage services; custodian electronic wallet services in relation to digital currency, cryptocurrency, stable coin, digital payment tokens and virtual currency; Issuance, transmission and transfer of stable coins and digital

**BETTRCOIN**

payment tokens; financial services relating to customer loyalty, incentive and reward programs; exchange and redemption services in relation to customer loyalty, incentive and reward programs; providing discount card services and other rebate services as part of a customer loyalty program; providing rebates at participating establishments of others through use of a membership card; consultancy, information and advisory services relating to the aforesaid services.) **(526)** : Registration of this mark shall give no right to the exclusive use of the word 'COIN' separately and apart from the mark as a whole. **(730)** : ADVANCED NOVA TECHNOLOGIES (SINGAPORE) HOLDING PTE. LTD of 128 Beach Road #20-01, Guoco Midtown Office 189773, Singapore **(740)** : CFL Advocates of P. O. Box 23555 - 00100, Nairobi, Kenya

**(210)** : 140398 **(220)** : 23/06/2025 **(300)** : None **(511)** : 36 (Insurance; financial affairs; monetary affairs; real estate affairs; clearing and reconciling financial transactions via a global computer network; online banking services and financial services; credit card services; processing and transmission of bills and payments thereof, and providing insurance for financial transactions; funds transfer services; transfer of payments for others via the internet; financial services in the nature of bill payment services and processing services; provision of financial information via the Internet; issuing of travel vouchers services; capital investments; financial evaluation [insurance, banking, real estate ]; asset management services; financial consultancy and advisory services; securities brokerage services, stock exchange quotation services; stocks and bonds brokerage, financial analysis; debit card services, charge card services and cheque guarantee services; financial clearing services; credit verification via global computer information network; mm 05626G9 & 9NDGDDO electronic credit risk management services; electronic purchase payment and electronic bill payment services; issuance of stored value cards, charge cards and debit cards; information services relating to finance and insurance, provided online from a computer database or the Internet; agency for collection of gas and electricity fees; charitable fund raising; online payment services ; issuing of vouchers; provision of electronic funds transfer services; monetary exchange services, provision of prepaid cards and tokens; remittance services and money transfer services; financial transaction services, namely, providing secure payment and remittance transactions; including all of the aforementioned services provided by electronic means; foreign currency transfer services; foreign currency exchange; currency trading; currency dealing; brokerage of currency ; financial transactions via blockchain; fundraising and financial sponsorship; brokerage of carbon offsets; financial sponsorship of carbon offset programmes; funding of and investment in emissions reduction projects; Investment in emissions reduction funds; provision of loans; providing temporary loans; electronic wallet services (payment services); payment services and transfer of funds by means of payment terminals; financial services, namely, the provision of contactless mobile payments through merchants at retail, online and wholesale locations; financial risk management services; financial transaction analysis, namely, analyzing transactions for payment fraud, illegality and compliance with payment transaction regulations and antifraud and money laundering controls; providing purchase protection services for goods and services purchased by others via a global computer network and wireless networks, namely, providing fraud reimbursement services in the field of credit card purchases and electronic payment purchases, and providing secure commercial transactions for credit card purchases and electronic payment purchases; reimbursement of funds for disputed items in the field of electronic payment purchases; financial services in relation to and for

**ANTCOIN**

---

facilitating the buying, selling, trading and management of digital currency, blockchain tokens, and other digital assets on a trading platform; financial services related to digital wallets and electronic wallets, including secure storage and transaction processing of digital assets; issuance of tokens of value; redeeming the tokens of value of others for payment of goods or services; financial consultancy services related to blockchain technology, digital assets, smart contracts and the integration of traditional and decentralised financial systems; digital currency, cryptocurrency, stable coin and virtual currency services; digital currency wallet and storage services; custodian electronic wallet services In relation to digital currency, cryptocurrency, stable coin, digital payment tokens and virtual currency; Issuance, transmission and transfer of stable coins and digital payment tokens; financial services relating to customer loyalty , incentive and reward programs; exchange and redemption services In relation to customer loyalty, incentive and reward programs; providing discount card services and other rebate services as part of a customer loyalty program; providing rebates at participating establishments of others through use of a membership card; consultancy, information and advisory services relating to the aforesaid services.) **(526)** : Registration of this mark shall give no right to the exclusive use of the word 'COIN' separately and apart from the mark as a whole. **(730)** : ADVANCED NEW TECHNOLOGIES CO., LTD of Cayman Corporate Centre, 27 Hospital Road, George Town, Grand Cayman KY1-9008, Cayman Islands **(740)** : CFL ADVOCATES of P. O. Box 23555 - 00100, Nairobi, Kenya

---

**(210)** : 140443 **(220)** : 24/06/2025 **(300)** : None **(511)** : 36(Services relating to insurance, financial affairs, monetary affairs and real estate affairs; investment services; advisory and consultancy services in relation to all the foregoing.) **(526)** : Registration of this mark shall give no right to the exclusive use of the words 'ASSET' and ('MANAGEMENT' each separately and apart from the mark as a whole. **(730)** : CORONATION ASSET MANAGEMENT (PTY) LTD. of Seventh Floor, Montclare Place, Corner Campground and Main Roads, Claremont, Cape Town 7708, South Africa **(740)** : Ndung'u Njoroge & Kwach of P. O. Box 41546 - 00100, Nairobi,

## CORONATION ASSET MANAGEMENT

---

**(210)** : 140594 **(220)** : 03/07/2025 **(300)** : None **(511)** : 41(Education (to develop and administer examinations for professional supply chain management certification); certification (To certify persons who have met educational, professional and ethical standards in procurement and supply chain management) **(526)** : Registration of this mark shall give no right to the exclusive use of the words 'CERTIFIED', 'PROCUREMENT', 'PUBLIC', 'PROFESSIONAL', the letters 'C' and 'P' each separately and apart from the mark as a whole. **(730)** : KENYA INSTITUTE OF SUPPLIES EXAMINATION BOARD (KISEB) A parastatal established under the supplies practitioners management (SPM) Act No. 17 of P. O. Box 22873 - 00505, 2007 of KISM Towers, 11th Floor, , Nairobi, Kenya **(740)** : Guandar Thuita & Company Advocates of P. O. Box 19539 - 00100, Nairobi, Kenya

## Certified Public Procurement Professional (CPPP)

---

**(210)** : 140659 **(220)** : 08/07/2025 **(300)** : None **(511)** : 36(Insurance; Financial Affairs; Monetary Affairs; Real Estate Affairs) **(526)** : Registration of this mark shall give no right to the exclusive use of the word "HOMES" separately and apart from the mark as a whole. 'ATANA' is a Kikuyu word that translates to 'Generous' in English. **(730)** : GEORGE NGIGE KAHIRA of P. O. Box 14175 - 00100, Nairobi, Kenya **(740)** : None,



atana Homes

**(210)** : 140672 **(220)** : 08/07/2025 **(300)** : None **(511)** : 3(Non-medicated lip care, skin care, foot care and personal care topical preparations; non-medicated topical lip care, skin care and foot care preparations for moisturization, dryness, soothing, cooling, burns, for cleansing the skin, lips and feet, to prevent or alleviate the symptoms of acne and other skin afflictions; nonmedicated lotions, powders, gels, balms, creams, salves and/or ointments for use on the lips, skin and feet; non-medicated topical sunscreen preparations for use on the lips and skin; foot and skin care preparations for absorbing or preventing wetness and to absorb, neutralize and prevent odors; deodorant powders and sprays that also absorb wetness that may be applied to footwear, socks, hosiery and clothing for use as a personal deodorant; and applicators, towelettes or pads sold as a component with the foregoing goods.), 5(Medicated lip care, skin care, foot care and personal care topical preparations; medicated topical preparations for lip care, skin care and foot care, for moisturization, dryness, soothing, cooling, burns, itching, for cleansing the skin, lips and feet, to prevent or alleviate the symptoms of acne and other skin afflictions; topical and oral analgesic preparations, topical cold sore medications; topical and oral antibiotic preparations; topical antiseptics; topical hemorrhoidal Preparations; topical medications for the treatment of skin irritations and inflammations; topical pain relief medications; topical medications for insect bites and for treating allergic reactions; medicated lotions, powders, gels, balms, creams, salves and/or ointments for use on the lips, skin and feet; witch hazel; medicated preparations for the relief of the discomfort of mouth and gum sores and irritations; medicated mouth and gum care preparations; medicated topical sunscreen preparations for use on the lips and skin; medicated foot and skin care sprays and powders; anti-infective foot and skin sprays and powders; antifungal foot and shoe sprays and powders; medicated preparations for the treatment of athlete's foot, for alleviating itching and for treating other foot and skin irritations; deodorant powders and sprays that also absorb wetness for use as a clothing deodorant on footwear, socks, hosiery, and clothing; and medicated applicators, towelettes or pads sold as a component with the foregoing goods.), 10(Insoles and inserts for footwear and shoes to absorb wetness being primarily for orthopedic purposes; insoles and inserts for footwear and shoes for absorbing, neutralizing and preventing odors being primarily for orthopedic purposes; insoles and inserts for footwear and shoes for deodorizing being primarily for orthopedic purposes; insoles and inserts for footwear and shoes for cushioning being primarily for orthopedic purposes; footwear cushions and pads designed and treated to absorb moisture and absorb, neutralize and prevent odors being primarily for orthopedic purposes.) and 25(Insoles and inserts for footwear and shoes to absorb wetness being primarily for non-orthopedic purposes; insoles and inserts for footwear and shoes for absorbing, neutralizing and preventing odors being primarily for non-orthopedic purposes; insoles and inserts for footwear and shoes for deodorizing being primarily for non-orthopedic purposes; insoles and inserts for footwear and shoes for cushioning being primarily for non-orthopedic purposes; footwear cushions and pads designed and treated to absorb moisture and absorb, neutralize and prevent odors being primarily for non-orthopedic purposes.) **(526)** : None **(730)** : BLISTEX INC of 1800 Swift Drive Oak Brook, Illinois 60523, United States of America **(740)** : Kaplan & Stratton Advocates of P. O. Box 40111 - 00100, Nairobi, Kenya

**BLISTEX**

(210) : 140715 (220) : 09/07/2025 (300) : None (511) : 35(Advertising, business management, business consultation) and 41(Education, providing of training, entertainment, sporting and cultural activities) (526) : KIVUKONI Registration of this mark shall give no right to the exclusive use of the words "KIVUKONI", "INTERNATIONAL", "SECONDARY", "STUDENT", "THRIVE", the letters "K", "V" and the numeral "2" each separately and apart from the mark as a whole. (730) : KIVUKONI LIMITED of P. O. Box 1500 - 80108, Kilifi, Kenya (740) : Onyango & Ameyo Advocates of P. O. Box 16345 - 00100, Nairobi, Kenya



(210) : 140716 (220) : 09/07/2025 (300) : None (511) : 35(Advertising, business management, business consultation) and 41(Education, providing of training, entertainment, sporting and cultural activities) (526) : KIVUKONI Registration of this mark shall give no right to the exclusive use of the words "KIVUKONI", "SCHOOL", "CHILDREN" and "LEARN" each separately and apart from the mark as a whole. (730) : KIVUKONI LIMITED of P. O. Box 1500 - 80108, Kilifi, Kenya (740) : Onyango & Ameyo Advocates of P. O. Box 16345 - 00100, Nairobi, Kenya



(210) : 140806 (220) : 14/07/2025 (300) : None (511) : 5(Pharmaceuticals Preparations.) (526) : Registration of this mark shall give no right to the exclusive use of the word "KIT", "PYLORIC" and the device of "CAPSULES" per se, each separately and apart from the mark as a whole. (730) : WAREHOUSE PHARMACEUTICALS LIMITED of P. O. Box 1120 - 00100, Nairobi, Kenya (740) : None,



(210) : 140807 (220) : 14/07/2025 (300) : None (511) : 5(Pharmaceuticals Preparations.) (526) : Registration of this mark shall give no right to the exclusive use of the devices of 'CAPSULES' per se, separately and apart from the mark as a whole. (730) : WAREHOUSE PHARMACEUTICALS LIMITED of P. O. Box 1120 - 00100, Nairobi, Kenya (740) : None,



(210) : 140838 (220) : 15/07/2025 (300) : None (511) : 41(Education; Providing of training; entertainment, betting, sporting and cultural activities.) (526) : Registration of this mark shall give no right to the exclusive use of the letter 'B' and "KE" each separately and apart from the mark as a whole. (730) : PLANET COMMUNICATION LIMITED of P. O. Box 258 - 00100, Nairobi, Kenya (740) : None,



(210) : 140854 (220) : 16/07/2025 (300) : None (511) : 35(Fast Moving Consumer Goods (FMCG), Retail and wholesale services, including general merchandise store services, online or physical store operations, marketing, and sales of a variety of goods.) (526) : Registration of this mark shall give no right to the exclusive use of the word 'PATA' and 'DEALS' each separately and apart from the mark as a whole. 'PATA' is a Swahili word meaning 'GET' in English. (730) : WILSON K KARAGO of P. O. Box 35341 - 00200, City Square, Nairobi, Kenya (740) : None,



(210) : 141002 (220) : 23/07/2025 (300) : None (511) : 4(Candle) (526) : BESTLIGHT Registration of this mark shall give no right to the exclusive use of the words "BESTLIGHT", "TROPICAL", "WHITE", "CANDLES", "NON DRIP", "QUALITY", the letters "G", "B", "L" and the device of "CANDLE" per se each separately and apart from the mark as a whole. (730) : GONAS BEST LTD of P. O. Box 78531- 00507, Nairobi, Kenya (740) : None,



(210) : 141097 (220) : 28/07/2025 (300) : None (511) : 5(Herbicide, fungicides, insecticides) (526) : None (730) : GREENLIFE CROP PROTECTION AFRICA LTD of P. O. Box 24942 - 00100, Nairobi, Kenya (740) : None,



(210) : 141098 (220) : 28/07/2025 (300) : None (511) : 5(Herbicide, fungicides, insecticides) (526) : None (730) : GREENLIFE CROP PROTECTION AFRICA LTD of P. O. Box 24942 - 00100, Nairobi, Kenya (740) : None,

**NIPROLE**

(210) : 141099 (220) : 28/07/2025 (300) : None (511) : 9(Audio and video recordings, downloadable music, scientific, research, navigation, surveying, photographic, cinematographic, audiovisual, optical, weighing, measuring, signaling, detecting, testing, inspecting, life-saving and teaching apparatus and instruments; apparatus and instruments for conducting, switching, transforming, accumulating, regulating or controlling the distribution or use of electricity; apparatus and instruments for recording, transmitting, reproducing or processing sound, images or data; recorded and downloadable media, computer software, blank digital or analogue recording and storage media; mechanisms for coin-operated apparatus; cash registers, calculating devices; computers and computer peripheral devices; diving suits, divers' masks, ear plugs for divers, nose clips for divers and swimmers, gloves for divers, breathing apparatus for underwater swimming; fire-extinguishing apparatus.), 16(Paper and cardboard;



printed matter; bookbinding material; photographs; stationery and office requisites, except furniture; adhesives for stationery or household purposes; drawing materials and materials for artists; paintbrushes; instructional and teaching materials; plastic sheets, films and bags for wrapping and packaging; printers' type, printing blocks.), 25(Clothing, footwear, headgear), 35(Advertising; business management, organization and administration; office functions.), 38(Telecommunications services.) and 41(Education; providing of training; entertainment; sporting and cultural activities) (526) : ONERegistration of this mark shall give no right to the exclusive use of the words "ONE", "NIGHT" and "ONLY" each separately and apart from the mark as a whole. (730) : PATRICK QUARCOO of P. O. Box 74497 - 00200, Nairobi, Kenya (740) : None,

(210) : 141128 (220) : 29/07/2025 (300) : None (511) : 3(Bleaching preparations and other substances for laundry use; cleaning, polishing, scouring and other abrasive preparations; soap; detergents.) (526) : Registration of this mark shall give no right to the exclusive use of the words 'AFRICA', 'WASHING', 'POWDER' and the device of 'MAP OF AFRICA' each separately and apart from the mark as a whole. (730) : BIDCO AFRICA LIMITED of P. O. Box 239 - 01000, General Kago Road, Thika, Kenya (740) : None,



(210) : 141185 (220) : 30/07/2025 (300) : None (511) : 5(Pharmaceuticals, medical and veterinary preparations; sanitary preparations for medical purposes; dietetic food and substances adapted for medical or veterinary use, food for babies; dietary supplements for human beings and animals; plasters, materials for dressings; material for stopping teeth, dental wax; disinfectants; preparations for destroying vermin; fungicides, herbicides.) (526) : None (730) : LABORATORY AND ALLIED LIMITED of P. O. Box 42875 - 00100, Nairobi, Kenya (740) : None,

**MYOTRAZ**

(210) : 141244 (220) : 05/08/2025 (300) : None (511) : 7(Machines and machine tools; motors and engines (except for land vehicles); machines coupling and transmission components (except for land vehicles); agricultural implements other than hand operated; incubators for eggs.) (526) : Registration of this mark shall give no right to the exclusive use of the word 'TECH' separately and apart from the mark as a whole. (730) : GEORGE NJOROGE NGURE of P. O. Box 6043 - 00100, Nairobi, Kenya (740) : None,

FixMyRig.tech

(210) : 141276 (220) : 06/08/2025 (300) : None (511) : 36(Financial, monetary and banking services; insurance services; real estate services) (526) : CASHRegistration of this mark shall give no right to the exclusive use of the words "CASH", "MALI", "INVESTMENTS" and the device of the "CURRENCY COINS" per se each separately and apart from the mark as a whole. The logo is to be used as is or filled with either "WHITE" or any of its primary colours. The name "MALICASH" is a creative wordplay using the Swahili and English language where "MALI" a Swahili word translates to "Wealth" or "Assets" in English. The mark is proceeding in series. (730) : CAROL SYOWIA NDISO of P. O. Box 1996 - 90100, Kenya Israel, Opposite Isuzu, Machakos, Kenya (740) : Wamaitha Gichamba & Co. Advocates of P. O. Box 11622 - 00400, Nairobi, Kenya



(210) : 141281 (220) : 06/08/2025 (300) : None (511) : 41(Education; providing of training; entertainment; sporting and cultural activities; gambling services) (526) : TVRegistration of this mark shall give no right to the exclusive use of the acronym "TV" separately and apart from the mark as a whole. 'BETIKA' has no attributable language and is a combination of the English word 'BET' and the word 'IKA' forming one word, with no meaning in English. (730) : BETIKA INTERNATIONAL LIMITED of Office 2, Suite 2, The Penthouse, Capital Business Centre, Entrance C, Triq taz-Zwejt, San Gwann SGN 3000, Malta (740) : Kieti Law LLP of P. O. Box 22602 - 00505, Nairobi, Kenya

## BETIKA TV

(210) : 141331 (220) : 11/08/2025 (300) : None (511) : 1(Agricultural product; used in agriculture, horticulture and forestry; unprocessed artificial resins, manures) (526) : None (730) : JUANCO GROUP LIMITED Manufacturers, developers and distributors of P. O. Box 381 - 00502, Karen, Nairobi, Kenya (740) : None,

## CALMAN

(210) : 141332 (220) : 11/08/2025 (300) : None (511) : 1(Agricultural product; used in agriculture, horticulture and forestry; unprocessed artificial resins, manures) (526) : None (730) : JUANCO GROUP LIMITED Manufacturers, developers and distributors of P. O. Box 381 - 00502, Karen, Nairobi, Kenya (740) : None,

## FOSMAZIN

(210) : 141430 (220) : 14/08/2025 (300) : None (511) : 18(Leather and imitation leather goods) and 25(Clothing, footwear, headgear) (526) : None (730) : SHARON WANJERI GICHERU of P. O. Box 33228 - 00600, Naivasha Road, Nairobi, Kenya (740) : None,

## ZIGObags

(210) : 141491 (220) : 18/08/2025 (300) : None (511) : 35(Advertising; business management, organization and administration; office functions) and 39(Transport; packaging and storage of goods; travel arrangement) (526) : TAXISRegistration of this mark shall give no right to the exclusive use of the word "TAXIS" and the acronym "LTD" each separately and apart from the mark as a whole. (730) : OFFICIAL RECEIVER IN INSOLVENCY of P. O. Box 30404 -00100, Nairobi, Kenya (740) : None,



(210) : 141694 (220) : 27/08/2025 (300) : None (511) : 5(Herbicide, fungicides, insecticides ) (526) : None (730) : GREENLIFE CROP PROTECTION AFRICA LTD of P. O. Box 24942 - 00100 , Nairobi, Kenya (740) : None,

## FORTIVAX

(210) : 141696 (220) : 27/08/2025 (300) : None (511) : 5(Herbicide, fungicides, insecticides) (526) : None (730) : GROWMATE KENYA LTD of P. O. Box 18440 - 00100, Nairobi, Kenya (740) : None,

## PolyDeal

(210) : 141783 (220) : 29/08/2025 (300) : None (511) : 33(Fermented alcohol) (526) : Registration of this mark shall give no right to the exclusive use of the words 'GRAIN' and 'LIQUID' each separately and apart from the mark as a whole. "ZHONGJIAN" is a coined word with no specific meaning in English. The Chinese characters translates to "Zhongjian Grain Liquid". (730) : ZHONGJIAN GRAIN LIQUID CO LTD of P. O. Box 38407 - 00100, Nairobi, Kenya (740) : None,



(210) : 141923 (220) : 08/09/2025 (300) : None (511) : 5(Veterinary products; dietetic foods for veterinary use; disinfectants; products for the destruction of harmful animals; fungicides; vitamins.) (526) : Registration of this mark shall give no right to the exclusive of the word 'LIMITED' separately and apart from the mark as a whole. (730) : VETILOG PHARMA of 35 Cybercity Level 3, Alexander House, Ebene 72201, Mauritius (740) : Kieti Law LLP of P. O. Box 22602 - 00505, Nairobi, Kenya



(210) : 141942 (220) : 09/09/2025 (300) : None (511) : 1(Fertilizer, Foliar feed, plant Supplement) (526) : Registration of this mark shall give no right to the exclusive use of the words "GROW" and "EDGE" each separately and apart from the mark as a whole. (730): GROWMATE KENYA LTD of P. O. Box 18440 - 00100, Nairobi, Kenya (740) : None,

**GrowEdge**

(210) : 141963 (220) : 10/09/2025 (300) : None (511) : 32(Energy drinks; non-alcoholic beverages; mineral and aerated waters; fruit beverages and fruit juices; syrups and other preparations for making non-alcoholic beverages) (526) : Registration of this mark shall give no right to the exclusive use of the word 'XTREME' each separately and apart from the mark as a whole The word "SIMBA" is a swahili word whose english translation is "LION". The word "EXREME" does not have an english translation. It is distinct and original word that has been derived from the English word "EXTREME" which means exceeding the original, usual or expected. (730) : BIDCO AFRICA LIMITED of P. O. Box 239 - 01000, General Kago Road, Thika, Kenya (740) : None,

**BIDCO SIMBA XTREME**

(210) : 142033 (220) : 12/09/2025 (300) : None (511) : 12(Automobiles and their parts and fittings.) (526) : None (730) : DAIHATSU MOTOR CO., LTD of 1-1, Daihatsu-cho, Ikeda, Osaka, Japan (740) : Gichachi & Company Advocates of P. O. Box 79659 - 00200, Nairobi, Kenya

**DAIHATSU**

(210) : 142075 (220) : 15/09/2025 (300) : None (511) : 3(Soap; laundry preparations; cleaning preparations; shoe polish; grinding preparations; essential oils; cosmetics; dentifrices\*; incense; cosmetics for animals; air fragrancing preparations.) (526) : Registration of this mark shall give no right to the exclusive use of the word 'WORLD' separately and apart from the mark as a whole. The mark has no meaning in this application. (730) : YIWU UNION IMPORT & EXPORT CO., LTD of Floor 6 No.39 Suxin Road, Suxi Town, Yiwu City, Zhejiang Province, China (740) : CFL Advocates of P. O. Box 23555 - 00100, Nairobi, Kenya

**worldkiss**

(210) : 142115 (220) : 16/09/2025 (300) : None (511) : 29(Agar-agar for culinary purposes; arrangements of processed fruit; almond milk-based beverages; black pudding / blood sausage; candied nuts; cheese; coconut milk-based beverages; corn dogs; cottage cheese; cottage cheese fritters; cream [dairy products]; croquettes; compotes; crystallized fruits / frosted fruits; curd; fat-based spreads for bread slices; fish-based foodstuffs; fish-based snack food; flavoured nuts; freeze-dried meat; freeze-dried vegetables; fruit chips; fruit jelly spreads; fruit, preserved; fruit, processed; gelatin; ham; hash browns; hot dog sausages; jams; jellies for food, other than confectionery); lactic acid drinks; low-fat potato crisps; meat; meat extracts for culinary purposes; meat substitutes; meat-based snack food; milk; milk beverages, milk predominating; milk products; milk substitutes; nut-based spreads; nuts, prepared; peanut butter; potato crisps; potato flakes; potato fritters; poultry, not live; pressed fruit paste; salted meats; sausages, seeds, prepared; soups; soya milk; soya patties; tempeh; tofu; tofu patties; tofu-based snack food; tomato paste; tomato purée; vegetable-based snack food; vegetable-based spreads; vegetables, dried; vegetables, preserved; whey; yogurt; cheese sticks; cheese-based snack foods; cheese dips; processed cheese; cheese-based snacks; snack mixes consisting of dehydrated fruit and processed



---

nuts; fruit-based snack food; fruit-based crisps; crisps; grilled chicken; fried chicken; cooked chicken; dairy-based spreads; sweet corn-based snack foods; chicken nuggets; chicken wings; grilled meat; bacon; french fries; puffed potato chips; banana chips; cassava flakes; coconut chips; sweet potato chips; cassava chips; mango chips; tapioca chips ; yam chips; meat burgers; hamburgers; soy burgers; tofu burgers; turkey meat burgers; hot dogs; beef fillets; sliced fish; meat fillets; chicken products; processed chicken; frozen prepared meals; dried fruit bars; dried fruit-based snack food; milk-based drinks containing fruit juice; milk-based drink flavoured with chocolate; snacks; dairy products and milk substitutes; panna cotta; semifreddo panna; coffee creams; cream cheese; dried chicken; peanut spreads; tea with milk; chicken fillets; steaks; prepared meals consisting primarily of chicken; meatballs; frozen meals consisting primarily of chicken.) and 30(Almond confectionery; almond paste; aromatic preparations for food; batter mixes; Biscuits; bread rolls; bread; buns; cake batter; cakes; candy decorations for cakes; caramels [sweets]; cereal bars; cereal preparations; cereal-based snack food; cheeseburgers [sandwiches]; chips [cereal products]; chocolate; chocolate beverages with milk; chocolate mousses; chocolate spreads containing nuts; chocolate-based beverages; chocolate-based spreads; chocolate-coated nuts; chocolate-covered potato chips; chutneys [condiments]; cocoa; cocoa beverages with milk; cocoa nibs; cocoa-based beverages; coconut macaroons; coffee; coffee beverages with milk; coffee capsules, filled; coffee flavourings; coffee substitutes; coffee-based beverages; condiments; confectionery; confectionery in the form of mousses; cookies; corn flakes; crackers; croissants; Danish pastries; dulce de leche; edible ices; filled biscuits; flavoured jelly crystals for making jelly confectionery; flavourings, other than essential oils, for beverages; fondants confectionery]; food flavourings, other than essential oils; freeze-dried dishes with the main ingredient being pasta; freeze-dried dishes with the main ingredient being rice; frozen yogurt [confectionery ices]; fruit confectionery; fruit coulis [sauces]; fruit jellies [confectionery]; gingerbread; herbal teas; high-protein cereal bars; hot dog sandwiches; ice cream; ice pops; iced tea; instant rice; lozenges [confectionery]; macaroni; macarons; malt biscuits; marzipan; meat gravies; milk puddings; mint for confectionery; natural sweeteners; noodle-based prepared meals; pancakes; pasta; pasta sauce; pastries; pizzas; pies; pralines; profiteroles; puddings; ramen; rice cakes; rice crackers; rice-based snack food; roasted coffee beans; sandwiches; sauces [condiments]; seasonings; sorbets [ices]; spaghetti; spices; sweets; tarts; tea beverages with milk; tea substitutes; tea-based beverages; tea; treacle; vanilla flavourings for culinary purposes; waffles; extruded corn snacks; extruded tapioca starch-based snacks; extruded cassava starch-based snacks; cheese flavoured biscuits; Rolled wafers; wafers; wafer flakes; chocolate-covered cookies; chocolate-covered wafer biscuits; chocolate cookies; chocolate-based drinks; cocoa-based drinks; prepared cocoa-based drinks; chocolate wafers; caramel bars; non-medicated candy; chocolate chip; chocolate cake; chocolate-based snacks; noodles; tortillas; sushi; spices; royal jelly; popcorn; puffed corn based snacks; chewing gum; corn-bases snack food; chocolate truffle; toast; donuts; churros; snack bars; cheesecake; confectionery bars; granola bars; chocolate coated biscuits; chocolate biscuits; chocolate confectionery; brownies; sponge cake; cream tart; candies.) (526) : None Nabati is a coined brand element adopted from the company's legal entity name, PT Kaldu Sari Nabati Indonesia and does not refer to any specific meaning in any language. (730) : PT. KALDU SARI NABATI INDONESIA A Limited liability

---

company duly organised and existing under the laws of the Republic of Indonesia of Jl. Raya Cicalengka - Majalaya KM 1.6, Kp. Andir, RT 01 RW 03, Desa Cikuya, Kecamatan Cicalengka, Kabupaten Bandung, Indonesia **(740)** : CFL Advocates of P. O. Box 23555 - 00100, Nairobi, Kenya

**(210)** : 142120 **(220)** : 16/09/2025 **(300)** : None **(511)** : 9(Mobile application software and computer software in the field of health care for mobile phones, smartphones, smart watches, smart glasses, tablet computers, notebook computers, smart televisions, virtual reality headsets, and humanoid robots with artificial intelligence; Mobile application software and computer software for setting personal health and fitness goals, tracking progress, recording and analyzing biometric data, and tracking physical activity; Mobile application software and computer software for monitoring heart rate, blood pressure, blood glucose levels, blood oxygen saturation, respiratory function, hydration, and sleep analysis; Mobile application software and computer software for menstrual cycle and fertility tracking, stress monitoring, and relaxation training; Mobile application software and computer software for diet logging, calorie counting, and providing reminders to take medication; Mobile application software and computer software for managing personal health records, integrating medical devices and wearable health devices, and synchronizing firmware with mobile applications; Mobile application software and computer software for healthcare, medicine, patient care, medical records, and the downloading, storage, transmission, evaluation, and review of such records; Mobile application software and computer software for providing personalized health recommendations, generating health risk assessments, and offering fitness coaching and health advice; Mobile application software and computer software for connecting users with healthcare professionals, supporting social health challenges and step competitions, and providing gamification and reward systems in health applications) **(526)** : Registration of this mark shall give no right to the exclusive use of the word 'HEALTH' separately and apart from the mark as a whole. **(730)** : VIVO MOBILE COMMUNICATION CO., LTD a limited company organised and existing under the laws of China of No. 1, Vivo Road, Chang'an, Dongguan, Guangdong, China **(740)** : Coulson Harney LLP of P. O. Box 10643 - 00100, Nairobi, Kenya

## ORIGIN HEALTH

**(210)** : 142156 **(220)** : 18/09/2025 **(300)** : None **(511)** : 6(Metal materials for construction), 9(Electrical and scientific apparatus, such as energy control or management systems used in the development of power projects; Electrical energy utilization metering devices; electric control devices for energy management; energy meters for tracking and monitoring energy usage.), 35(Procurement services in the nature of purchasing energy supply for others; procurement of contracts concerning energy supply.), 37(Construction, repair and maintenance of power plants; repair and maintenance of wind power plants; repair or maintenance of nuclear power plants; installation, maintenance and repair of power plants and power grids; installation, repair and maintenance of power plant equipment; providing information relating to the repair or maintenance of nuclear power plants; repair and maintenance of wave energy power plants; installation, maintenance and repair of energy conversion apparatus, power plants, wave energy conversion apparatus and wave energy power plants; installation, maintenance and repair of energy conversion apparatus and power plants; installation, maintenance and repair of wave energy conversion apparatus and wave energy power plants; repair or maintenance of nuclear power plants and providing information relating thereto; erection, installation, maintenance and repair of windmills, wind



power plants, wind turbines and other wind-operated machines; Construction engineering services[construction consultancy]; construction project management construction supervision ; building construction consultancy.), 39(Energy distribution and supply; distribution and supply of energy; storage, distribution and supply of energy and fuel), 41(Providing training programs; mentoring [training]; business mentoring services; mentoring [education and training].) and 42(Technical consultancy in the field of environmental engineering; construction engineering services [technical project studies in the field of construction]; technical consulting in the field of environmental engineering; Design and development of energy distribution networks; development of energy and power management systems; research and development in the field of energy; design and development of systems for regenerative energy generation; research and development in the field of hydroelectric energy; research and development in the field of geothermal energy; construction engineering services [construction design]; technological consultancy in the field of alternative energy generation; technological consulting services in the field of alternative energy generation.) (526) : Registration of this mark shall give no right to the exclusive use of the words 'ENERGY', 'GROUP', the letters 'C', 'S' and 'I' each separately and apart from the mark as a whole. The mark is restricted to the colours "PANTONE 715C","PANTONE 719 C", "PANTONE 1365 C", "PANTONE 1225 C" and "PANTONE BLACK C" (730) : ENDELEVU of Wall Street Level 7/8 Tower C, 1 Exchange Square, Ebene, Mauritius (740) : Kieti Law LLP of P. O. Box 22602 - 00505, Nairobi, Kenya

(210) : 142216 (220) : 23/09/2025 (300) : None (511) : 29(Meat, fish, poultry and games; meat extracts; preserved, frozen, dried and cooked fruits and vegetables; jellies, jams, compotes; eggs; milk and milk products; edible oils and fats.) (526) : None 'DAIMA' is a Swahili word meaning 'Forever' in English. (730) : DEVYANI FOOD INDUSTRIES KENYA LIMITED of P. O. Box 102 - 00507, Nairobi, Kenya (740) : Eliud Maina Karanja AdvocateS of P. O. Box 6455 - 00200, Nairobi, Kenya

**DAIMA ALIVE**

(210) : 142217 (220) : 23/09/2025 (300) : None (511) : 29(Meat, fish, poultry and games; meat extracts; preserved, frozen, dried and cooked fruits and vegetables; jellies, jams, compotes; eggs; milk and milk products; edible oils and fats.) (526) : None 'DAIMA' is a Swahili word meaning 'Forever' in English. (730) : DEVYANI FOOD INDUSTRIES KENYA LIMITED of P. O. Box 102 - 00507, Nairobi, Kenya (740) : Eliud Maina Karanja AdvocateS of P. O. Box 6455 - 00200, Nairobi, Kenya

**DAIMA ACTIVE**

(210) : 142221 (220) : 23/09/2025 (300) : None (511) : 39(Transport and Storage) (526) : Registration of this mark shall give no right to the exclusive use of the letters "Q" , "T", the words "QUICK", "TASK", "FREIGHT", "LIMITED", "GLOBAL", "CARGO" and "PARTNER" each separately and apart from the mark as a whole (730) : QUICK TASK FREIGHT LIMITED of P. O. Box 11496 - 00400, Broadways Go Down, Athi River, Mombasa Road, Nairobi, Kenya (740) : None,



(210) : 142238 (220) : 24/09/2025 (300) : None (511) : 36(Real estate services) (526) : GROUP Registration of this mark shall give no right to the exclusive use of the words "GROUP", "AGENCY", "LTD", the letters "A", "G" and "M" each separately and apart from the mark as a whole. "MABSA" is from the Bantu language in Shona meaning "Works" or "Deeds". A praise name associated with achieving great things. (730) : MABSA GROUP AGENCY LTD of P. O. Box 1862 - 00610, Eastleigh, Nairobi, Kenya (740) : None,



(210) : 142251 (220) : 24/09/2025 (300) : None (511) : 12(Vehicles; apparatus for locomotion by land, air or water) (526) : RRegistration of this mark shall give no right to the exclusive use of the letters "R" and "Z" each separately and apart from the mark as a whole. (730) : RZ INNOVATIONS KENYA LIMITED of P. O. Box 13428 - 00400, Nairobi, Kenya (740) : Chege & Sang Co Advocates of P. O. Box 13428 - 00400, Nairobi, Kenya



(210) : 142286 (220) : 26/09/2025 (300) : None (511) : 9(Training software; simulation software (training); educational, coaching and learning software; mobile applications (apps); downloadable educational publications and course materials; downloadable and recorded educational, coaching and learning content, e-books), 35(Business information, advice and consultancy; Business management, business strategy implementation, business organization, business administration, leadership, business skills and sales promotion consultancy; Arranging and conducting of exhibitions and trade fairs for commercial purposes; Business management consultancy in the field of executive and leadership development; Career advisory services (other than education and training advice), 41(Educational and training services; Consultancy relating to business education; Publication of educational materials; Arranging and conducting of conferences; Coaching services; Career counselling; Organization of webinars) and 42(Design and development of training software; design and development of simulation software (training); design and development of educational, coaching and learning software; Design and development of mobile applications (apps); providing access to downloadable educational publications and course materials; providing access to downloadable and recorded educational, coaching and learning content, e-books; providing temporary use of an online platform for the purpose of hosting and providing access to a content in a digital format) (526) : Registration of this mark shall give no right to the exclusive use of the letters 'B', 'S' and 'T' each separately and apart from the mark as a whole. (730) : BTS GROUP AB of Grevgatan 34, 114 53 Stockholm, Sweden (740) : Perpetua N Law Advocates T/A Von Seidels Kenya of P. O. Box 785 - 00618, Ruaraka, Nairobi, Kenya



(210) : 142364 (220) : 30/09/2025 (300) : None (511) : 27(Floor coverings & wall decoration (printed, decorative wallpaper) (526) : CLADSRegistration of this mark shall give no right to the exclusive use of the words "CLADS", "COVERINGS" and "SUSTAINABLE SURFACES" each separately and apart from the mark as a whole. (730) : YNC GLOBAL CONNECT (K) LTD of P. O. Box 857 - 00606, Gallant, Parklands Road, Westlands, Sarit, Nairobi, Kenya (740) : None,



(210) : 142365 (220) : 30/09/2025 (300) : None (511) : 27(Floor coverings & wall decorations (printed decorative wallpaper)) (526) : CONNECTSRegistration of this mark shall give no right to the exclusive use of the words "CONNECTS", "GLOBALLY", the letters "Y", "N" and "C" each separately and apart from the mark as a whole. (730) : YNC GLOBAL CONNECT (K) LTD of P. O. Box 857 - 00606, Gallant, Parklands Road, Westlands, Sarit, Nairobi, Kenya (740) : None,



(210) : 142366 (220) : 30/09/2025 (300) : None (511) : 20(Furniture of wood base & metal.) (526) : PREMIUMRegistration of this mark shall give no right to the exclusive use of the word "PREMIUM" and the device of a "CROWN" each separately and apart from the mark as a whole. (730) : YNC GLOBAL CONNECT (K) LTD of P. O. Box 857 - 00606, Gallant, Parklands Road, Westlands, Sarit, Nairobi, Kenya (740) : None,



(210) : 142367 (220) : 30/09/2025 (300) : None (511) : 27(Floor coverings & wall decorations (printed decorative wallpaper) (526) : WALLSRegistration of this mark shall give no right to the exclusive use of the words "WALLS", "FLOORS" and "DECOR UNLIMITED" each separately and apart from the mark as a whole. (730) : YNC GLOBAL CONNECT (K) LTD of P. O. Box 857 - 00606, Gallant, Parklands Road, Westlands, Sarit, Nairobi, Kenya (740) : None,



(210) : 142454 (220) : 03/10/2025 (300) : None (511) : 25(Clothing, Footwear, Headgear) (526) : None 'CASO' is from a Kamba clan meaning 'A Builder Of Castles for Kings' in English. (730) : JAMES MUTUNGA MUTISYA of P. O. Box 56603 - 00200, Embakasi, Kenya (740) : None,

### CASO

(210) : 142508 (220) : 07/10/2025 (300) : None (511) : 36(Real estate) (526) : Registration of this mark shall give no right to the exclusive use of the letters 'L' and 'V' each separately and apart from the mark as a whole. The application is restricted to the colors 'GOLD' and 'BLUE' as per the attached marks. 'MARINA' means a 'Dock or Basin' providing secure moorings for pleasure boats and often offering supply, repair and other facilities' in English. The mark is proceeding in series. (730) : GULFCAP REAL ESTATE LIMITED of P. O. Box 76632 - 00508, Merchande Square, Block A, 5th Floor, Kenya (740) : Ronn Law Advocates LLP of P. O. Box 12985 -00100, Nairobi, Kenya



(210) : 142545 (220) : 09/10/2025 (300) : None (511) : 41(Digital education services) (526) : Registration of this mark shall give no right to the exclusive use of the word "MSINGI", the letter "E" and the device of the "GRADUATION CAP" per se each separately and apart from the mark as a whole. The word "MSINGI" is of Swahili origin and translates into English as "Foundation" or "Basis". (730) : STRATHMORE UNIVERSITY of P. O. Box 59875 - 00200, Madaraka Estates, Ole Sangale Road, Nairobi, Kenya (740) : None,



(210) : 142548 (220) : 09/10/2025 (300) : None (511) : 9(Downloadable computer software and mobile applications) (526) : None (730) : MARTIN NYAGISERA OMBIRO of P. O. Box 536 - 20115, Njoro, Nakuru, Kenya (740) : None,

### GARISCAN

(210) : 142557 (220) : 13/10/2025 (300) : None (511) : 1(Adhesives used in industry) and 9(Electrical sockets, switches, bulb holders regulating or controlling electricity, electrical cables) (526) : None (730) : APPLE FARM CO. LTD of P. O. Box 9046 - 00300, Nairobi, Kenya (740) : None,

### BOMA

(210) : 142563 (220) : 13/10/2025 (300) : None (511) : 32(Beers; non-alcoholic beverages; mineral and aerated waters; fruit beverages and fruit juices; syrups and other preparations for making non-alcoholic beverages) (526) : Registration of this mark shall give no right to the exclusive use of the word 'STRAWBERRY' separately and apart from the mark as a whole. (730) : THE COCA-COLA COMPANY A Delaware corporation of One Coca-Cola Plaza, Atlanta GA 30313, United States of America (740) : Coulson Harney LLP of P. O. Box 10643 - 00100, Nairobi, Kenya

### STRAWBERRY BLAST

(210) : 142565 (220) : 13/10/2025 (300) : None (511) : 32(Beers; non-alcoholic beverages; mineral and aerated waters; fruit beverages and fruit juices; syrups and other preparations for making non-alcoholic beverages) (526) : Registration of this mark shall give no right to the exclusive use of the word 'PINEAPPLE' separately and apart from the mark as a whole. (730) : THE COCA-COLA COMPANY A Delaware corporation of One Coca-Cola Plaza, Atlanta GA 30313, United States of America (740) : Coulson Harney LLP of P. O. Box 10643 - 00100, Nairobi, Kenya

### ELECTRIC PINEAPPLE

<p>(210) : 142579 (220) : 14/10/2025 (300) : None (511) : 43(Hotel accommodation services; accommodation bureau services (hotels, boarding houses); food and drink catering; café services; cafeteria services; canteen services; restaurant services; hotel reservations; bar services; reception services for temporary accommodation (management of arrivals and departures); personal chef services; rental of meeting rooms.) (526) : None "ANDA" is an invented word and does not have any specific meaning. (730) : ANDA LUCKVGET HOTEL MANAGEMENT LIMITED of Unit 03B-05, 36/F, Electric Road, North Point, Hong Kong (740) : Iseme, Kamau &amp; Maema Advocates of P. O. Box 11866 - 00400, Nairobi, Kenya</p>	
<p>(210) : 142584 (220) : 14/10/2025 (300) : None (511) : 24(Bedsheets of leather; woolen blankets; sleeping bags; mosquito nets; bed linen; bed covers; household linen; quilt covers; silk fabrics; labels of textile.) (526) : None (730) : SHENZHEN FUANNA BEDDING AND FURNISHING COMPANY LIMITED Incorporated in The People's Republic of China of No. 1 Building Bicycle Processing Factory, Chuangyenan Nanyou Xilu, Nnshan District, Shenzhen, Guangdong, China (740) : CFL Advocates of P. O. Box 23555 - 00100, Nairobi, Kenya</p>	
<p>(210) : 142600 (220) : 15/10/2025 (300) : None (511) : 5(Herbicide, fungicides, insecticides) (526) : None (730) : SERAVA LIFESCENCES GROUP LTD of P. O. Box 46733 - 00100, Nairobi, Kenya (740) : None,</p>	<p><b>AVERMIONX</b></p>
<p>(210) : 142601 (220) : 15/10/2025 (300) : None (511) : 5(Herbicide, fungicides, insecticides) (526) : None (730) : SERAVA LIFESCENCES GROUP LTD of P. O. Box 46733 - 00100, Nairobi, Kenya (740) : None,</p>	<p><b>ZOVIRALIS</b></p>
<p>(210) : 142603 (220) : 15/10/2025 (300) : None (511) : 5(Herbicide, fungicides, insecticides) (526) : None (730) : SERAVA LIFESCENCES GROUP LTD of P. O. Box 46733 - 00100, Nairobi, Kenya (740) : None,</p>	<p><b>TRIBASE</b></p>
<p>(210) : 142604 (220) : 15/10/2025 (300) : None (511) : 5(Herbicide, fungicides, insecticides) (526) : None (730) : SERAVA LIFESCENCES GROUP LTD of P. O. Box 46733 - 00100, Nairobi, Kenya (740) : None,</p>	<p><b>QUANTAVA</b></p>
<p>(210) : 142606 (220) : 15/10/2025 (300) : None (511) : 5(Herbicide, fungicides, insecticides) (526) : None (730) : SERAVA LIFESCENCES GROUP LTD of P. O. Box 46733 - 00100, Nairobi, Kenya (740) : None,</p>	<p><b>PICORUSTA</b></p>
<p>(210) : 142607 (220) : 15/10/2025 (300) : None (511) : 5(Herbicide, fungicides, insecticides) (526) : None (730) : SERAVA LIFESCENCES GROUP LTD of P. O. Box 46733 - 00100, Nairobi, Kenya (740) : None,</p>	<p><b>NYMPHIA</b></p>
<p>(210) : 142610 (220) : 15/10/2025 (300) : None (511) : 5(Herbicide, fungicides, insecticides) (526) : None (730) : SERAVA LIFESCENCES GROUP LTD of P. O. Box 46733 - 00100, Nairobi, Kenya (740) : None,</p>	<p><b>LARVONIL</b></p>
<p>(210) : 142611 (220) : 15/10/2025 (300) : None (511) : 5(Herbicide, fungicides, insecticides) (526) : None (730) : SERAVA LIFESCENCES GROUP LTD of P. O. Box 46733 - 00100, Nairobi, Kenya (740) : None,</p>	<p><b>DUALESA</b></p>
<p>(210) : 142612 (220) : 15/10/2025 (300) : None (511) : 5(Herbicide, fungicides, insecticides) (526) : None (730) : SERAVA LIFESCENCES GROUP LTD of P. O. Box 46733 - 00100, Nairobi, Kenya (740) : None,</p>	<p><b>DIZORIUM</b></p>
<p>(210) : 142613 (220) : 15/10/2025 (300) : None (511) : 5(Herbicide, fungicides, insecticides) (526) : None (730) : SERAVA LIFESCENCES GROUP LTD of P. O. Box 46733 - 00100, Nairobi, Kenya (740) : None,</p>	<p><b>CYPHORA</b></p>
<p>(210) : 142614 (220) : 15/10/2025 (300) : None (511) : 5(Herbicide, fungicides, insecticides) (526) : None (730) : SERAVA LIFESCENCES GROUP LTD of P. O. Box 46733 - 00100, Nairobi, Kenya (740) : None,</p>	<p><b>CUPROMAX</b></p>
<p>(210) : 142615 (220) : 15/10/2025 (300) : None (511) : 5(Herbicide, fungicides, insecticides) (526) : None (730) : SERAVA LIFESCENCES GROUP LTD of P. O. Box 46733 - 00100, Nairobi, Kenya (740) : None,</p>	<p><b>CUPRAVA</b></p>

(210) : 142616 (220) : 15/10/2025 (300) : None (511) : 5(Herbicide, fungicides, insecticides) (526) : None (730) : SERAVA LIFESCIENCES GROUP LTD of P. O. Box 46733 - 00100, Nairobi, Kenya (740) : None,	<b>CLOFENZA</b>
(210) : 142617 (220) : 15/10/2025 (300) : None (511) : 5(Herbicide, fungicides, insecticides) (526) : None (730) : SERAVA LIFESCIENCES GROUP LTD of P. O. Box 46733 - 00100, Nairobi, Kenya (740) : None,	<b>CARVEXIA</b>
(210) : 142618 (220) : 15/10/2025 (300) : None (511) : 5(Herbicide, fungicides, insecticides) (526) : None (730) : SERAVA LIFESCIENCES GROUP LTD of P. O. Box 46733 - 00100, Nairobi, Kenya (740) : None,	<b>BUGTANA</b>
(210) : 142619 (220) : 15/10/2025 (300) : None (511) : 5(Herbicide, fungicides, insecticides) (526) : None (730) : SERAVA LIFESCIENCES GROUP LTD of P. O. Box 46733 - 00100, Nairobi, Kenya (740) : None,	<b>AFRINOVA</b>
(210) : 142639 (220) : 16/10/2025 (300) : None (511) : 5(Herbicide, fungicides, insecticides) (526) : Registration of this mark shall give no right to the exclusive use of the words "GUARD" and "GRANULES" each separately and apart from the mark as a whole. (730) : SERAVA LIFESCIENCES GROUP LTD of P. O. Box 46733 - 00100, Nairobi, Kenya (740) : None,	<b>SERPIGUARD GRANULES</b>
(210) : 142640 (220) : 16/10/2025 (300) : None (511) : 5(Herbicide, fungicides, insecticides) (526) : None (730) : SERAVA LIFESCIENCES GROUP LTD of P. O. Box 46733 - 00100, Nairobi, Kenya (740) : None,	<b>ETERNIX</b>
(210) : 142651 (220) : 16/10/2025 (300) : None (511) : 5(Herbicide, fungicides, insecticides) (526) : None (730) : SERAVA LIFESCIENCES GROUP LTD of P. O. Box 46733 - 00100, Nairobi, Kenya (740) : None,	<b>MOSQUIGARD</b>
(210) : 142652 (220) : 16/10/2025 (300) : None (511) : 1(Fertilizer, Foliar feed, Plant supplement) (526) : Registration of this mark shall give no right to the exclusive use of the words "MICRO" and "VITAL" each separately and apart from the mark as a whole. (730) : SERAVA LIFESCIENCES GROUP LTD of P. O. Box 46733 - 00100, Nairobi, Kenya (740) : None,	<b>MICROVITAL</b>
(210) : 142653 (220) : 16/10/2025 (300) : None (511) : 1(Fertilizer, Foliar feed, Plant supplement) (526) : EDGERegistration of this mark shall give no right to the exclusive use of the words "MICRO" and "EDGE" each separately and apart from the mark as a whole. (730) : SERAVA LIFESCIENCES GROUP LTD of P. O. Box 46733 - 00100, Nairobi, Kenya (740) : None,	<b>MICROEDGE</b>
(210) : 142654 (220) : 16/10/2025 (300) : None (511) : 5(Herbicide, fungicides, insecticides) (526) : MAXRegistration of this mark shall give no right to the exclusive use of the word "MAX" separately and apart from the mark as a whole. (730) : SERAVA LIFESCIENCES GROUP LTD of P. O. Box 46733 - 00100, Nairobi, Kenya (740) : None,	<b>MAXORA</b>
(210) : 142655 (220) : 16/10/2025 (300) : None (511) : 1(Fertilizer, foliar feed, plant supplement) (526) : LIONRegistration of this mark shall give no right to the exclusive use of the words "LION", "PLUS", the letters "N", "P" and "K" each separately and apart from the mark as a whole. (730) : SERAVA LIFESCIENCES GROUP LTD of P. O. Box 46733 - 00100, Nairobi, Kenya (740) : None,	<b>LIONPLUS NPK</b>
(210) : 142656 (220) : 16/10/2025 (300) : None (511) : 5(Herbicide, fungicides, insecticides) (526) : Registration of this mark shall give no right to the exclusive use of the word "STAR" separately and apart from the mark as a whole. (730) : SERAVA LIFESCIENCES GROUP LTD of P. O. Box 46733 - 00100, Nairobi, Kenya (740) : None,	<b>CIRISTAR</b>
(210) : 142657 (220) : 16/10/2025 (300) : None (511) : 1(Fertilizer, foliar feed, plant supplement) (526) : None (730) : SERAVA LIFESCIENCES GROUP LTD of P. O. Box 46733 - 00100, Nairobi, Kenya (740) : None,	<b>BOROCAL</b>

(210) : 142658 (220) : 16/10/2025 (300) : None (511) : 1(Fertilizer, foliar feed, plant supplement) (526) : MAXRegistration of this mark shall give no right to the exclusive use of the word "MAX" separately and apart from the mark as a whole. (730) : SERAVA LIFESCENCES GROUP LTD of P. O. Box 46733 - 00100, Nairobi, Kenya (740) : None,

**BIOTHRIVE MAX**

(210) : 142669 (220) : 16/10/2025 (300) : None (511) : 11( Bath fittings; bath installations, bath plumbing fixtures; bath tubs; bath tubs for sitz baths; bidets; flushing tanks; sanitary apparatus and installations; shower cubicles, shower enclosures; showers; sinks; taps\* , faucets\*; mixer taps for water pipes, mixer faucets for water pipes; taps for pipes and pipelines, cocks for pipes and pipelines, faucets for pipes and pipelines, spigots for pipes and pipelines; toilet bowls; toilet seats; toilets water-closets, water closets; toilets, portable; urinals being sanitary fixtures; wash-hand basins parts of sanitary installations, wash-hand bowls parts of sanitary installations; water flushing installations, flushing apparatus; pipes parts of sanitary installations, waterpipes for sanitary installations; water heaters; water supply installations; water conduits installations) and 20(Mirrors looking glasses; silvered glass mirrors; mirror tiles) (526) : Registration of this mark shall give no right to the exclusive use of the word "UTOPIA" separately and apart from the mark as a whole. (730) : UTOPIA BATH & KITCHEN GENERAL TRADING L.L.C of Showroom 9-11, Albahar Building, Salahuddin Street, Deira, Dubai, United Arab Emirates (740) : Ong'anya Ombo Advocates LLP of P. O. Box 15598 - 00400, Nairobi, Kenya

**Utopia**

(210) : 142688 (220) : 21/10/2025 (300) : None (511) : 34(Vapes; electronic cigarettes; personal and oral vaporisers for smokers; cases and holders for the aforesaid goods; liquid solutions and flavourings for use in vapes, electronic cigarettes and personal and oral vaporisers for smokers; e-liquids; flavourings for use in vapes, electronic cigarettes, personal and oral vaporisers for smokers; cartridges and other refill devices for use in vapes, electronic cigarettes and personal and oral vaporisers for smokers; replacement pods for use in vapes, electronic cigarettes and personal and oral vaporisers for smokers; parts and fittings for the aforesaid goods; smokers articles) (526) : None (730) : HYPERVAPE VENTURES LIMITED UK Limited Company of Entura House, 2 Arlington Square, Downshireway Bracknell, Berkshire, RG12 1WA, United Kingdom (740) : Perpetua N Law Advocates T/A Von Seidels Kenya of P. O. Box 785 - 00618, Ruaraka, Nairobi, Kenya

**HYOLA**

(210) : 142696 (220) : 21/10/2025 (300) : None (511) : 41(Education; providing of training; entertainment; sporting and cultural activities.) (526) : FITNESSRegistration of this mark shall give no right to the exclusive use of the word "FITNESS" and the device of "KETTLEBELL" each separately and apart from the mark as a whole (730) : PINPOINT INVESTMENT IN COMMERCIAL ENTERPRISES & MANAGEMENT L.L.C of Rasis Business Center Building 5th Floor Office # ZNAB 22, Al Barsha 1 Street Al Barsha 1, United Arab Emirates (740) : CFL Advocates of P. O. Box 23555 - 00100, Nairobi, Kenya



(210) : 142721 (220) : 22/10/2025 (300) : None (511) : 16(Paper and cardboard; printed matter; bookbinding material; photographs; stationery and office requisites, except furniture; adhesives for stationery or household purposes; drawing materials and materials for artists; paintbrushes; instructional and teaching materials; plastic sheets, films and bags for wrapping and packaging in printers' type printing blocks) and 35(Advertising; business management, organization and administration; office functions; arranging and

**IVORY BLOOM**

conducting of commercial events; organisation of cosplay entertainment events; arranging and conducting of entertainment events; provision of and organisation and arrangement of tents, decor and materials for co rate events, private functions, and social gatherings.) (526) : None (730) : MARYANNE MURIITHI of P. O. Box 51193 - 00200, Nairobi, Kenya (740) : Iseme Kamau & Maema Advocates of P. O. Box 11866 - 00400, Nairobi, Kenya

(210) : 142725 (220) : 22/10/2025 (300) : None (511) : 5(Herbicide, fungicides, insecticides) (526) : None (730) : SERAVA LIFESCIENCES GROUP LTD of P. O. Box 46733 - 00100, Nairobi, Kenya (740) : None,

**SUPPRESSIA**

(210) : 142726 (220) : 22/10/2025 (300) : None (511) : 5(Herbicide, fungicides, insecticides) (526) : None (730) : SERAVA LIFESCIENCES GROUP LTD of P. O. Box 46733 - 00100, Nairobi, Kenya (740) : None,

**VECTORIX**

(210) : 142727 (220) : 22/10/2025 (300) : None (511) : 5(Herbicide, fungicides, insecticides) (526) : None (730) : SERAVA LIFESCIENCES GROUP LTD of P. O. Box 46733 - 00100, Nairobi, Kenya (740) : None,

**RESCORAX**

(210) : 142728 (220) : 22/10/2025 (300) : None (511) : 5(Herbicide, fungicides, insecticides) (526) : None (730) : SERAVA LIFESCIENCES GROUP LTD of P. O. Box 46733 - 00100, Nairobi, Kenya (740) : None,

**MITONA**

(210) : 142729 (220) : 22/10/2025 (300) : None (511) : 5(Herbicide, fungicides, insecticides) (526) : None (730) : SERAVA LIFESCIENCES GROUP LTD of P. O. Box 46733 - 00100, Nairobi, Kenya (740) : None,

**KOPRINIL**

(210) : 142730 (220) : 22/10/2025 (300) : None (511) : 5(Herbicide, fungicides, insecticides) (526) : None (730) : SERAVA LIFESCIENCES GROUP LTD of P. O. Box 46733 - 00100, Nairobi, Kenya (740) : None,

**HERBIFEN**

(210) : 142731 (220) : 22/10/2025 (300) : None (511) : 5(Herbicide, fungicides, insecticides) (526) : None (730) : SERAVA LIFESCIENCES GROUP LTD of P. O. Box 46733 - 00100, Nairobi, Kenya (740) : None,

**GRAINPROX**

(210) : 142732 (220) : 22/10/2025 (300) : None (511) : 5(Herbicide, fungicides, insecticides) (526) : None (730) : SERAVA LIFESCIENCES GROUP LTD of P. O. Box 46733 - 00100, Nairobi, Kenya (740) : None,

**DOMOPHYT**

(210) : 142733 (220) : 22/10/2025 (300) : None (511) : 5(Herbicide, fungicides, insecticides) (526) : None (730) : SERAVA LIFESCIENCES GROUP LTD of P. O. Box 46733 - 00100, Nairobi, Kenya (740) : None,

**DIFLOCURA**

(210) : 142735 (220) : 22/10/2025 (300) : None (511) : 5(Herbicide, fungicides, insecticides) (526) : BROADRegistration of this mark shall give no right to the exclusive use of the words "BROAD" and "WALL" each separately and apart from the mark as a whole (730) : SERAVA LIFESCIENCES GROUP LTD of P. O. Box 46733 - 00100, Nairobi, Kenya (740) : None,

**BROADWALL**

(210) : 142736 (220) : 22/10/2025 (300) : None (511) : 5(Herbicide, fungicides, insecticides) (526) : None (730) : SERAVA LIFESCIENCES GROUP LTD of P. O. Box 46733 - 00100, Nairobi, Kenya (740) : None,

**BOTRILOCK**

(210) : 142748 (220) : 23/10/2025 (300) : None (511) : 41(Education; providing of training; entertainment; sporting and cultural activities) and 43(Services for providing food and drink; temporary accommodation) (526) : ,Registration of this mark shall give no right to the exclusive use of the words "GRAND", "HOTEL", "STYLE" and "LUXURY" each separately and apart from the mark as a whole. (730) : DALTON GRAND HOTEL of P. O. Box 19 -10202, Kangema, Kenya (740) : None,



**(210)** : 142752 **(220)** : 23/10/2025 **(300)** : None **(511)** : 36(Financial monetary and banking services) **(526)** : Registration of this mark shall give no right to the exclusive use of the words 'ACCOUNT' and 'LEGACY' each separately and apart from the mark as a whole. The english translation of the kiswahili "BOBEA" is "To Excel". **(730)** : UNAITAS SACCO SOCIETY LIMITED of P. O. Box 38721 - 00100, Nairobi, Kenya **(740)** : Mutua Waweru & Company Advocates of P. O. Box 102998 - 00101, Nairobi, Kenya

## Bobe Legacy Account

**(210)** : 142824 **(220)** : 27/10/2025 **(300)** : None **(511)** : 28(Toys, Games, board games) **(526)** : PLAYRegistration of this mark shall give no right to the exclusive use of the word "PLAY" separately and apart from the mark as a whole "KHOJA" is a name derived from a village, coined to make "KHOJAPOLY". 'Juro' is a Gujarati word meaning a small offering usually used in Holy/ Religious conotations. 'Khojillionaire' is an amalgamation of two words – 'Khoja' and 'Millionaire' Khoja comes from the Gujarati word 'Khwaja' which is a colloquial way of referring to Ismaili Muslim community in East Africa. Millionaire is a person whose wealth is measured in millions. **(730)** : TAHNIA PEERBHOY; KABIR SAILESH PATEL; FATEMA KURBAN JIVAJEE; FAHIM FIAZ SHOKATALI KURJI; ALY ANINMOHAMED RAJABALI NANJI; ALY NASIR SULTANALI MEGHJI of P. O. Box 46196 - 00100, Nairobi, Kenya **(740)** : None,



**(210)** : 142834 **(220)** : 28/10/2025 **(300)** : None **(511)** : 6(Metal building materials, materials of metal for railway tracks, steel pipes and tubes of metal, bolts, metal hardware, small items of metal hardware.), 9(Apparatus and instruments for controlling, transmitters, compasses for measuring, water meters), 17(Rubber pipes (plastic) and 20(Non-metallic valves) **(526)** : Registration of this mark shall give no right to the exclusive use of the words 'ARCTIC' and 'OCEAN' each separately and apart from the mark as a whole. **(730)** : ARCTIC OCEAN COMPANY LIMITED of P. O. Box 19473 - 00100, Nairobi, Kenya **(740)** : None,



**(210)** : 142854 **(220)** : 28/10/2025 **(300)** : None **(511)** : 33(Traditional spirit) **(526)** : Registration of this mark shall give no right to the exclusive use of the words 'NILOTIC', 'HERITAGE', 'SPIRIT' and the device of a 'BOTTLE' each separately and apart from the mark as a whole. 'PELELE' is a colloquial name for a Luo meaning 'Local Brew' in English. **(730)** : VITALIS OTIENO ASEWE of P. O. Box 37 - 40620, Boro, Siaya, Kenya **(740)** : None,



**(210)** : 142888 **(220)** : 30/10/2025 **(300)** : None **(511)** : 29(Meat, fish, poultry and game; meat extracts; preserved, frozen, dried and cooked fruits and vegetables; jellies, jams, compotes; eggs; milk and milk products; edible oils and fats) and 35(Advertising; business management, organization and administration; office functions) **(526)** : TASTERegistration of this mark shall give no right to the exclusive use of the words "TASTE" separately and apart from the mark as a whole **(730)** : HAPPY COW LTD Dairy processing of P. O. Box 558 - 20100, Nakuru, Kenya **(740)** : None,

## TASTE HAPPINESS

**(210)** : 142909 **(220)** : 30/10/2025 **(300)** : None **(511)** : 6(Metal Hardware) **(526)** : None Registration of this mark shall give no right to the exclusive use of the words "HARDWARE" and "WHOLESALE" each separately and apart from the mark as a whole. **(730)** : KHETIA HARDWARE LIMITED of P. O. Box 555 - 30200, Kitale, Kenya **(740)** : None,



**(210)** : 142912 **(220)** : 30/10/2025 **(300)** : None **(511)** : 11(Solar water heaters, solar lights, solar back-up systems) **(526)** : SUNRegistration of this Mark shall give no right to the exclusive use of the words "SUN", "WATER", "HEATER", "SYSTEM", "SOLAR" and the device of the "SUN" per se each separately and apart from the mark as a whole. **(730)** : SUNLAC SOLAR SYSTEMS LTD of P. O. Box 31519 - 00800, Nairobi, Kenya **(740)** : None,



**NOBLIVA AGAVE**

**(210)** : 142958 **(220)** : 31/10/2025 **(300)** : None **(511)** : 33(Alcohol beverages except beers; distilled spirits; tequila) **(526)** : AGAVERegistration of this mark shall give no right to the exclusive use of the word "AGAVE" separately and apart from the mark as a whole **(730)** : CATHERINE GATHERE MURIITHI of P. O. Box 16702 - 00620, Kenya **(740)** : None,

**(210)** : 142966 **(220)** : 31/10/2025 **(300)** : None **(511)** : 9(Apparatus and instruments for scientific or research purposes, audiovisual and information technology equipment, as well as safety and life-saving equipment.), 25(Clothing, footwear and headwear for human beings), 36(Service relating to banking and other financial transactions, financial valuation services, as well as insurance and real estate activities.) and 42(Services provided by persons in relation to the theoretical and practical aspects of complex fields of activities, for example, scientific laboratory services, engineering, computer programming, architectural services or interior design.) **(526)** : None "BUSHA" is a coined word with no English meaning. **(730)** : BUSHA DIGITAL LIMITED of P. O. Box 66513 - 00800, Westlands, Nairobi, Kenya **(740)** : Muthee and Partners LLP of P. O. Box 66513 - 00800, Nairobi, Kenya



**(210)** : 142970 **(220)** : 31/10/2025 **(300)** : None **(511)** : 41(Education; providing of training; entertainment services; betting and gambling, sporting services, music activities, mobile games and cultural activities) **(526)** : Registration of this Mark shall give no right to the exclusive use of the word "BET" separately and apart from the mark as a whole. **(730)** : AUBREY GROUP AFRICA LIMITED BETVIVO of P. O. Box 30153 - 00100, GPO, Nairobi, Kenya **(740)** : None,



**MAA Economic Bloc.**

**(210)** : 142975 **(220)** : 04/11/2025 **(300)** : None **(511)** : 41(Education; providing of training; entertainment; sporting and cultural activities) **(526)** : MAARegistration of this mark shall give no right to the exclusive use of the words "MAA", "CULTURAL" and "WEEK" each separately and apart from the mark as a whole **(730)** : MAA ECONOMIC BLOCK of P. O. Box 1995 - 00502, 88, Mbagathi Ridge, Karen, Nairobi, Kenya **(740)** : None,

**(210)** : 142976 **(220)** : 04/11/2025 **(300)** : None **(511)** : 41(Education; providing of training; entertainment; sporting and cultural activities.) **(526)** : MAARegistration of this mark shall give no right to the exclusive use of the words "MAA", "CULTURAL", "TOURISM", "FESTIVAL", the devices of "HUMAN FIGURES" and "ASSORTED MAASAI CULTURAL ARTEFACTS" each separately and apart from the mark as a whole. **(730)** : MAA ECONOMIC BLOCK of P. O. Box 1995 - 00502, 88, Mbagathi Ridge, Karen, Nairobi, Kenya **(740)** : None,



**(210)** : 142977 **(220)** : 04/11/2025 **(300)** : None **(511)** : 41(Education; providing of training; entertainment; sporting and cultural activities.) **(526)** : MAARegistration of this mark shall give no right to the exclusive use of the words "MAA", "ECONOMIC", "BLOC", the devices of "HUMAN FIGURE", a "BULL COW", an "ELEPHANT" and a "GOAT" each separately and apart from the mark as a whole. **(730)** : MAA ECONOMIC BLOCK of P. O. Box 1995 - 00502, 88, Mbagathi Ridge, Karen, Nairobi, Kenya **(740)** : None,



**(210)** : 142987 **(220)** : 04/11/2025 **(300)** : None **(511)** : 5(Diapers, sanitary pads, diapers for babies and for incontinence; sanitary preparations for personal hygiene, other than toiletries; babies' diaper-pants) **(526)** : BABYRegistration of this mark shall give no right to the exclusive use of the words "BABY" and "DIAPER" each separately and apart from the mark as a whole. **(730)** : YO'CARE HYGIENICS LIMITED of Plot No.10020, Mwembeshi Road, Chinika, Lusaka, Zambia **(740)** : CFL Advocates of P. O. Box 23555 - 00100, Nairobi, Kenya

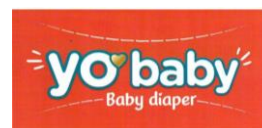

**(210)** : 143012 **(220)** : 05/11/2025 **(300)** : None **(511)** : 3(Toothpastes, skincare products, soaps, detergents), 5(Supplements (food)) and 30(Tea) **(526)** : NUTRITIONRegistration of this mark shall give no right to the exclusive use of the words "NUTRITION "and" HEALTH " each separately and apart from the mark as a whole. **(730)** : ETERNAL INTERNATIONAL HEALTH AND PRODUCTS of P. O. 2866 - 80100, Mombasa, Kenya **(740)** : None,



**(210)** : 143038 **(220)** : 06/11/2025 **(300)** : None **(511)** : 34( Cigarettes; tobacco, raw or manufactured; roll your own tobacco; pipe tobacco; tobacco products; tobacco substitutes (not for medical purposes); cigars; cigarillos; cigarette lighters for smokers; cigar lighters for smokers; matches; smokers' articles; cigarette paper; cigarette tubes; cigarette filters; pocket apparatus for rolling cigarettes; hand held machines for injecting tobacco into paper tubes; electronic cigarettes; liquids for electronic cigarettes; tobacco products for the purpose of being heated; electronic devices and their parts for the purpose of heating tobacco.) **(526)** : None **(730)** : BRITISH AMERICAN TOBACCO KENYA PLC of P. O. Box 30000 - 00100, 8 Likoni Road, Industrial Area, Nairobi, Kenya **(740)** : Iseme Kamau & Maema Advocates of P. O. Box 11866 - 00400, Nairobi, Kenya



**(210)** : 143047 **(220)** : 06/11/2025 **(300)** : None **(511)** : 41(Education; providing of training; entertainment; sporting and cultural activities) **(526)** : None **(730)** : WILLIE GICHORA of P. O. Box 63218 - 00619, Nairobi, Kenya **(740)** : None,



**(210)** : 143091 **(220)** : 10/11/2025 **(300)** : None **(511)** : 5(Herbicide, fungicides, insecticides) **(526)** : None **(730)** : SERAVA LIFESCINCES GROUP LTD of P. O. Box 46733 - 00100, Nairobi, Kenya **(740)** : None,

**SERADO**

**(210)** : 143161 **(220)** : 12/11/2025 **(300)** : None **(511)** : 35(Advertising; business management; business administration; office functions), 39(Transport; packaging and storage of goods; travel arrangement) and 43(Services for providing food and drink; temporary accommodation.) **(526)** : Registration of this mark shall give no right to the exclusive use of the words "MARA", "BAY" and "LODGE" each separately and apart from the mark as a whole. **(730)** : ELAND SWIFT LIMITED of P. O. Box 43123 - 00100, Nairobi, Kenya **(740)** : None,

**OLIVE MARA BAY LODGE**

**(210)** : 143162 **(220)** : 12/11/2025 **(300)** : None **(511)** : 35(Advertising; business management; business administration; office functions), 39(Transport; packaging and storage of goods; travel arrangement) and 43(Services for providing food and drink; temporary accommodation) **(526)** : MARARegistration of this mark shall give no right to the exclusive use of the words "MARA", "BAY" and "LODGE" each separately and apart from the mark as a whole. **(730)** : ELAND SWIFT LIMITED of P. O. Box 43123 - 00100, Nairobi, Kenya **(740)** : None,

**MARA BAY LODGE**

**(210)** : 143177 **(220)** : 13/11/2025 **(300)** : None **(511)** : 5(Pharmaceuticals, medical and veterinary preparations; sanitary preparations for medical purposes; dietetic food and substances adapted for medical or veterinary use, food for babies; dietary supplements for human beings and animals; plasters, materials for dressings; material for stopping teeth, dental wax; disinfectants

**CEFIXOL**

; preparation for destroying vermin; fungicides, herbicides.) (526) : None (730) : LABORATORY AND ALLIED LIMITED of P. O. Box 42875 - 00100, Nairobi, Kenya (740) : None,

**CEFROLAB**

(210) : 143178 (220) : 13/11/2025 (300) : None (511) : 5(Pharmaceuticals, medical and veterinary preparations; sanitary preparations for medical purposes; dietetic food and substances adapted for medical or veterinary use, food for babies; dietary supplements for human beings and animals; plasters, materials for dressings; material for stopping teeth, dental wax; disinfectants; preparation for destroying vermin; fungicides, herbicides.) (526) : None (730) : LABORATORY AND ALLIED LIMITED of P. O. Box 42875 - 00100, Nairobi, Kenya (740) : None,

**PALIETA**

(210) : 143201 (220) : 13/11/2025 (300) : None (511) : 29(Goods like coconut milk, coconut cream, tinned mushrooms, tinned tomatoes, olives, honey, dairy & non-dairy creams, soya milk, almond milk, capers in vinegar) and 30(Soy sauces, oyster sauce, fish sauce, chilli sauce, mustards, mayonnaise, tomato paste) (526) : None "PALIETA is a coined word with no particular meaning " (730) : BRIDGEWAYS GLOBAL LIMITED of P. O. Box 28441 -00200, Nairobi, Kenya (740) : None,

(210) : 143206 (220) : 14/11/2025 (300) : None (511) : 3(Toothpastes, skincare products, soaps, detergents), 5(Supplements (food)) and 30(Tea) (526) : INTERNATIONALRegistration of this mark shall give no right to the exclusive use of the word "INTERNATIONAL" separately and apart from the mark as a whole. (730) : ETERNAL INTERNATIONAL HEALTH AND PRODUCTS of P. O. 2866 - 80100, Mombasa, Kenya (740) : None,

**ETERNAL**  
International

(210) : 143228 (220) : 17/11/2025 (300) : None (511) : 4(Industrial oils and greases, wax; lubricants; dust absorbing, wetting and binding compositions; fuels and illuminants; candles and wicks for lighting.) (526) : Registration of this mark shall give no right to the exclusive use of the device of a 'FLAME' each separately and apart from the mark as a whole. (730) : LEADWAY PETROLEUM LIMITED of P. O. Box 68811 - 00622, Nairobi, Kenya (740) : None,



(210) : 143241 (220) : 17/11/2025 (300) : None (511) : 41(Betting Services) (526) : Registration of this mark shall give no right to the exclusive use of the word 'BET' separately and apart from the mark as a whole. (730) : GAME STREAM LIMITED of P. O. Box 13197 - 00200, Nairobi, Kenya (740) : None,

**BETANO**

(210) : 143249 (220) : 18/11/2025 (300) : None (511) : 30(Sauce, paste) (526) : None 'LAZAIN' is a coined word with no specific meaning in English.(730) : AYWAA FOODS LTD of P. O. Box 80114 - 97477, Mombasa, Kenya (740) : None,

**LAZAIN IT**

(210) : 143250 (220) : 18/11/2025 (300) : None (511) : 9(Batteries) (526) : GERMANRegistration of this mark shall give no right to the exclusive use of the words "GERMAN", "MAINTENANCE", "FREE", "BATTERY", the letters "I", "T" and "A" each separately and apart from the mark as a whole (730) : LIFE BEYOND of P. O. Box 80114 - 97477, Mombasa, Kenya (740) : None,



(210) : 143258 (220) : 18/11/2025 (300) : None (511) : 7(Water pump, generator set, pressure washer, welding machines, air compressor) (526) : None "HELIOS" is a quality and genuine product its efficient, durable and reliable solutions for domestic and agricultural use. (730) : PREMIER TRADING COMPANY LIMITED of P. O. Box 41578 - 00100, Nairobi, Kenya (740) : None,

**HELIOS**

**(210)** : 143262 **(220)** : 18/11/2025 **(300)** : None **(511)** : 42(Information technology (IT, T consultancy, software development, computer programming, cloud computing, web hosting, technical support) **(526)** : HOSTRegistration of this mark shall give no right to the exclusive use of the words "HOST", "PINNACLE", "SECURITY", "SPEED", "SIMPLICITY" and the device of "STARS" per se each separately and apart from the mark as a whole. **(730)** : HOST PINNACLE CLOUD LIMITED of P. O. Box 25298 - 00603, Lavington, Kenya **(740)** : None,



**(210)** : 143273 **(220)** : 19/11/2025 **(300)** : None **(511)** : 3(Airfreshner, air deodorant) **(526)** : Registration of this mark shall give no right to the exclusive use of the word 'fresh' separately and apart from the mark as a whole. 'zrak ' is a coined word with no meaning. **(730)** : BLUEMART PRODUCTS EA. LTD of P. O. Box 3988 - 00506, Nairobi, Kenya **(740)** : None,



**(210)** : 143288 **(220)** : 19/11/2025 **(300)** : None **(511)** : 3(Toothpastes, skincare products, soaps, detergents), 5(Supplements (food) and 30(Tea) **(526)** : INTERNATIONALRegistration of this mark shall give no right to the exclusive use of the words "INTERNATIONAL", "LIMITED" and the devices of "EARS OF WHEAT" and "GLOBE" each separately and apart from the mark as a whole. **(730)** : ETERNAL INTERNATIONAL HEALTH AND PRODUCTS of P. O. 2866 - 80100, Mombasa, Kenya **(740)** : None,



**(210)** : 143289 **(220)** : 19/11/2025 **(300)** : None **(511)** : 41(Gaming and betting.) and 42(Computer programming; Computer software design; Rental of computer software; Rental of computer software and programs; Rental and maintenance of computer software; Creating and maintaining websites; Creating and maintaining web sites for others; Providing information on computer technology and programming via a web site; Maintenance of computer software; Updating and maintenance of computer software.) **(526)** : None **(730)** : BELARONDA LIMITED of Intershore Chambers, P.O. Box 4342, Road Town, Tortola, Virgin Islands (British) **(740)** : CFL Advocates of P. O. Box 23555 - 00100, Nairobi, Kenya

**HARAKABET**

**(210)** : 143293 **(220)** : 19/11/2025 **(300)** : None **(511)** : 1(Chemicals for use in industry, science and photography, as well as in agriculture, horticulture and forestry; unprocessed artificial resins, unprocessed plastics; fire extinguishing and fire prevention compositions; tempering and soldering preparations; substances for tanning animal skins and hides; adhesives for use in industry; putties and other paste fillers; compost, manures, fertilizers; biological preparations for use in industry and science; bio-fertilizers; bio-stimulants for plants; biochar; grafting wax for trees.), 4(Fuels and illuminants; biomass fuel; wood for use as fuel; firelighters [kindling wood]; fuel products made from woodchips; woodchips for smoking and flavouring foods; wood pellet fuel; charcoal [fuel]; coal dust [fuel].), 19(Materials, not of metal, for building and construction; rigid pipes, not of metal, for building; transportable buildings, not of metal; building materials of wood; wood; poles of non-metallic materials; non-metal utility poles; planks of wood for building; non-metal roof trusses; wood panelling; wood boards; wood sheeting; wood posts; wood joints; wood beams; wood rafters; wood flooring; wooden shutters; wooden doors; wooden

**SUNBIRD FORESTS  
COMPANY**

---

window frames; wooden door frames.), 20(Furniture, mirrors, picture frames; containers, not of metal, for storage or transport; non-metallic crates and pallets; wooden crates; wooden pallets; wood boxes; wood barrels; wooden furniture; wooden panels for furniture; wooden beds ; wooden blinds; wooden ladders.), 36(Financial, monetary and banking services; insurance services; real estate services.) and 44(Agriculture, aquaculture, horticulture and forestry services; advisory and consultancy services relating to agriculture, horticulture and forestry; forest habitat restoration; planting of trees; reforestation services; transplanting of trees; tree surgery; tree nurseryman services; information services relating to agriculture, horticulture and forestry; rental of equipment for agriculture, horticulture and forestry.) (526) : Registration of this mark shall give no right to the exclusive use of the words 'FORESTS' and 'COMPANY' each separately and apart from the mark as a whole. (730) : NEW FORESTS COMPANY HOLDINGS LIMITED a corporation organized and existing under the laws of Mauritius of 2nd Floor Suite 122, Harbour Front Building, President John Kennedy Street, Port Louis, Mauritius (740) : Perpetua N Law Advocates t/a Von Seidels Kenya of P. O. Box 785 - 00618, Ruaraka, Nairobi, Kenya

---

(210) : 143298 (220) : 19/11/2025 (300) : None (511) : 41(Entertaining, cultural activities, recreational activities; live events; music events; festivals; social entertainmrent; hosting and organizing events at campsite or similar venues) and 43(Services of providing food and drink; temporary accommodation; campsites; restaurants and bar services hospitality services; event hosting related to tourism and leisure) (526) : None "WOZA WOZA" is a Zulu word that translates to "Let's Go" in English language. (730) : JENNIFER MARIA JOHNSON of P. O. Box 624, Ukunda, Kwale, Kenya (740) : None,

---

**WOZA WOZA**

(210) : 143299 (220) : 19/11/2025 (300) : None (511) : 5(Pharmaceutical preparations) (526) : CRegistration of this mark shall give no right to the exclusive use of the letter "C" separately and apart from the mark as a whole. "EFFOVIT-C" is a coined word with no meaning. (730) : ULTIMAL MULTINATIONAL LIMITED of P. O. Box 132 - 60200, Kenya (740) : None,

---

**EFFOVIT-C**

(210) : 143389 (220) : 21/11/2025 (300) : None (511) : 9(Scientific, research, navigation, surveying, photographic, cinematographic, audiovisual, optical, weighing, measuring, signalling, detecting, testing, inspecting, life-saving and teaching apparatus and instruments; apparatus and instruments for conducting, switching, transforming, accumulating, regulating or controlling the distribution or use of electricity; apparatus and instruments for recording, transmitting, reproducing or processing sound, images or data; recorded and downloadable media, computer software, blank digital or analogue recording and storage media; mechanisms for coin-operated apparatus; cash registers, calculating devices; computers and computer peripheral devices; diving suits, divers' masks, ear plugs for divers, nose clips for divers and swimmers, gloves for divers, breathing apparatus for underwater swimming; fire-extinguishing apparatus.), 36(Financial, monetary and banking services; insurance services; real estate services.) and 42(Scientific and technological services and research and design relating thereto; industrial analysis, industrial research and industrial design services; quality control and authentication services; design and development of computer hardware and software.) (526) : None 'EKOZIZI' is a coined word with no specific meaning in English.(730) : JAMES CHRISTOPHER MEASURES of P. O. Box 195 -80108, Kilifi, Kenya (740) : None,

---

**EKOZIZI**

**(210)** : 143398 **(220)** : 21/11/2025 **(300)** : None **(511)** : 1(Chemicals for use in industry, science and photography, as well as in agriculture, horticulture and forestry; unprocessed artificial resins, unprocessed plastics; fire extinguishing and fire prevention compositions; tempering and soldering preparations; substances for tanning animal skins and hides; adhesives for use in industry; putties and other paste fillers,] compost, manures, fertilizers; biological preparations for use in industry and science.), 2(Paints, varnishes, lacquers; Preservatives against rust and against deterioration of wood; Colorants, dyes; Inks for printing, marking and engraving; Raw natural resins; Metals in foil and powder form for use in painting, decorating, printing and art.),16(Paper and cardboard; printed matter, bookbinding material; photographs; stationery and office requisites, except furniture; adhesives for stationery or household purposes; drawing materials and materials for artists; paintbrushes; instructional and teaching materials; plastic sheets, films and bags for wrapping and packaging printers' type, printing blocks.), 19(Building materials (non-metallic); non-metallic rigid pipes for building; asphalt, itch, and bitumen; non-metallic transportable buildings; monuments, not of metal), 35(Advertising; business management, organization and administration; office functions.), 37(Construction services; installation and repair services; mining extraction, oil and gas drilling) and 42(Scientific and technological services and research and design relating thereto; industrial analysis, industrial research and industrial design services; quality control and authentication services; design and development of computer hardware and software.) **(526)** : Registration of this mark shall give no right to the exclusive use of the words "PAINT", "BUILDS" and "AFRICA" each separately and apart from the mark as a whole. **(730)** : KANSAI PLASCON KENYA LTD of P. O. Box 18011 - 00500, Nairobi, Kenya **(740)** : Mura Muiruri & Company LLP of P. O. Box 49153 - 00100, Nairobi, Kenya



**(210)** : 143412 **(220)** : 21/11/2025 **(300)** : None **(511)** : 33(Alcoholic beverages (except beer)) and 41(Education; Providing of training and information services; Entertainment; provision of entertainment information; planning or arrangement of showing musical and cultural performances, music concerts, events, festivals and activities; arranging, conducting and organization of events, namely musical performances, music concerts and festivals and other musical and cultural performances, events and activities; presentation of musical performance; production, organisation and staging of competitions, games, quizzes, fun days and musical events; organisation, presentation and production of shows and live performances; exhibitions) **(526)** : Registration of this mark shall give no right to the exclusive use of the word 'TEQUILA' separately and apart from the mark as a whole. **(730)** : DIAGEO MEXICO COMERCIALIZADORA, S.A. de C.V. of Ejercito Nacional 843-B Piso 2, Torre Paseo, Acceso B, Colonia Granada C.P. 11520 Mexico D.F., Mexico **(740)** : Coulson Harney LLP of P. O. Box 10643 - 00100, Nairobi, Kenya

**TEQUILA ISLAND**

**(210)** : 143425 **(220)** : 24/11/2025 **(300)** : None **(511)** : 5(Pharmaceuticals, medical and veterinary preparations; sanitary preparations for medical purposes; dietetic food and substances adapted for medical or veterinary use, food for babies; dietary supplements for human beings and animals; plasters, materials for dressings; material for stopping teeth, dental wax; disinfectants; preparations for destroying vermin; fungicides, herbicides) **(526)** : None **(730)** : EASTSTAR PHARMACY LTD of P. O. Box 6393 - 00200, Nairobi, Kenya **(740)** : None,

**INFADERM**

**(210)** : 143428 **(220)** : 24/11/2025 **(300)** : None **(511)** : 12(Baby care seats, baby tricycles, kids bicycles, baby ride on cars, kids electric cars & bikes) and 20(Baby beds, baby strollers, baby walkers, baby playpens, baby bathtubs, baby potties, baby high chairs) **(526)** : Registration of this mark shall give no right to the exclusive use of the word 'BABY' separately and apart from the mark as a whole. **(730)** : JESH IMPEX LIMITED of P. O. Box 1806 - 00606, Nairobi, Kenya **(740)** : None,

### DIVINE BABY

**(210)** : 143438 **(220)** : 24/11/2025 **(300)** : None **(511)** : 41(Education; providing of training; entertainment; sporting and cultural activities.) **(526)** : RIARARegistration of this mark shall give no right to the exclusive use of the words "RIARA", "SCHOOLS", the numerals "1", "4", "7", "9" and the letter "R" per se each separately and apart from the mark as a whole. The mark is proceeding in series. **(730)** : RIARA GROUP OF SCHOOLS LIMITED of P. O. Box 21389 - 00505, Nairobi, Kenya **(740)** : Kieti Law LLP of P. O. Box 22602 - 00505, Nairobi, Kenya



**(210)** : 143439 **(220)** : 24/11/2025 **(300)** : None **(511)** : 41(Education; providing of training; entertainment; sporting and cultural activities) **(526)** : RIARARegistration of this mark shall give no right to the exclusive use of the words "RIARA", "SCHOOLS", the numerals "1", "4", "7", "9" and the letter "R" per se each separately and apart from the mark as a whole. The mark is proceeding in series. **(730)** : RIARA GROUP OF SCHOOLS LIMITED of P. O. Box 21389 - 00505, Nairobi, Kenya **(740)** : Kieti Law LLP of P. O. Box 22602 - 00505, Nairobi, Kenya



**(210)** : 143511 **(220)** : 28/11/2025 **(300)** : None **(511)** : 1(Fertilizer) **(526)** : Registration of this mark shall give no right to the exclusive use of the words "SUPAGROW" and "BOOSTER" each separately and apart from the mark as a whole. **(730)** : JOJEMI CHEMICALS of P. O. Box 953 - 00600, Nairobi, Kenya **(740)** : None,

### JOJEMI SUPAGROW BOOSTER

**(210)** : 143520 **(220)** : 28/11/2025 **(300)** : None **(511)** : 36(Insurance; financial affairs; monetary affairs; real estate affairs.) **(526)** : None "TAGOPTION" is a coined word with no specific meaning in English. **(730)** : CANDY BUZZ LIMITED of P. O. Box 75376 - 20103, Eldama Ravine, Kenya **(740)** : None,

### Tagoption

**(210)** : 143521 **(220)** : 28/11/2025 **(300)** : None **(511)** : 9(Scientific, nautical, surveying, photographic, cinematographic, optical, weighing, measuring, signaling, checking (supervision), life-saving and teaching apparatus and instruments; electric and electronic apparatus and hardware, equipment for the storage and transmission of data and information for use in relation to banking, financial, insurance and general commercial transactions, including those conducted online via the Internet or a computer network, or by telephone or cellular telephone; software, systems, devices and platforms used to enable and facilitate electronic banking, financial, insurance or other commercial transactions, including those via the Internet or a computer network, or by telephone or cellular telephone; including data processing equipment and software for use in relation to banking and financial services including data processing equipment and software; downloadable electronic publications; apparatus and equipment for the electronic transfer of and/or financial data; telecommunication equipment; automated teller machines; money dispensing machines, electronic fund transfer, payment or point of sale apparatus, machines and terminals; card and bar code scanners; magnetic and magnetically encoded cards; programmable cards; smart cards; cards bearing coded data in magnetic form; cards bearing data for use in computers; cards bearing coded data in punched-out form; cards bearing data for use in data processing apparatus; cards bearing data for use in data storage apparatus; cards bearing electronically recorded data; cards bearing integrated circuits; cards bearing

### WHATMATTERS

---

magnetic or encoded data for input; cards bearing micro-chips and computer cards containing chips; credit, charge, debit and/or cash cards; prepayment cards [encoded]; loyalty or gift cards [encoded], readers, scanners, parts and fittings for the aforementioned goods), 16(Paper, cardboard and goods made from these materials, not included in other classes; printed matter; books, magazines, manuals newspapers, newsletters, pamphlets; bookbinding material; photographs; stationery; adhesives for stationery or household , purposes; artists' materials; paint brushes; typewriters, office requisites (except furniture); instructional and teaching materials (except apparatus); wrapping and packaging materials; plastic materials for packaging (not included in other classes); printers' type; printing blocks; printed publications; newsletters, reviews and publications; documentation relating to financial, banking, insurance and investment services or transactions; advertising materials; brochures, vouchers, cheques, cheque books; cheque book holders: paying-in books; bank cards, cash cards, cheque cards, debit cards, credit cards, charge cards, loyalty or gift cards all being other than encoded or magnetic cards ), 35(Advertising; business management; business administration; office functions; facilitation of commercial and business transactions, including those conducted online via the Internet or a computer network, or by telephone or cellular telephone; business strategy services; business appraisal and analysis services; database management services; provision of business and commercial advice and information provided by telephone or provided online from a computer database, computer network, global computer network or the Internet; business planning; business strategy services, business appraisals; business management assistance; business support; accounting; economic forecasting and analysis for business purposes; profit and cash flow forecasting, analysis and planning, all being economic forecasting services; personnel management and employment consultancy; database management services, data processing, data verification and file management; computerized business information storage and retrieval; credit card registration services; procurement of goods and services on behalf of businesses; purchasing of goods and services for other businesses; business administration services for the processing of sales and transactions made on a global computer network or the Internet; the bringing together, for the benefit of others, of a variety of goods including but not limited to, business equipment, enabling customers to conveniently view and purchase those goods from a computer network website or an Internet website; offering for sale and the sale of goods in the retail and wholesale trade; customer loyalty reward schemes, customer care services; advisory, consultancy, information and helpline services relating to all of the aforesaid services ancillary or related to the aforementioned all in class 35.), 36(Insurance products and services; financial affairs; monetary affairs; real estate affairs; banking services; payment facilitation services, facilitation and rendering of banking and financial transactions, including those rendered online via the Internet or computer network, or by telephone or cellular telephone; services ancillary and related to all of the foregoing, all in class 36), 38(Telecommunications and communications services; providing user access to computer networks or the Internet for purposes of facilitating commercial, banking or financial transactions and electronic payments; providing telecommunications connections to the Internet or data bases for purposes of facilitating commercial, banking or financial transactions and electronic payments services ancillary and related to all of the foregoing, all in class 38), 41(Education; providing of training; entertainment; sporting and cultural activities; television entertainment; organising and conducting of competitions; publication

---

of printed matter, services ancillary and related to all of the foregoing, all in class 41) and 42(Scientific and technological services and research and design relating thereto; industrial analysis and research services; IT services, design and development of computer hardware and software and computer systems; operation of websites and online transactional platforms; rental of computer hardware and software; leasing of access time to computer database; advisory, information, evaluations, consultancy services; services ancillary and related to all of the foregoing, all in class 42.) (526) : None (730) : THE STANDARD BANK OF SOUTH AFRICA LIMITED Incorporated in South Africa of 5 Simmonds Street, Johannesburg, 2001, Gauteng, South Africa (740) : Coulson Harney LLP of P. O Box 10643 - 00100, Nairobi, Kenya

(210) : 143545 (220) : 01/12/2025 (300) : None (511) : 16(Packaging paper) (526) : KHAKIRegistration of this mark shall give no right to the exclusive use of the word "KHAKI" separately and apart from the mark as a whole. The English translation of the Swahili word "CHUI" is "Leopard". (730) : DUNE PACKAGING LIMITED of P. O. Box 45310 - 00100, Station Road, Thika, Kenya (740) : None,

KHAKI CHUI



(210) : 143547 (220) : 01/12/2025 (300) : None (511) : 16(Packaging paper) (526) : KHAKIRegistration of this mark shall give no right to the exclusive use of the word "KHAKI" separately and apart from the mark as a whole. (730) : DUNE PACKAGING LIMITED of P. O. Box 45310 - 00100, Thika, Kenya (740) : None,

KHAKI SPEED



(210) : 143548 (220) : 01/12/2025 (300) : None (511) : 16(Packaging paper) (526) : KHAKIRegistration of this mark shall give no right to the exclusive use of the word "KHAKI" separately and apart from the mark as a whole. (730) : DUNE PACKAGING LIMITED of P. O. Box 45310 - 00100, Thika, Kenya (740) : None,

KHAKI TIGER



(210) : 143549 (220) : 01/12/2025 (300) : None (511) : 16(Packaging Paper) (526) : Registration of this mark shall give no right to the exclusive use of the word "KHAKI" separately and apart from the mark as a whole The English translation of the Swahili word "TWIGA" is "GIRAFFE". (730) : DUNE PACKAGING LIMITED of P. O. Box 45310 - 00100, Thika, Kenya (740) : None,

KHAKI TWIGA



(210) : 143550 (220) : 01/12/2025 (300) : None (511) : 16(Packaging paper) (526) : KHAKIRegistration of this mark shall give no right to the exclusive use of the word "KHAKI" separately and apart from the mark as a whole The English translation of the Swahili word "NDOVU" is "ELEPHANT". (730) : DUNE PACKAGING LIMITED of P. O. Box 45310 - 00100, Thika, Kenya (740) : None,

KHAKI NDOVU



(210) : 143561 (220) : 01/12/2025 (300) : None (511) : 43(Services for providing food and drink; temporary accommodation) (526) : Registration of this mark shall give no right to the exclusive use of the word "RESORT" and "PARKISITE" each separately and apart from the mark as a whole. 'SAIWA' means a Statunga Water Antelope. (730) : DANIEL MOGUSU of P. O. Box 8673 - 00100, Kenya (740) : None,



(210) : 143562 (220) : 01/12/2025 (300) : None (511) : 18(Backpacks, luggage, bags, Leather briefcases, leather wallets, leather bags, leather pouches, leather key cases, leather travel bags.) (526) : None "YIDA" is a coined word with no meaning. (730) : YIDA LUGGAGE COMPANY LIMITED of P. O. Box 36782 - 00200, Kenya (740) : None,

YIDA

(210) : 143564 (220) : 01/12/2025 (300) : None (511) : 35(Advertising; business management, organization and administration; office functions.) (526) : Registration of this mark shall give no right to the exclusive use of the word 'KENYA' separately and apart from the mark as a whole. (730) : KENYA TOURISM BOARD of P. O. Box 30630 - 00100 , Nairobi, Kenya (740) : None,

## Magical Kenya "The Origin of Wonder"

(210) : 143591 (220) : 02/12/2025 (300) : None (511) : 30(Coffee, tea, cocoa and artificial coffee; Rice; Tapioca and sago; Flour and preparations made from cereals; Bread, pastry and confectionery; Edible ices; Sugar, honey, treacle; Yeast, baking-powder; Salt; Mustard; Vinegar, sauces condiments; Spices; Ice ) (526) Registration of this mark shall give no right to the exclusive use of the words "SIMA", "POA", "BEST", the letters "I" and "O" each separately and apart from the mark as a whole. The English translation of the Kiswahili words "SIMA" and 'POA' are 'Cool Maize Meal' respectively.(730) Applicant: HAYAT FLOUR MILLS LIMITED of P. O. Box 90355-80100, Mombasa, Kenya (740) Address for correspondence: None,

**SIMA POA**  
BEST FOR YOU!

(210) : 143592 (220) : 02/12/2025 (300) : None (511) : 30(Coffee, tea, cocoa and artificial coffee; Rice; Tapioca and sago; Flour and preparations made from cereals; Bread, pastry and confectionery; Edible ices; Sugar, honey, treacle; Yeast, baking-powder; Salt; Mustard; Vinegar, sauces condiments; Spices; Ice) (526) : None The English translation of the Taita word "ABAA" is "FRIEND". The English translation of the Swahil words "HAPA" and "UMEFIKA" is "Here" and "You have reached" respectively. (730) : HAYAT FLOUR MILLS LIMITED of P. O. Box 90355 - 80100, Mombasa, Kenya (740) : None,

**Abaa**  
Hapa Umefika!

(210) : 143599 (220) : 03/12/2025 (300) : None (511) : 30(Rice, flour and preparations made from cereals) (526) : NICE Registration of this mark shall give no right to the exclusive use of the words "NICE", "EXTRA", "PREMIUM" and "ORIGINAL" each separately and apart from the mark as a whole. (730) : NICE SUPERMARKET LTD of P. O. Box 271, Wang'uru, Kenya (740) : None,

**NICE**  
Extra  
PREMIUM  
100%

(210) : 143614 (220) : 03/12/2025 (300) : None (511) : 35(Advertising; business management; business administration; office functions), 38(Telecommunications) and 41(Education; providing of training; entertainment; sporting and cultural activities) (526) : STAGE Registration of this mark shall give no right to the exclusive use of the words "STAGE", "PASS", "AUDIO", "VISUAL", "CREATIVE SOLUTIONS" and "TECHNICAL EXCELLENCE" each separately and apart from the mark as a whole. (730) : STAGEPASS AUDIO VISUAL LIMITED c/o JACKSON'S LAW PARTNERS ADVOCATES of P. O. Box 2717 - 00100, 5th Floor, Finance House, Loita Street, Nairobi, Kenya (740) : Jackson's Law Partners Advocates of P. O. Box 2717 - 00100, Nairobi

**STAGEPASS** AUDIO VISUAL  
Creative Solutions. Technical Excellence.

(210) : 143646 (220) : 04/12/2025 (300) : None (511) : 39(Transport, delivery and distribution of goods.) (526) : TRANSPORT Registration of this mark shall give no right to the exclusive use of the word "TRANSPORT" and the acronym "LTD" each separately and apart from the mark as a whole "DAKAWOU" is a coined word. (730) : DAKAWOU TRANSPORT LTD of P. O. Box 28934 - 00100, Off Mombasa Road, Nairobi, Kenya (740) : None,

**DAKAWOU TRANSPORT LTD.**  
*exceeding expectations!*

(210) : 143658 (220) : 04/12/2025 (300) : None (511) : 35(Business administration) (526) : GROUP Registration of this mark shall give no right to the exclusive use of the word "GROUP", letter "S" and the device of a "MAP OF AFRICA" each separately and apart from the mark as a whole. (730) : AFRI S GROUP PTE. LTD of P. O. Box 652 - 50100, International Plaza, Kenya (740) : None,

**S GROUP**

(210) : 143666 (220) : 04/12/2025 (300) : None (511) : 5(Plant protein supplement) (526) : PROTEINRegistration of this mark shall give no right to the exclusive use of the word "PROTEIN", the symbol "+" and the device of a "PLANT" each separately and apart from the mark as a whole. (730) : CINDY PROTEIN FEED of P. O. Box 0710212375 - 00100, Nairobi, Kenya (740) : None,



(210) : 143668 (220) : 04/12/2025 (300) : None (511) : 5(Pharmaceutical preparations) (526) : AGENCIESRegistration of this mark shall give no right to the exclusive use of the words "AGENCIES", "LIMITED", the acronym "LTD" and letter "G" each separately and apart from the mark as a whole. (730) : GOODMAN AGENCIES LTD Importation and distribution of human and veterinary medicines of P. O Box 38823 - 00623, Goodman Building, Westlands along Waiyaki Way, Nairobi, Kenya (740) : None,



(210) : 143678 (220) : 04/12/2025 (300) : None (511) : 25(Clothing, footwear, headwear) (526) : None (730) : ABIBAS LIMITED of P. O. Box 102127 - 00101, Nairobi, Kenya (740) : None,



(210) : 143695 (220) : 05/12/2025 (300) : None (511) : 3(Retail store services and online retail services for cosmetics, skincare preparation, beauty products and related accessories.), 35(Non-medicated cosmetics and skincare preparations; sunscreens; facial cleansers; moisturisers; serums; toners; lotions; creams; masks; scrubs; and other Preparations for skin and body care.) and 44(Beauty and Skincare consultation services; skincare analysis services; in-person dermatologist consultation services; beauty care advisory services; providing skincare treatment recommendations.) (526) : Registration of this mark shall give no right to the exclusive use of the words "BANDARI" , "BEAUTY" and letter "B" each separately and apart from the mark as a whole "BANDARI" means "Port" and is derived from the applicants' founder family name. (730) : BANDARI BEAUTY LIMITED of P. O. Box 42854, Green House Mall, Ngong Road, Nairobi, Kenya (740) : None,



(210) : 143711 (220) : 08/12/2025 (300) : None (511) : 41(Education; providing of training; entertainment; sporting and cultural activities.) (526) : BEAUTYRegistration of this mark shall give no right to the exclusive use of the words "BEAUTY" and "COLLEGE" each separately and apart from the mark as a whole "BIMZ" is an invented word without meaning in any language. (730) : JEFFREY WILLIAMS; JUSTINE WILLIAMS of P. O. Box 10680 - 00100, Westlands Business Park, Nairobi, Kenya (740) : None,



(210) : 143722 (220) : 09/12/2025 (300) : None (511) : 29(Milk products) (526) : SOLAIRegistration of this mark shall give no right to the exclusive use of the words "SOLAI", "HIGHLANDS", "SHAKE & GO", "LEMON", "YOGHURT" and the devices of "LEMON FRUITS" each separately and apart from the mark as a whole. (730) : KENSALT LIMITED of P. O. Box 50315 - 00100, Nairobi, Kenya (740) : None,

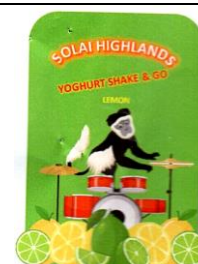

(210) : 143732 (220) : 09/12/2025 (300) : None (511) : 9(Computer programs, downloadable; Data processing apparatus; Stands adapted for tablet computers; Computer memory devices; Computers for use In data management; computer programs, recorded; computer software platforms, recorded or downloadable; downloadable software applications for mobile phones; Computer software, downloadable; stands adapted for laptops; Computer software, recorded; Computer software applications, downloadable; Quantity indicators; holders adapted for mobile telephones and smartphones; holders adapted for



mobile phones; in-car telephone handset cradles; electric sockets; electronic control apparatus; Snowboarding helmets; eyeglasses; battery charge devices; Dry cells.) (526) : 'AIMA' is the spelling of a Chinese character and does not have a specific meaning in English. (730) : AIMA TECHNOLOGY GROUP CO., LTD Incorporated in The People's Republic of China of No. 5 Aima Road, South Zone of Jinghai Economic Development Zone Tianjin, China (740) : CFL Advocates of P. O. Box 23555 - 00100, Nairobi, Kenya

(210) : 143753 (220) : 10/12/2025 (300) : None (511) : 5(Pharmaceuticals, medical and veterinary preparations; sanitary preparations for medical purposes; dietetic food and substances adapted for medical or veterinary use, food for babies; dietary supplements for human beings and animals; plasters, materials for dressings; material for stopping teeth, dental wax; disinfectants; preparations for destroying vermin; fungicides, herbicides) (526) : CREAMRegistration of this mark shall give no right to the exclusive use of the word "CREAM" separately and apart from the mark as a whole (730) : EASTSTAR PHARMACY LTD of P. O. Box 6393 - 00200, Nairobi, Kenya (740) : None,

NEONURA CREAM

(210) : 143757 (220) : 10/12/2025 (300) : None (511) : 33(Alcoholic beverages, except beers; alcoholic preparations for making beverages.) (526) : None (730) : NAMAQUA WINES [RF] (PTY) LTD of 17 Circle Road, Vrefendal, Western Cape, South Africa, 8160, South Africa (740) : Iseme, Kamau & Maema Advocates of P. O. Box 11866 - 00400, Nairobi, Kenya

RAINDANCE

(210) : 143770 (220) : 10/12/2025 (300) : None (511) : 42(Providing online platforms and software as a service (Saas) featuring messaging, communication, AI-assisted conversation, and online booking services via web and mobile applications.) (526) : Registration of this mark shall give no right to the exclusive use of the word "CHAT" and the numeral "7" each separately and apart from the mark as a whole. (730) : SILVANUS AGORO ABWAO of P. O. Box 76, Bondo, Kenya (740) : None,



(210) : 143775 (220) : 10/12/2025 (300) : None (511) : 14(Jewellery items such as necklaces, rings, earrings, bracelets, hair and head ornaments, bangles pendants, anklets, watches, pins worn for beauty, brooches, cufflinks, hair pins, tiaras and other beauty jewelleryes) (526) : BEAUTIFULRegistration of this mark shall give no right to the exclusive use of the words "BEAUTIFUL", "BOLD" and "AFRO" each separately and apart from the mark as a whole "ARO" is a coined word with no meaning in any language. (730) : WANG TIAN of P. O. Box 7595 - 00200, Nairobi, Kenya (740) : None,

ARØ

BEAUTIFUL. BOLD. AFRO.

(210) : 143777 (220) : 10/12/2025 (300) : None (511) : 43(Hotel accommodation services; temporary accommodation; hotel reservations; restaurant and café services; rental of meeting rooms.) (526) : VIENNARegistration of this mark shall give no right to the exclusive use of the words "VIENNA" and "HOTEL" each separately and apart from the mark as a whole. The translation of the Chinese characters is "VIENNA HOTEL". (730) : ALTERIX COMPANY LIMITED of P. O. Box 1916, Sifa Towers, Kilimani, Nairobi, Kenya (740) : None,



(210) : 143792 (220) : 11/12/2025 (300) : None (511) : 35(Advertising; business management; business administration; office functions, grouping together of various goods for others and wholesale and retail services) (526) : None (730) : MONTE HORIZON VENTURES of P. O. Box 17671 -00100, Nairobi, Kenya (740) : None,

SKYHOME

---

**(210)** : 143806 **(220)** : 11/12/2025 **(300)** : None **(511)** : 36(Financial services, including financial sponsorship services; monetary affairs; real estate affairs; insurance services; services ancillary and related to all of the foregoing all in class 36.) and 41(Education; providing of training; entertainment; sporting and cultural activities, arranging, conducting, and hosting of sporting events and competitions; services ancillary and related to all of the foregoing all in class 41.) **(526)** : RUNRegistration of this mark shall give no right to the exclusive use of the word "RUN" separately and apart from the mark as a whole. **(730)** : HOLLARD HOLDINGS (PROPRIETARY) LIMITED of 22 Oxford Road, Parktown, Johannesburg, Gauteng, South Africa **(740)** : ENSafrica NBMA Advocates LLP of P. O. Box 12342 - 00100, Nairobi, Kenya

---

## DAREDEVIL RUN

**(210)** : 143831 **(220)** : 15/12/2025 **(300)** : None **(511)** : 5(Pharmaceutical and veterinary preparations; sanitary preparations for medical purposes; dietetic food and substances adapted for medical or veterinary use, food for babies; dietary supplements for humans and animals; plasters, materials for dressings; material for stopping teeth, dental wax; disinfectants; preparations for destroying vermin; fungicides, herbicides; sanitary preparations for personal hygiene, other than toiletries; diapers for babies and for incontinence; deodorants, other than for human beings or for animals; medicated shampoos, soaps, lotions and dentifrices; dietary supplements intended to supplement a normal diet or to have health benefits; meal replacements and dietetic food and beverages adapted for medical or veterinary use.), 9(Scientific, nautical, surveying, photographic, cinematographic, optical, weighing, measuring, signalling, checking (supervision), life-saving and teaching apparatus and instruments; apparatus and instruments for conducting, switching, transforming, accumulating, regulating or controlling electricity; apparatus for recording, transmission or reproduction of sound or images; magnetic data carriers, recording discs; compact discs, DVDs and other digital recording media; mechanisms for coin-operated apparatus; cash registers, calculating machines, data processing equipment, computers; computer software; fire-extinguishing apparatus; apparatus and instruments for scientific research in laboratories; training apparatus and simulators, for example, resuscitation mannequins, simulators for the steering and control of vehicles; apparatus and instruments for controlling and monitoring aircraft, watercraft and unmanned vehicles, for example, navigational instruments, transmitters, compasses for measuring, GPS apparatus, automatic steering apparatus for vehicles; safety and security apparatus and instruments, for example, safety nets, signalling lights, traffic-light apparatus, fire engines, sound alarms, security tokens being encryption devices; clothing that protects against serious or life-threatening injuries, for example, clothing for protection against accidents, irradiation and fire, bullet-proof clothing, protective helmets, head guards for sports, mouth guards for sports, protective suits for aviators, knee-pads for workers; optical apparatus and instruments, for example, eyeglasses, contact lenses, magnifying glasses, mirrors for inspecting work, peepholes; magnets; smart watches, wearable activity trackers; joysticks for use with computers, other than for video games, virtual reality headsets, smart glasses; eyeglass cases, cases for smartphones, cases especially made for photographic apparatus and instruments; automated teller machines

---



, invoicing machines, material testing instruments and machines; batteries and chargers for electronic cigarettes; electric and electronic effects units for musical instruments; laboratory robots, teaching robots, security surveillance robots, humanoid robots with artificial intelligence for use in scientific research.), 10(Surgical, medical, dental and veterinary apparatus and instruments, artificial limbs, eyes and teeth; orthopedic articles; suture materials; support bandages, orthopaedic bandages; special clothing for medical purposes, for example, compression garments, stockings for varices, strait jackets, orthopaedic footwear; articles, instruments and devices for menstruation, contraception and childbirth, for example, menstrual cups, pessaries, condoms, childbirth mattresses, forceps; therapeutic and prosthetic articles and devices for implantation made of artificial or synthetic materials, for example, surgical implants comprised of artificial materials, artificial breasts, brain pacemakers, biodegradable bone fixation implants; furniture especially made for medical purposes, for example, armchairs for medical or dental purposes, air mattresses for medical purposes, operating tables.), 35(Advertising; business management; business administration; office functions; advertising, marketing and promotional services, for example, distribution of samples, development of advertising concepts, writing and publication of publicity texts; shop window dressing; public relations services; production of teleshopping programmes; organization of trade fairs and exhibitions for commercial or advertising purposes; search engine optimization for sales promotion; commercial assistance services, for example, personnel recruitment, negotiation of business contracts for others, cost price analysis, import-export agency services.) and 44(Medical services; veterinary services; hygienic and beauty care for human beings or animals; agriculture, horticulture and forestry services; hospital services; telemedicine services; dentistry, optometry and mental health services; medical clinic services and medical analysis services for diagnostic and treatment purposes provided by medical laboratories, such as x-ray examinations and taking of blood samples; therapy services, for example, physiotherapy and speech therapy; pharmacy advice and preparation of prescriptions by pharmacists; blood bank and human tissue bank services; convalescent home and rest home services; dietary and nutritional advice; health spa services; artificial insemination and in vitro fertilization services; animal breeding; animal grooming; body piercing and tattooing; services relating to gardening, for example, plant nursery services, landscape design, landscape gardening, lawn care; services relating to floral art, for example, flower arranging, wreath making; weed killing, vermin and pest control for agriculture, aquaculture, horticulture and forestry.) (526) : Registration of this mark shall give no right to the exclusive use of the Words "AFYA", "DIRECT", "HEALTH" and letter "A" per se each separately and apart from the mark as a whole. The english translation of the kiswahili word "AFYA" is "Health". (730) : PHARMAGRIDE AFRICA LIMITED of P. O. Box 44213 - 00100, Nairobi, Kenya (740) : None,

(210) : 143860 (220) : 16/12/2025 (300) : None (511) : 35(Advertising, marketing and promotional services; influencer marketing; production of advertising content for others; sponsorship marketing and brand partnerships; social-media marketing consultancy; promotion of third-party goods and services.) and 41(Entertainment services; production, presentation and distribution of audiovisual content; film and video production; providing online non-downloadable videos and publications; photography services; arranging and hosting adventure-themed entertainment experiences.) (526) : Registration of this mark

**96 LOST**

shall give no right to the exclusive use of the numerals "6" and "9" each separately and apart from the mark as a whole (730) : 96 LOST ADVENTURES LIMITED of P. O. Box 28746 - 00100, Mombasa, Kenya (740) : None,

(210) : 143891 (220) : 17/12/2025 (300) : None (511) : 9(Downloadable computer software; downloadable mobile applications for electronic financial transactions; downloadable software for digital wallets; downloadable blockchain-based software applications; computer programs for processing financial and event data; downloadable software for secure cryptographic transactions; software for use with distributed ledger technology.), 36(Financial services; electronic financial transaction services; provision of financial information; digital financial platforms; online financial services facilitated via distributed ledger technology.) and 42(Software as a service (SaaS); blockchain-based software platforms; decentralized application development; hosting of digital platforms; cryptographic and distributed ledger technology services.) (526) : None The mark is restricted to the colours "YELLOW", "RED" and "GREEN". The mark proceeds in series. (730) : MO COWRYS INTERNATIONAL LIMITED of P. O. Box 62003 - 00200, Nairobi, Kenya (740) : None,



(210) : 143896 (220) : 18/12/2025 (300) : None (511) : 31(Raw and unprocessed agricultural products, seeds and livestock) (526) : EXCELLENCERegistration of this mark shall give no right to the exclusive use of the words "EXCELLENCE", "AGRICULTURE", the letters "A", "C", "D" and the devices of "TREE" and "TRACTOR" each separately and apart from the mark as a whole. (730) : AGRICULTURAL DEVELOPMENT CORPORATION of P. O. Box 47101 - 10100, Nairobi, Kenya (740) : None,

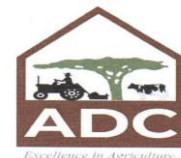

(210) : 143912 (220) : 18/12/2025 (300) : None (511) : 35(Business management, business administration, office functions, Advertising) and 37(Building, construction, repair, installation services) (526) : AFRICARegistration of this mark shall give no right to the exclusive use of the words "AFRICA", "BIO", "TANK" and the device of the "MAP OF AFRICA" each separately and apart from the mark as a whole. (730) : BIOTANK AFRICA of P. O. Box 6330 -01000, Thika, Kenya (740) : Lawrence Agoi Onginya of P. O. Box 3221 - 00100, Nairobi, Kenya



(210) : 143915 (220) : 18/12/2025 (300) : None (511) : 11(Installation and maintenance of solar power energy) (526) : JUARegistration of this mark shall give no right to the exclusive use of the words "JUA", "POWER", "BOOSTING" and "AFRICA" each separately and apart from the mark as a whole. The English translation of the Swahili word "JUA" is "The Sun". (730) : VOLTIFIX INTERNATIONAL NEW ENERGY LTD of P. O. Box 1911 - 00606, Tatu City Industrial Park, Nairobi, Kenya (740) : None,



(210) : 143935 (220) : 19/12/2025 (300) : None (511) : 36(Insurance underwriting,actuarial services;) (526) : eachRegistration of this mark shall give the right to the exclusive use of the words "DEFINITE", "ASSURANCE" and the device of a "TICK" each separately and apart from the mark as whole. The mark is proceeding in series. (730) : DEFINITE ASSURANCE COMPANY LIMITED of P. O. Box 30823 - 00100, Nairobi, Kenya (740) : None,



(210) : 143936 (220) : 19/12/2025 (300) : None (511) : 36(Insurance underwriting, actuarial services;) (526) : The registration of this mark shall give the right to the exclusive use of the letter "D" and the device of a "TICK" each separately and apart from the mark as whole. (730) : DEFINITE ASSURANCE COMPANY LIMITED of P. O. Box 30823 - 00100, Nairobi, Kenya (740) : None,



(210) : 143937 (220) : 19/12/2025 (300) : None (511) : 36(Insurance underwriting, acturial services.) (526) : DEFINITERegistration of this mark shall give right to the exclusive use of the words "DEFINITE", "ASSURANCE", "COVERED" and the "TICK DEVICE" each separately and apart from the mark as a whole. (730) : DEFINITE ASSURANCE COMPANY LIMITED of P. O. Box 30823 - 00100, Nairobi, Kenya (740) : None,



(210) : 143938 (220) : 19/12/2025 (300) : None (511) : 3(Detergents, Soap, Cosmetics) (526) : None 'SYKO' is a coined word with no meaning in English.(730) : SYNESTER KALAKO KISOVI of P. O. Box 18766 - 00500, Nairobi, Kenya (740) : None,



(210) : 143953 (220) : 19/12/2025 (300) : None (511) : 41(Entertainment; sporting and cultural activities; amusement services; casino, gaming and gambling services; betting services; sports betting and raffles and online sportsbook network services; Providing online games including online crash games, bust games, and card games; providing electronic publications; providing entertainment information via various technological platforms, including websites, telephony, mobile or handheld devices; organisation of quizzes, tournaments, games and competitions; online computer games; interactive entertainment services; providing online computer games; computer and video game amusement services; providing online casino and gaming facilities; providing information to game players about the ranking of their scores in games; competitions provided by means of the internet; information, advisory and consultancy services in connection with the aforesaid; all of the aforesaid in relation to gambling and gaming services.) and 42(Design and development of computer hardware and computer software; computer software rental; rental of electronic game equipment; rental of computer game programs; providing temporary use of non-downloadable computer programs; all of the aforesaid in relation to gambling and gaming services.) (526) : ORegistration of this mark shall give no right to the exclusive use of the letters "O", "Y" and the word "WIN" each separately and apart from the mark as a whole. "YO" is a coined word with no meaning in English. (730) : MICHEZOBET KENYA LIMITED of P. O. Box 31394 - 00100, Kenya (740) : None,

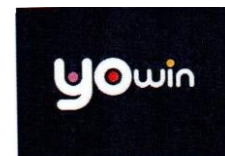

(210) : 143954 (220) : 19/12/2025 (300) : None (511) : 36(Financial, monetary and banking services; insurance services; real estate affairs.) (526) : IRegistration of this mark shall give no right to the exclusive use of the letters "I" and "M" each separately and apart from the mark as a whole The English translation of the Arabic word "BARAKAH" is "Blessings". (730) : I&M GROUP PLC of P. O. Box 30238 - 00100, 1 Park Avenue, 1st Parklands Avenue, Nairobi, Kenya (740) : None,

I&M BARAKAH

(210) : 143955 (220) : 19/12/2025 (300) : None (511) : 40(Treatment of materials; recycling of waste and trash; air purification and treatment of water; printing services; food and drink preservation) and 41(Education; providing of training; entertainment; sporting and cultural activities.) (526) : Registration of this mark shall give no right to the exclusive use of the letter "A" separately and apart from the



mark as a whole. **(730)** : SWISS FOUNDATION FOR TECHNICAL COOPERATION of P. O. Box 47996 - 00100, Nairobi, Kenya **(740)** : None,

**(210)** : 143956 **(220)** : 19/12/2025 **(300)** : None **(511)** : 36(Financial, monetary and banking services; insurance services; real estate affairs.) **(526)** : ,Registration of this mark shall give no right to the exclusive use of the words "WEALTH", "CREDIT", the letters "I" and "M" each separately and apart from the mark as a whole. **(730)** : I&M GROUP PLC of P. O. Box 30238 - 00100, 1 Park Avenue, 1st Parklands Avenue, Nairobi, Kenya **(740)** : None,

**I&M WEALTH CREDIT**

**(210)** : 143966 **(220)** : 19/12/2025 **(300)** : None **(511)** : 9(Battery chargers; Cabinets for loudspeakers; cell phone cases; cell phone covers; converters for electric plugs; data cables; electronic navigational instruments; Switches, electric; Global Positioning System[GPS] apparatus; Headphones; wearable speakers; Sound transmitting apparatus; Earphones; Portable media players; protective cases for tablet computers; protective films adapted for computer screens; stands adapted for tablet computers; transparent conductive films for displays; dashboard cameras; batteries for vehicles; Car televisions; Car stereos; wireless chargers; battery chargers for cellular phones; cell phone holders; Hands-free holders for cellular phones; in-car telephone handset cradles; Plastic screen protectors adapted for portable electronic devices other than gaming apparatus; tempered glass screen protectors adapted for portable electronic devices other than gaming apparatus; holders adapted for smartphones; gimbals for smartphones; Fire extinguishers; wearable activity trackers; cameras; Bags for photographic apparatus; selfie sticks for mobile phones; gimbals for digital cameras; Protective cases for personal digital assistants [PDAs]; mounting brackets adapted for computers; ring holders for cell phones; waterproof cases for smartphones; protective films adapted for smartphones; lanyards for mobile telephones; mobile power supply [rechargeable batteries]; Loudspeakers; electric sockets; power strips.) **(526)** : None **(730)** : SHENZHEN TORRAS TECHNOLOGY CO., LTD Incorporated in The People's Republic of China of RM C1215, BLK C, Zhantao Technology BLDG, Intersection Of Gongye East Road And Minzhi Road, Xinniu Community, Minzhi ST, Longhua DIST, Shenzhen, China **(740)** : CFL Advocates of P. O. Box 23555 -00100, Nairobi, Kenya



**(210)** : 143985 **(220)** : 22/12/2025 **(300)** : None **(511)** : 6(British Reinforcement Concrete (Brc Steel for the reinforcement of concrete), Round Steel Bars, Nails, Wire Mesh, Metal Chain-Link Fences, Barbed Wire) **(526)** : None **(730)** : BHUDEV CIVIL SUPPLIERS LIMITED of P. O. Box 11662 - 00100, Kenya **(740)** : None,

**ANCHOR**

**(210)** : 143997 **(220)** : 22/12/2025 **(300)** : None **(511)** : 39(Travel reservation; transport reservation; arranging for travel visas and travel documents for persons travelling abroad; arranging of passenger transportation services for others via an online application; providing transportation information; transport services for sightseeing tours; aircraft rental; arranging of transportation for travel tours; transport ; packaging and storage of goods; travel arrangement; air transport; passenger transport; transport; chauffeur services; booking of seats for travel; car rental; vehicle rental; rental of vehicle roof rack; bus transport; transport of travellers; taxi transport; ambulance transport ; arranging of cruises: barge transport; boat rental: boat storage; boat transport; providing driving directions for travel purposes; cable car transport; car park services / parking lot services; car sharing services car transport; carpooling services; carting; courier services [messages or merchandise]; escorting of travellers; ferry-boat transport; freight;



[shipping of goods]; freight brokerage; freight forwarding; freighting; guarded transport of valuables; locating and tracking of cargo for transportation purposes; locating and tracking of people for transportation purposes; luggage storage; marine transport; motor coach rental; physical storage of electronically stored data or documents; piloting; pleasure boat transport; providing information relating to storage services; providing traffic information; railway coach rental; railway transport; railway truck rental; refloating of ships; rental of aircraft engines ; transportation logistics.) (526) : MAGICALRegistration of this mark shall give no right to the exclusive use of the words "MAGICAL", "SKIES", "WORLD" and the symbol/device of a "STAR" each separately and apart from the mark as a whole. (730) : MAGICAL SKIES LIMITED of P. O. Box 72493, City Square, Nairobi, Kenya (740) : Kisilu, Wandati & Company Advocates of P. O. Box 29294 - 00100, Nairobi, Kenya

(210) : 144036 (220) : 23/12/2025 (300) : None (511) : 18(Imitation leather; school bags; briefcases; travelling bags; backpacks; trunks [luggage]; pocket wallets; umbrellas; walking sticks; clothing for pets.) (526) : None When read together, the mark has no known meaning. (730) : Guangzhou Jinsige Investment Co., Ltd of Room 501, Building B, No. 87, Zhenxing North Road, Zhenxing Village, Shiling Town, Huadu District, Guangzhou City, China (740) : Gitahi Munyi & Associates Advocates of P. O. Box 19785 - 00100, Nairobi, Kenya



(210) : 144043 (220) : 29/12/2025 (300) : None (511) : 32(Non-alcoholic beverages; mineral and aerated waters; fruit beverages and fruit juices; syrups and other preparations for making non-alcoholic beverages ) (526) : Registration of this mark shall give no right to the exclusive use of the word "SIMBA" separately and apart from the mark as a whole. (730) : BIDCO AFRICA LIMITED of P. O. Box 239 - 01000, General Kago Road, Thika, Kenya (740) : None,



(210) : 144055 (220) : 31/12/2025 (300) : None (511) : 31(Animal feeds) (526) : Registration of this mark shall give no right to the exclusive use of the words "STOCK", "FARM EXTRA", "MULTI PUROSE", "DAIRY & STOCK LICK", "NYAMA", "NDAMA", "DRY COWS", "SHEEP", "GOAT" and "NJAU", "IMPROVED FORMULA & SUPPLIMENTS", "BEEF", "ECONOMY NA MAZAO", the devices of a "COW", "HEIFA", "SHEEP", "BULL" and "GOAT" per se each separately and apart from the mark as a whole. The English translation of the Swahili words "NYAMA", "NDAMA" and "MAZAO" is "MEAT", "CALF" and "PRODUCTIVITY" respectively. The English translation of the Kikuyu word "NJAU" is "CALF". (730) : ANTONY KARANJA of P. O. Box 54276 - 00100, Nairobi, Kenya (740) : None,

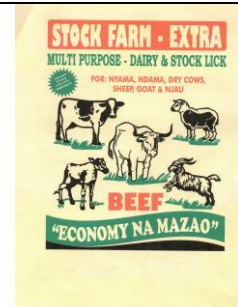

(210) : 144056 (220) : 31/12/2025 (300) : None (511) : 31(Animal feeds) (526) : Registration of this mark shall give no right to the exclusive use of the words "MAZIWA", "PLUS", "HIGH PHOSPHOROUS", "YIELDING DAIRY COWS", "IMPROVED FORMULA EXTRA SUPPLEMENT", "MILK", "IRIA", "ECONOMY NA MAZAO" and the devices of "DAIRY COWS", "A CALF", "CROSS SIGN" per se each separately and apart from the mark as a whole. The English translation of the Swahili words "MAZIWA" and "MAZAO" is "Milk" and "Productivity". The English translation of the Kikuyu word "IRIA" is "Milk". (730) : ANTONY KARANJA of P. O. Box 54276 - 00100, Nairobi, Kenya (740) : None,

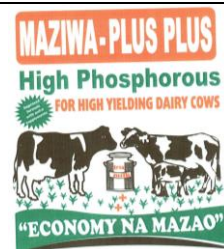

(210) : 144057 (220) : 31/12/2025 (300) : None (511) : 31(Animal feeds) (526) : ECONOMYNARegistration of this mark shall give no right to the exclusive use of the words "ECONOMY NA MAZAO" each separately and apart from the mark as a whole The English translation of the Swahili word "MAZAO" is "Productivity". (730) : ANTHONY KARANJA of P. O. Box 54276 - 00200, Nairobi, Kenya (740) : None,



(210) : 144061 (220) : 05/01/2026 (300) : None (511) : 6(Metal hardware.), 7(Machines and machine tools, motors and engines.), 9(Apparatus and instruments for conducting, switching, transforming, accumulating, regulating or controlling the distribution or use of electricity; apparatus and instruments for recording, transmitting, reproducing or processing sound.), 11(Apparatus and installations for lighting, heating, cooling, steam generating, cooking, drying, ventilating, water suppl and sanitary purposes.), 12(Parts and accessories of motorcycles, structural arts for motorcycles.), 16(Japanese handicraft.), 35(Import and export services), 40(Custom manufacturing of joinery handicraft) and 42(Scientific and technological services and research and design relating thereto; industrial analysis, industrial research and industrial design services; quality control and authentication services; design and development of computer hardware and software.) (526) : None (730) : JINNA ELECTRICAL GROUP CO. LTD of P. O. Box 50200 - 00200, Nairobi, Kenya (740) : None,



(210) : 144065 (220) : 05/01/2026 (300) : None (511) : 9(Balances [steelyards]; diagnostic apparatus, not for medical purposes; microscopes; photometers; gauges; testing apparatus not for medical purposes; gas testing instruments; laboratory centrifuges; electrolysis apparatus for laboratory use; bioreactors for laboratory use.) (526) : None The mark has no meaning in this application. (730) : YONFORCE CO., LTD Incorporated in China of Room 2, Building 5, Jinan Biomedical Zone, No. 30766 Jingshi East Road, Jinan, Shandong, China 250102, China (740) : CFL Advocates of P. O. Box 23555 - 00100, Nairobi, Kenya



(210) : 144071 (220) : 06/01/2026 (300) : None (511) : 44(Medical services) (526) : FAMILYRegistration of this mark shall give no right to the exclusive use of the words "FAMILY", "AFYA" and "HOSPITAL" each separately and apart from the mark as a whole. The English translation of the Swahili word "AFYA" is "Healthy". (730) : FAMILY AFYA VARIAN HOSPITAL LIMITED of Ruaka Shopping Mall, Kenya (740) : None,



(210) : 144083 (220) : 06/01/2026 (300) : None (511) : 5(Pharmaceutical and veterinary preparations; sanitary preparations for medical purposes; dietetic substances adapted for medical use, food for babies; plasters, materials for dressings; material for stopping teeth, dental wax; disinfectants; preparations for destroying vermin; fungicides, herbicides.) and 30(Coffee, tea, cocoa, sugar, rice, tapioca, sago, artificial coffee; flour and preparations made from cereals, bread, pastry and confectionery, ices; honey, treacle; yeast, baking-powder; salt, mustard; vinegar, sauces (condiments); spices; ice) (526) : NATURALRegistration of this mark shall give no right to the exclusive use of the words "NATURAL", "HEALTH" and "CARE" each separately and apart from the mark as a whole. "HEALIFE" means to "Restore Health" or "To Make Sound And Value". (730) : FOGO IMPORT & EXPORT LIMITED of P. O. Box 34863 - 00100, Nairobi, Kenya (740) : None,



(210) : 144084 (220) : 06/01/2026 (300) : None (511) : 21(Household or kitchen utensils and containers (not of precious metal or coated therewith); combs and sponges; brushes (except paint brushes); brush-making materials; articles for cleaning purposes; steelwool; unworked or semi-worked glass (except glass used in building); glassware, porcelain and earthenware not included in other classes ), 25(Clothing, footwear, headgear) and 27(Carpets, rugs, mats and matting, linoleum and other materials for covering existing floors; wall hangings (non-textile) (526) : andRegistration of this mark shall give no right to the exclusive use of the words "HOME" and "MART" each separately and apart from the mark as a whole. (730) : LOVE HOME MART LIMITED of P. O. Box 51303 - 00200, Nairobi, Kenya (740) : None,



**(210)** : 144087 **(220)** : 07/01/2026 **(300)** : None **(511)** : 8(Hand tools and implements, hand-operated tools and implements; cutlery; side arms, except firearms; razors.), 9(Scientific, research, navigation, surveying, photographic, cinematographic, audiovisual, optical, weighing, measuring, signalling, detecting, testing, inspecting, life-saving and teaching apparatus and instruments; apparatus and instruments for conducting, switching, transforming, accumulating, regulating or controlling the distribution or use of electricity; apparatus and instruments for recording, transmitting, reproducing or processing sound, images or data; recorded and downloadable media, computer software, blank digital or analogue recording and storage media; mechanisms for coin-operated apparatus; cash registers, calculating devices; computers and computer peripheral devices; diving suits, divers' masks, ear plugs for divers, nose clips for divers and swimmers, gloves for divers, breathing apparatus for underwater swimming; fire-extinguishing apparatus.), 11(Apparatus and installations for lighting, heating, cooling, steam generating, cooking, drying, ventilating, water supply and sanitary purposes.), 15(Musical instruments; music stands and stands for musical instruments; conductors' batons.), 20(Furniture, mirrors; picture frames; containers, not of metal, for storage or transport; unworked or semi-worked bone, horn, whalebone or mother-of-pearl; shells; meerschaum; yellow amber.) and 21(Household or kitchen utensils and containers; cookware and tableware, except forks, knives and spoons; combs and sponges; brushes, except paintbrushes; brush-making materials; articles for cleaning purposes; unworked or semi-worked glass, except building glass; glassware, porcelain and earthenware.) **(526)** : ARegistration of this mark shall give no right to the exclusive use of the letters "A", "P", "T", "Z" and the device of a "WRENCH" each separately and apart from the mark as a whole. **(730)** : ZHANG ZHIJUN of Room 1410, Block A, Central Times Square, Linyi City, Shandong Province, China **(740)** : Simon Wachira & CO. Advocates of P. O. Box 24943 - 00100, Nairobi, Kenya



**(210)** : 144146 **(220)** : 09/01/2026 **(300)** : None **(511)** : 35(Importation services for motor vehicles) **(526)** : CARRegistration of this mark shall give no right to the exclusive use of the words "CAR", "IMPORTS", the numerals "2", "4", "5" and the device of a "CAR" each separately and apart from the mark as a whole. **(730)** : PRIVCAR IMPORTS 254 SERVICES LTD of P. O. Box 68039 - 00200, Nairobi, Kenya **(740)** : None,



**(210)** : 144148 **(220)** : 09/01/2026 **(300)** : None **(511)** : 6(Alloys of common metal; pipework of metal; windows of metal; gates of metal; tiles of metal for building; wire gauze; fittings of metal for windows; locks of metal, other than electric: hinges of metal; signs, non-luminous and non-mechanical. of metal) **(526)** : None The mark has no meaning in this application. **(730)** : HENNISSY INDUSTRIAL CO., LTD Incorporated in China of No.1 Fenggang Industrial Zone, Fenggang Village Gunyao, Shishan Town, Nanhai District, Foshan City, China **(740)** : CFL Advocates of P. O. Box 23555 - 00100, Nairobi, Kenya



**(210)** : 144152 **(220)** : 09/01/2026 **(300)** : None **(511)** : 35(Advertising; business management, organization and administration; office functions - the bringing together, for the benefit of others, of a variety of goods, excluding the transport thereof, enabling customers to conveniently view and purchase those goods; such services may be provided by retail stores, wholesale outlets, through vending machines, mail order catalogues or by means of electronic media through websites or television shopping programs.) **(526)** : Registration of this mark shall give no right to the exclusive use of the word "MART" separately and apart from the mark as a whole. **(730)** : HAINA IMPORT& EXPORT TRADING CO. LTD of P. O. Box 36463 - 00200, Nairobi, Kenya



---

**(740)** : NKO Advocates LLP of P. O. Box 36463 - 00200, Nairobi, Kenya

---



**(210)** : 144154 **(220)** : 12/01/2026 **(300)** : None **(511)** : 35(Advertising; business management; business administration; office functions) and 36(Insurance; financial affairs; monetary affairs; real estate affairs) **(526)** : JRegistration of this mark shall give no right to the exclusive use of the letter "J" separately and apart from the mark as a whole. **(730)** : JUBILEE HOLDINGS LIMITED COMPANY of P. O. Box 30376 - 00100, Jubilee Insurance HQ, Kilimanjaro Avenue Upperhill, Nairobi, Kenya **(740)** : Kiptinness & Odhiambo Associates LLP of P. O. Box 42713 - 00100, Nairobi, Kenya

---



**(210)** : 144161 **(220)** : 12/01/2026 **(300)** : None **(511)** : 16(Paper, cardboard and certain goods made of those materials, as well as stationery and office requisites) **(526)** : PRINTRegistration of this mark shall give no right to the exclusive use of the word "PRINT" and the device of "BOX FILE" each separately and apart from the mark as a whole. **(730)** : OFFICEONE DISTRIBUTION LIMITED of P. O. Box 24296 - 00100, Nairobi, Kenya **(740)** : None,

---



**(210)** : 144169 **(220)** : 13/01/2026 **(300)** : None **(511)** : 36(Real estate) **(526)** : None "SIBIC" is an initial of "Standard Investment Bank International Centre". **(730)** : JAMES WANGUNYU of P. O. Box 13714 - 00800, Nairobi, Kenya **(740)** : None,

---



**(210)** : 144171 **(220)** : 13/01/2026 **(300)** : None **(511)** : 44(Medical services; veterinary services; hygienic and beauty care for human beings or animals; agriculture, horticulture and forestry services.) **(526)** : KRegistration of this mark shall give no right to the exclusive use of the letters "K", "L", "N", "S", "Y" and the word "STUDIO" each separately and apart from the mark as a whole. **(730)** : SKNLY STUDIO LIMITED of P. O. Box 11742 - 00100, 680 Building, 2nd Floor, Muindi Mbingu Street, Nairobi, Kenya **(740)** : None,

---



**(210)** : 144172 **(220)** : 13/01/2026 **(300)** : None **(511)** : 41(Education and training services in the fields of biophilia, sustainability, architecture, wellness, and culture-centered design; organization of conferences, workshops, seminars, retreats, and interactive learning sessions; providing of cultural, spiritual, and wellness activities; production of podcasts, documentaries, and educational media; facilitation of guided nature-based reflective and coaching sessions.) **(526)** : B",Registration of this mark shall give no right to the exclusive use of the letters "B", "G", "L" and the words "GREEN", "BIOPHILIC" and "LIVING" each separately and apart from the mark as a whole. **(730)** : VENESSA WANGUI MWANGI of P. O. Box 70307 - 00400, Kenya **(740)** : None,

---



**(210)** : 144173 **(220)** : 13/01/2026 **(300)** : None **(511)** : 10(Medical equipments, devices, apparatus) **(526)** : None "AKSHAR" is a coined word with no meaning at all. **(730)** : VICTORIA HEALTHCARE LIMITED of P. O. Box 1303 - 40100, Kisumu, Kenya **(740)** : None,





---

**(210)** : 144182 **(220)** : 13/01/2026 **(300)** : None **(511)** : 4(LP gas) **(526)** : GASRegistration of this mark shall give no right to the exclusive use of the word "GAS", the devices of the "FLAME" and "CYLINDER" each separately and apart from the mark as a whole. **(730)** : FAST LITE ENTERPRISE LIMITED of P. O. Box 571 - 00622, Juja, Kenya **(740)** : None,

---



<p>(210) : 144184 (220) : 13/01/2026 (300) : None (511) : 9(Scientific, nautical, surveying, photographic, cinematographic, optical, weighing, measuring, signaling, checking (supervision), life-saving and teaching apparatus and instruments; apparatus and instruments for conducting, switching, transforming, accumulating, regulating or controlling electricity; apparatus for recording, transmission or reproduction of sound or images; magnetic data carriers, recording discs; compact discs, DVDs and other digital recording media; mechanisms for coin-operated apparatus; cash registers, calculating machines, data processing equipment, computers; computer software; fire - extinguishing apparatus) and 36(Insurance; financial affairs; monetary affairs; real estate affairs) (526) : AIRTIMERegistration of this mark shall give no right to the exclusive use of the words "AIRTIME" and "SOKO" each separately and apart from the mark as a whole. "SOKO" is a Swahili word meaning. "MARKETPLACE" in English. (730) : NICHOLAS KIPNGETICH KORIR of P. O. Box 479 - 20200, Kericho, Kenya (740) : None,</p>	
<p>(210) : 144191 (220) : 13/01/2026 (300) : None (511) : 9(Headphones, speakers, power banks, charging cables, smart glasses, microphones, smart watches, smart rings, USB flash drives, memory card and charging adaptors.) (526) : None (730) : SHENZEN HUAWANDA ELECTRONICS CO. LTD of P. O. Box 7769 - 00200, Nairobi, Kenya (740) : None,</p>	
<p>(210) : 144195 (220) : 13/01/2026 (300) : None (511) : 16(Paperboard boxes for industrial packaging) (526) : Registration of this mark shall give no right to the exclusive use of the letters 'R' and 'P' each separately and apart from the mark as a whole. (730) : RACK AND PACKS LTD of P. O. Box 3410 - 00100, Nairobi, Kenya (740) : None,</p>	
<p>(210) : 144196 (220) : 13/01/2026 (300) : None (511) : 16(Paperboard boxes for industrial packaging) (526) : Registration of this mark shall give no right to the exclusive use of the word "RACK" separately and apart from the mark as a whole. (730) : RACK AND PACKS LTD of P. O. Box 3410 - 00100, Nairobi, Kenya (740) : None,</p>	
<p>(210) : 144197 (220) : 13/01/2026 (300) : None (511) : 16(Paperboard boxes for industrial packaging) (526) : Registration of this mark shall give no right to the exclusive use of the word "RACK" separately and apart from the mark as a whole (730) : RACK AND PACKS LTD of P. O. Box 3410 - 00100, Nairobi, Kenya (740) : None,</p>	
<p>(210) : 144198 (220) : 13/01/2026 (300) : None (511) : 35(Branding and Advertisement services) (526) : Registration of this mark shall give no right to the exclusive use of the letter 'K' separately and apart from the mark as a whole. (730) : KKRAFT BRAND DESIGN LIMITED of P. O. Box 3410 - 00100, Nairobi, Kenya (740) : None,</p>	
<p>(210) : 144200 (220) : 13/01/2026 (300) : None (511) : 35(Branding and advertisement services) (526) : None (730) : KKRAFT BRAND DESIGN LIMITED of P. O. Box 3410 - 00100, Nairobi, Kenya (740) : None,</p>	
<p>(210) : 144201 (220) : 13/01/2026 (300) : None (511) : 35(Branding and advertisement services) (526) : None (730) : KKRAFT BRAND DESIGN LIMITED of P. O. Box 3410 - 00100, Nairobi, Kenya (740) : None,</p>	
<p>(210) : 144202 (220) : 13/01/2026 (300) : None (511) : 35(Branding and advertisement services) (526) : Registration of this mark shall give no right to the exclusive use of the letter 'K' separately and apart from the mark as a whole (730) : KKRAFT BRAND DESIGN LIMITED of P. O. BOX 3410 -00100, Nairobi, Kenya (740) : None,</p>	
<p>(210) : 144206 (220) : 14/01/2026 (300) : None (511) : 25(Footwear; shoes; boots; sandals; slippers; clothing; headwear) (526) : None "NADA" is a coined word with no meaning. (730) : ZAHRA HOLDINGS CO. LIMITED of P. O. Box 46077 - 00100 Parklands, Kenya (740) : None,</p>	

(210) : 144218 (220) : 14/01/2026 (300) : None (511) : 9(Mobile Phone) (526) : None (730) : AXXON INDUSTRIES LIMITED of P. O. Box 104021 -00101, Nairobi, Kenya (740) : None,	
(210) : 144229 (220) : 15/01/2026 (300) : None (511) : 5(Pharmaceuticals) (526) : Registration of this mark shall give no right to the exclusive use of the letters "I", "S" and "O" each separately and apart from the mark as a whole. (730) : AUSHNLIFE KENYA LIMITED of P. O. Box 00164 - 00100, Nairobi, Kenya (740) : None,	ISO-CALDENZ
(210) : 144230 (220) : 15/01/2026 (300) : None (511) : 5(Pharmaceuticals) (526) : Registration of this mark shall give no right to the exclusive use of the letters "X", "T" and "Z" each separately and apart from the mark as a whole. (730) : AUSHNLIFE KENYA LIMITED of P. O. Box 00164 - 00100, Nairobi, Kenya (740) : None,	KYARE - XTZ
(210) : 144231 (220) : 15/01/2026 (300) : None (511) : 5(Pharmaceuticals) (526) : Registration of this mark shall give no right to the exclusive use of the plus sign "+" separately and apart from the mark as a whole. (730) : AUSHNLIFE KENYA LIMITED of P. O. Box 00164 - 00100, Nairobi, Kenya (740) : None,	CALDENZ+
(210) : 144232 (220) : 15/01/2026 (300) : None (511) : 5(Pharmaceuticals) (526) : Registration of this mark shall give no right to the exclusive use of the numeral "5" separately and apart from the mark as a whole. (730) : AUSHNLIFE KENYA LIMITED of P. O. Box 00164 - 00100, Nairobi, Kenya (740) : None,	MECODENZ-5
(210) : 144233 (220) : 15/01/2026 (300) : None (511) : 5(Pharmaceuticals) (526) : 1Registration of this mark shall give no right to the exclusive use of the letter "Q", the numerals "0" and "1", each separately and apart from the mark as a whole. (730) : AUSHNLIFE KENYA LIMITED of P. O. Box 00164 - 00100, Nairobi, Kenya (740) : None,	Q-DENZ-100
(210) : 144262 (220) : 15/01/2026 (300) : None (511) : 16(Paper, stationery, printed materials), 30(Food Products (Staples & Processed Foods) and 35(Advertising, retail, business & marketing services) (526) : Registration of this mark shall give no right to the exclusive use of the word "BAKERY" separately and apart from the mark as a whole. (730) : CHERIE BAKERY of P. O. Box 45880 - 00100, Kenya (740) : None,	CHERIE BAKERY
(210) : 144283 (220) : 16/01/2026 (300) : None (511) : 9(Safety and security apparatus and instruments) and 42(Design and development of computer hardware and software) (526) : Registration of this mark shall give no right to the exclusive use of the word "SECURING" and the device of "FINGERPRINT LOCK" each separately and apart from the mark as a whole. (730) : PRONTO PROCESSES LIMITED of P. O. Box 19895 - 00100, K20, Gatundu Road, Kileleshwa, Nairobi, Kenya (740) : None,	
(210) : 144287 (220) : 16/01/2026 (300) : None (511) : 30(Rice) (526) : Registration of this mark shall give no right to the exclusive use of the words "RICE", "PREMIUM", "QUALITY", "GRADE", the numeral "1", the devices of "SERVING BOWL WITH RICE" and "ASSORTED FOOD" each separately and apart from the mark as a whole. The English translation of the Arabic word "NAJAH" forming part of the mark is "Achievement". (730) : ATRAAB GROUP LIMITED a Private Limited Company duly incorporated under the laws of Kenya of P. O. Box 00600 - 00100, Nairobi, Kenya (740) : None,	
(210) : 144300 (220) : 19/01/2026 (300) : None (511) : 12(Motor bikes and spare parts) (526) : Registration of this mark shall give no right to the exclusive use of the words "ECO" and "RIDE" each separately and apart from the mark as a whole. (730) : CHRISTINE NYAMBURA MAINA of P. O. Box 61631, Kenya (740) : None,	

---

**STANBIZZ**

(210) : 144301 (220) : 19/01/2026 (300) : None (511) : 9(Scientific, nautical, surveying, photographic, cinematographic, optical, weighing, measuring, signaling, checking (supervision), life-saving and teaching apparatus and instruments; electric and electronic apparatus and hardware, equipment for the storage and transmission of data and information for use in relation to banking, financial, insurance and general commercial transactions, including those conducted online via the Internet or a computer network, or by telephone or cellular telephone; software, systems, devices and platforms used to enable and facilitate electronic banking, financial, insurance or other commercial transactions, including those via the Internet or a computer network, or by telephone or cellular telephone; including data processing equipment and software for use in relation to banking and financial services including data processing equipment and software; downloadable electronic publications; apparatus and equipment for the electronic transfer of and/or financial data; telecommunication equipment; automated teller machines; money dispensing machines, electronic fund transfer, payment or point of sale apparatus, machines and terminals; card and bar code scanners ; magnetic and magnetically encoded cards; programmable cards; smart cards; cards bearing coded data in magnetic form; cards bearing data for use in computers; cards bearing coded data in punched-out form; cards bearing data for use in data processing apparatus; cards bearing data for use in data storage apparatus; cards bearing electronically recorded data; cards bearing integrated circuits; cards bearing magnetic or encoded data for input; cards bearing micro-chips and computer cards containing chips; credit , charge, debit and/or cash cards; prepayment cards [encoded]; loyalty or gift cards [encoded], readers, scanners, parts and fittings for the aforementioned goods.), 16(Paper, cardboard and goods made from these materials, not included in other classes; printed matter; books, magazines, manuals , newspapers, newsletters, pamphlets; bookbinding material; photographs; stationery; adhesives for stationery or household purposes; artists' materials; paint brushes; typewriters, office requisites (except furniture); instructional and teaching materials (except apparatus); wrapping and packaging materials; plastic materials for packaging (not included in other classes); printers' type; printing blocks; printed publications; newsletters, reviews and publications; documentation relating to financial, banking, insurance and investment services or transactions; advertising materials; brochures, vouchers, cheques, cheque books; cheque book holders; paying-in books; bank cards, cash cards, cheque cards, debit cards, credit cards, charge cards, loyalty or gift cards all being other than encoded or magnetic cards), 35(Advertising; business management; business administration; office functions; facilitation of commercial and business transactions, including those conducted online via the Internet or a computer network, or by telephone or cellular telephone; business strategy services; business appraisal and analysis services; database management services; provision of business and commercial advice and information provided by telephone or provided online from a computer database, computer network, global computer network or the Internet; business planning; business strategy services, business appraisals; business management assistance; business support; accounting; economic forecasting and analysis for business purposes; profit and cash flow forecasting, analysis and planning, all being economic forecasting services; personnel management and employment consultancy; database management services, data processing, data verification and file management; computerised business information storage and retrieval; credit card registration services; procurement of goods and services on behalf of businesses;

---

purchasing of goods and services for other businesses; business administration services for the processing of sales and transactions made on a global computer network or the Internet; the bringing together, for the benefit of others, of a variety of goods including but not limited to, business equipment, enabling customers to conveniently view and purchase those goods from a computer network website or an Internet website; offering for sale and the sale of goods in the retail and wholesale trade; customer loyalty reward schemes, customer care services; advisory, consultancy, information and helpline services relating to all of the aforesaid services ancillary or related to the aforementioned all in class 35.), 36(Insurance products and services; financial affairs; monetary affairs; real estate affairs; banking services; payment facilitation services, facilitation and rendering of banking and financial transactions, including those rendered online via the Internet or computer network, or by telephone or cellular telephone; services ancillary and related to all of the foregoing, all in class 36.), 38(Telecommunications and communications services; providing user access to computer networks or the Internet for purposes of facilitating commercial, banking or financial transactions and electronic payments; providing telecommunications connections to the Internet or data bases for purposes of facilitating commercial, banking or financial transactions and electronic payments services ancillary and related to all of the foregoing, all in class 38), 41(Education; providing of training; entertainment; sporting and cultural activities; television entertainment; organising and conducting of competitions; publication of printed matter, services ancillary and related to all of the foregoing, all in class 41) and 42(Scientific and technological services and research and design relating thereto; industrial analysis and research services; IT services, design and development of computer hardware and software and computer systems; operation of websites and online transactional platforms; rental of computer hardware and software; leasing of access time to computer database; advisory, information, evaluations, consultancy services; services ancillary and related to all of the foregoing, all in class 42.) (526) : None (730) : THE STANDARD BANK OF SOUTH AFRICA LIMITED Incorporated in South Africa of 5 Simmonds Street, Johannesburg 2001, Gauteng, South Africa (740) : Coulson Harney LLP of P. O. Box 10643 - 00100, Nairobi, Kenya

(210) : 144312 (220) : 20/01/2026 (300) : None (511) : 30(Honey, honeycomb, honey derivative propolis and bees wax) and 35(Wholesale and retail services of honey, honeycomb, honey propolis and beeswax) (526) : HONEYRegistration of this mark shall give no right to the exclusive use of the words "APIARY", "BEES", "HONEY", "NATURE", "PREMIUM", "PURE", "SUSWA" and the device of the "BEE" each separately and apart from the mark as a whole (730) : PAULINE WAIRIMU of P. O. Box 3002 - 00502, Nairobi, Kenya (740) : None,



(210) : 144319 (220) : 20/01/2026 (300) : None (511) : 36(Financial, monetary and banking services; insurance services.) (526) : None The English translation of the Swahili word "NASUA" is "Untangle". (730) : ABDULAZIZ MOHAMED OMAR of P. O. Box 10985 - 00100, Nairobi, Kenya (740) : None,

**nasua**

(210) : 144321 (220) : 21/01/2026 (300) : None (511) : 18(Leather goods & bags; handbags, tote bags, backpacks, shoulder bags, travel bags, luggage, purses, wallets, cosmetic bags, shopping bags, briefcases) and 24(Textile & household textile products; blankets, bed covers, bed sheets, quilts, duvet covers, curtains, household textile products.) (526) : None "AURELA" is a coined word that has no meaning in English. (730) : G & S SELECTIONS COMPANY LIMITED of P. O. Box 104554 - 00101, Nairobi, Kenya (740) : None,

**Aurela**

(210) : 144322 (220) : 21/01/2026 (300) : None (511) : 1(Foliar feed)  
 (526) : Registration of this mark shall give no right to the exclusive use of the words 'HIGH', 'POTASSIUM', 'FOLIAR', 'FEEDS' and the letter 'P' each separately and apart from the mark as a whole. (730) : FARM SCIENCES LIMITED of P. O. Box 112 - 00900, Kiambu, Kenya (740) : None,



(210) : 144323 (220) : 21/01/2026 (300) : None (511) : 1(Foliar feed)  
 (526) : Registration of this mark shall give no right to the exclusive use of the words 'REGULAR' each separately and apart from the mark as a whole. (730) : FARM SCIENCES LIMITED of P. O. Box 112 - 00900, Kiambu, Kenya (740) : None,



(210) : 144324 (220) : 21/01/2026 (300) : None (511) : 1(Foliar feed)  
 (526) : Registration of this mark shall give no right to the exclusive use of the words 'HIGH', 'NITROGEN', 'FOLIAR', 'FEEDS' and the letter 'N' each separately and apart from the mark as a whole. (730) : FARM SCIENCES LIMITED of P. O. Box 112 - 00900, Kiambu, Kenya (740) : None,



(210) : 144325 (220) : 21/01/2026 (300) : None (511) : 1(Foliar feed)  
 (526) : Registration of this mark shall give no right to the exclusive use of the words 'HIGH', 'PHOSPHORUS', 'FOLIAR', 'FEEDS' and the letter 'P' each separately and apart from the mark as a whole. (730) : FARM SCIENCES LIMITED of P. O. Box 112 - 00900, Kiambu, Kenya (740) : None,



(210) : 144330 (220) : 21/01/2026 (300) : None (511) : 12(Motorcycles; electric motorcycles; electric scooters; electric mopeds; electric bicycles; parts and fittings for the aforesaid goods; apparatus for locomotion by land.) and 35(Retail and wholesale services relating to motorcycles, electric motorcycles, electric scooters, electric mopeds and electric bicycles; importation and exportation services; distribution of the aforesaid goods; marketing, advertising and promotional services relating to the aforesaid goods; online retail services.) (526) : None (730) : BAYLINE IMPORT EXPORT LIMITED of P. O. Box 18878 - 00500, Nairobi, Kenya (740) : None,



(210) : 144335 (220) : 21/01/2026 (300) : None (511) : 30(Maize flour, Porridge) (526) : Registration of this mark shall give no right to the exclusive use of the words "RATEGO", "UNGA", "SAFI", "MAHINDI", "PREMIUM", "MAIZE", "MEAL" and the device of a "HUMAN FIGURE" per se each separately and apart from the mark as a whole. The English translation of the Swahili words "UNGA", "SAFI" and "MAHINDI" is "FLOUR", "CLEAN" and "MAIZE" respectively. The English translation of the Luo word "RATEGO" is "STRENGTH". (730) : RATEGO FLOUR LIMITED of P. O. Box 12 - 40601, Bondo, Kenya (740) : None,



(210) : 144342 (220) : 21/01/2026 (300) : None (511) : 31(Animal feeds) (526) : Registration of this mark shall give no right to the exclusive use of the words "FEEDS" and letters "M" and "S" each separately and apart from the mark as a whole. (730) : SURE MIXED FEEDS LIMITED of P. O. Box 48608 - 00200, Nairobi, Kenya (740) : None,



(210) : 144356 (220) : 22/01/2026 (300) : None (511) : 38(Telecommunications) (526) : Registration of this mark shall give no right to the exclusive use of the acronym "FM" separately and apart from the mark as a whole. "NIA" stands for intention or purpose, it refer to purpose or motive behind doing something. (730) : DANIEL RUSSO of P. O. Box 87 - 00100, The Mvuli lane, Nairobi, Kenya (740) : None,



**(210)** : 144366 **(220)** : 22/01/2026 **(300)** : None **(511)** : 1(Chemicals used in industry, science and photography, as well as in agriculture, horticulture and forestry; unprocessed artificial resins, unprocessed plastics; manures; fire extinguishing compositions; tempering and soldering preparations; chemical substances for preserving foodstuffs; tannin substances; adhesives used in industry), 2(Paints, varnishes, lacquers; preservatives against rust and against deterioration of wood; colorants; mordants; raw natural resins; metals in foil and powder form for painters, decorators, printers and artists), 17(Rubber, gutta-percha, gum, asbestos, mica and goods made from these materials and not included in other classes; plastics in extruded form for use in manufacture; packing, stopping and insulating materials; flexible pipes, not of metal), 19(Building materials (non-metallic); non-metallic rigid pipes for building; asphalt, pitch and bitumen; non-metallic transportable buildings; monuments, not of metal) and 35(Advertising ; business management; business administration; office functions) **(526)** : None **(730)** : GRESOLS JENGA SOLUTIONS LIMITED Limited liability company of P. O. Box 45657 - 00100, 4th Parklands Road, Diamond Plaza 2, Westlands, Nairobi, Kenya **(740)** : None,



**(210)** : 144373 **(220)** : 22/01/2026 **(300)** : None **(511)** : 30(Flour) **(526)** : "GRADE", Registration of this mark shall give no right to the exclusive use of the words "GRADE", "SIFTED", "MAIZE", "MEAL" and the numeral "1" each separately and apart from the mark as a whole. The English translation of the Swahili word "MIALE" is "Sunrays". **(730)** : SAMSON EGWINA of P. O. Box 583 - 00219, Migori, Kenya **(740)** : None,



**(210)** : 144381 **(220)** : 23/01/2026 **(300)** : None **(511)** : 36(Financial, monetary and banking services:) **(526)** : Registration of this mark shall give no right to the exclusive use of the word "WEKEZA" separately and apart from the mark as a whole. The English translation of the Kiswahili word "WEKEZA" is to "Save" or "Invest". **(730)** : WEKEZA BROADBAND LIMITED of P. O. Box 40639 - 00100, Nairobi, Kenya **(740)** : None,



**(210)** : 144401 **(220)** : 23/01/2026 **(300)** : None **(511)** : 44(Dermatologist consultation, acne treatment, fungal infections and scar revision/keloid removal) **(526)** : Registration of this mark shall give no right to the exclusive use of the words "AFYA", "DERM", "SKIN", "CLINIC", the letters "A", "S" and the device of a "human figure" per se each separately and apart from the mark as a whole. The English translation of the Kiswahili word "AFYA" is "Health". **(730)** : DR. JACQUELINE MUTUA of P. O. Box 12218 - 00040, Waka Towers, Ground Floor, , Kenya **(740)** : None,



**(210)** : 144403 **(220)** : 23/01/2026 **(300)** : None **(511)** : 28(playing card game for lawyers) **(526)** : Registration of this mark shall give no right to the exclusive use of the words "KENYAN", "LAWYER", "CARD", "GAME", the devices of "CARD" and "SCALES OF JUSTICE" each separately and apart from the mark as a whole. **(730)** : LEAH WANJA MATI of P. O. Box 30701 - 00100, Nairobi, Kenya **(740)** : None,

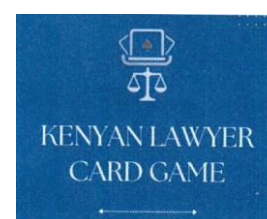

**(210)** : 144405 **(220)** : 26/01/2026 **(300)** : None **(511)** : 12(Vehicle; apparatus for locomotion by land, air or water) **(526)** : BIKERegistration of this mark shall give no right to the exclusive use of the word "BIKE" separately and apart from the mark as a whole. **(730)** : HOUSE OF GIKOMBA LTD of P. O. Box 39053 - 00623, Nairobi, Kenya **(740)** : None,



(210) : 144416 (220) : 26/01/2026 (300) : None (511) : 43(Services for providing food and drink; temporary accomodation) (526) : None The translation into English of the Maasai vernacular words 'TEMBO ENKAI' is 'Elephant' and 'God' respectively. (730) : TEMBO ENKAI LIMITED of P. O. Box 49796 - 00100 Nairobi, Kenya (740) : None,



(210) : 144420 (220) : 26/01/2026 (300) : None (511) : 39(Hire and rental of speed boats.) (526) : OCEANRegistration of this mark shall give no right to the exclusive use of the words "OCEAN" and "SAFARIS" each separately and apart from the mark as a whole. The English translation of the Swahili word "SAFARIS" is "JOURNEYS". (730) : OCEAN CRUISE EAST AFRICAN NAUTICAL SAFARI LIMITED of P. O. Box 80085, GPO, Mombasa, Kenya (740) : None,



(210) : 144421 (220) : 26/01/2026 (300) : None (511) : 5(Pharmaceuticals) (526) : Registration of this mark shall give no right to the exclusive use of the letters 'O' and "Z" each separately and apart from the mark as a whole. (730) : TRIMURTI HEALTHCARE LTD of P. O. Box 38828 - 00623, Nairobi, Kenya (740) : None,



(210) : 144423 (220) : 26/01/2026 (300) : None (511) : 5(Dietary supplements for human beings) (526) : None (730) : TRIMURTI HEALTHCARE LTD of P. O. Box 38828 - 00623, Nairobi, Kenya (740) : None,



(210) : 144451 (220) : 27/01/2026 (300) : None (511) : 5(Pharmaceutical and medical preparations; sanitary preparations for medical purposes; dietetic food and substances adapted for medical or veterinary use, food for babies; dietary supplements for humans and animals; plasters, materials for dressings; material for stopping teeth, dental wax; disinfectants) (526) : None (730) : TAWWAB PHARMA PVT. LIMITED of Sudarshan sky garden, d block 1201, marigold, gb road, thane 400615, India (740) : Kabau & Associates Advocates of P.O. Box 101136 - 00101, Nairobi, Kenya



(210) : 144487 (220) : 28/01/2026 (300) : None (511) : 41(Education; providing of training; entertainment; sporting and cultural activities.) (526) : PROFESSIONALRegistration of this mark shall give no right to the exclusive use of the words "PROFESSIONAL", ESPORTS" and "ASSOCIATION" each separately and apart from the mark as a whole. (730) : PROFESSIONAL ESPORTS ASSOCIATION (KENYA) of P. O. Box 1055 - 80108, Kilifi, Kenya (740) : None,



(210) : 144499 (220) : 28/01/2026 (300) : None (511) : 43(Services for providing food and drink; temporary accommodation.) (526) : RESIDENCESRegistration of this mark shall give no right to the exclusive use of the words "BEACH", "RESORT", "WATAMU" and "RESIDENCES" each separately and apart from the mark as a whole. "OCEARA" is a coined name with no specific meaning. (730) : SANDS OF DARAKASI RESORT LIMITED of P. O. Box 30569 - 00100, Nairobi, Kenya (740) : None,



(210) : 144505 (220) : 28/01/2026 (300) : None (511) : 2(Food colourings) (526) : Registration of this mark shall give no right to the exclusive use of the word "COLOURS" separately and apart from the mark as a whole. (730) : CAPEL FOOD INGREDIENTS LIMITED of P. O. Box 49916 - 00100, Nairobi, Kenya (740) : None,



(210) : 144506 (220) : 28/01/2026 (300) : None (511) : 30(Food flavourings) (526) : Registration of this mark shall give no right to the exclusive use of the word "FLAVOURS" separately and apart from the mark as a whole. (730) : CAPEL FOOD INGREDIENTS LIMITED of P. O. Box 49916 - 00100, Nairobi, Kenya (740) : None,



(210) : 144507 (220) : 28/01/2026 (300) : None (511) : 3(Bleaching preparations and other substances for laundry use; cleaning, polishing, scouring, and abrasive preparations; soaps; perfumery, essential oils, cosmetics, hair lotions; dentifrices.) and 44(Medical services; veterinary services; hygienic and beauty care for human beings or animals; agriculture, horticulture, and forestry services.) (526) : BLOOM Registration of this mark shall give no right to the exclusive use of the words "BLOOM", "CROWNED", "BEAUTY" and the device of the "CROWN" each separately and apart from the mark as a whole. "U'THAQA" is a coined word and has no meaning in English. (730) : U'THAQA BLOOM LIMITED A Limited liability company duly incorporated in Kenya of P. O. Box 22518 - 00100, Nairobi, Kenya (740) : William Karoki & Associates (WKA) Advocates of P. O. Box 10343 - 00100, Nairobi, Kenya



(210) : 144508 (220) : 28/01/2026 (300) : None (511) : 42(Scientific and technological services and research and design relating thereto; quality control and authentication services; design and development of computer software. Service of engineers and scientists who undertake evaluations, estimates, research and reports in the scientific and technological fields. Software as a service (SaaS), Platform as a service (PaaS). Architectural and urban planning services. Industrial design, design of computer software and systems.) (526) : Registration of this Mark shall give no right to the exclusive use of the words "ONLINE", "BUSINESS", "GLOBAL", "ENGINEERING", "CONSTRUCTION" and "ECOSYSTEM" each separately and apart from the mark as a whole. "MHANDISI" is a Swahili word that translates to engineer in English. (730) : MHANDISI ONLINE BUSINESS of P. O. Box 76145 - 00508, Yaya Central Kenya., Kenya (740) : None,



(210) : 144518 (220) : 29/01/2026 (300) : None (511) : 35(Import and export services) (526) : Registration of this mark shall give no right to the exclusive use of the words "SPARES", "ELEGANCE PARTS" and the device of "GEARS" per se each separately and apart from the mark as a whole. (730) : RAPHAEL MUTWIRI BAARIU of P. O. Box 80100 - 80120, Mombasa, Kenya (740) : None,



(210) : 144525 (220) : 29/01/2026 (300) : None (511) : 32(Purified drinking water) (526) : AQUA Registration of this mark shall give no right to the exclusive use of the words "AQUA", "PURIFIED", "DRINKING", "WATER" and the device of "WATER SPLASH" per se each separately and apart from the mark as a whole. (730) : NERIAAN HOLDINGS LIMITED of P. O. Box 13888 - 00500, Nairobi, Kenya (740) : None,



(210) : 144526 (220) : 29/01/2026 (300) : None (511) : 32(Purified drinking water) (526) : PURIFIED Registration of this mark shall give no right to the exclusive use of the words "AQUA", "PURIFIED DRINKING", "WATER", "DROP" and the device of "WATER SPLASH" per se each separately and apart from the mark as a whole. (730) : NERIAAN HOLDINGS LIMITED of P. O. Box 13888 - 00800, Nairobi, Kenya (740) : None,



(210) : 144541 (220) : 30/01/2026 (300) : None (511) : 3(Cleaning, polishing, scouring and abrasive preparations.) (526) : None The mark is restricted to the colours "RED", "BLUE" and "WHITE". "RENI" is a coined and arbitrary word. (730) : ZENNOR ELPRIVE INDUSTRIES LTD of P. O.



Box 30256 - 00100, Export Processing Zone, Athi River Embakasi, Nairobi, Kenya (740) : None,

(210) : 144554 (220) : 30/01/2026 (300) : None (511) : 17(Seal threads.) (526) : None (730) : CHEN KUN of P. O Box 558 - 00204 , Athi River, Kenya (740) : None,

**SINMER**

(210) : 144555 (220) : 30/01/2026 (300) : None (511) : 17(Sanitary apparatus and installations.) (526) : Registration of this mark shall give no right to the exclusive use of the word "PLASTIC" separately and apart from the mark as a whole (730) : NEW FLAMINGO HARDWARE & PAINTS LIMITED of P. O. Box 39207 - 00623, Nairobi, Kenya (740) : None,

**ORIENT PLASTIC**

(210) : 144572 (220) : 30/01/2026 (300) : None (511) : 3(Bleaching preparations and other substances for laundry use; cleaning, polishing, scouring and abrasive preparations; soaps; perfumery, essential oils, cosmetics, hair lotions; dentifrices.) and 16(Tissue papers, sealing tapes for stationary use, cling film, cling film plastic for packaging, Paper, cardboard and goods made from these materials, not included in other classes; printed matter; bookbinding material; photographs; stationery; adhesives for stationery or household purposes; artists' materials; paint brushes; typewriters and office requisites (except furniture); instructional and teaching material (except apparatus); plastic materials for packaging (not included in other classes); printers' type; printing blocks) (526) : Registration of this Mark shall give no right to the exclusive use of the letters "G" and "F" each separately and apart from the mark as a whole. The word "LINUXUAN" is a Chinese word without specific meaning in this application. (730) : LI SHUN of P. O. Box 843 -00520, Nairobi, Kenya (740) : None,



(210) : 144575 (220) : 30/01/2026 (300) : None (511) : 39(Transport Services) (526) : Registration of this mark shall give no right to the exclusive use of the letters 'C' and 'D' each separately and apart from the mark as a whole. (730) : MURIITHI ZACHARIA MURAGURI of P. O. Box 66 - 10210 Gacharage, Kenya (740) : None,

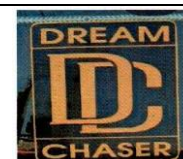

(210) : 144579 (220) : 30/01/2026 (300) : None (511) : 20(Furniture) (526) : JRegistration of this mark shall give no right to the exclusive use of the letters "J", "K" and the word "FURNITURE" each separately and apart from the mark as a whole. (730) : JAYKAY FURNITURE LTD of P. O. Box 22401 - 00500, Kenya (740) : None,



(210) : 144582 (220) : 30/01/2026 (300) : None (511) : 2(anti- graffiti coatings; anti- rust oils; badigeon; binding preparations for paints, agglutinants for paints; black Japan; ceramic paints; coatings (paints) colorants; distempers; dyes; fireproof paints; lacquers; oils for preservation of wood; paints; pigments; primers; thinners for lacquers; thinners for paints; varnishes; wood coatings (paints); wood floor finishes), 19(asbestos mortar; beacons, not of metal, non-luminous; binding material for road repair; bituminous products for building;building materials with soundproofing qualities and not of metal, construction materials with soundproofing qualities and not of metal; building materials, not of metal, construction materials not of metal; building panels, not of metal; coatings (building materials) and 37(building insulating; building sealing, damp- proofing (building); construction; construction consultancy; furniture maintenance; furniture maintenance; painting, interior and exterior) (526) : Registration of this mark shall give no right to the exclusive use of the word "KING" separately and apart from the mark as a whole. (730) : TOCONNO PAINTS LIMITED of P. O. Box 15598 - 00400, Padmore Residences, George Padmore Road, Westlands, Nairobi, Kenya (740)



: Ong'anya Ombo Advocates LLP of P. O. Box 15598 - 00400, Nairobi, Kenya

**(210)** : 144583 **(220)** : 30/01/2026 **(300)** : None **(511)** : 2(anti- graffiti coatings; anti- rust oils; badigeon; binding preparations for paints, agglutinants for paints; black Japan; ceramic paints; coatings (paints) colorants; distempers; dyes; fireproof paints; lacquers; oils for preservation of wood; paints; pigments; primers; thinners for lacquers; thinners for paints; varnishes; wood coatings (paints); wood floor finishes), 19(asbestos mortar; beacons, not of metal, non-luminous; binding material for road repair; bituminous products for building; building materials with soundproofing qualities and not of metal, construction materials with soundproofing qualities and not of metal; building materials, not of metal, construction materials not of metal; building panels, not of metal; coatings (building materials)) and 37(building insulating; building sealing, damp- proofing (building); construction; construction consultancy; furniture maintenance; furniture maintenance; painting, interior and exterior) **(526)** : Registration of this mark shall give no right to the exclusive use of the word 'PAINT' separately and apart from the mark as a whole. The English transliteration of the Chinese characters is "Specializing in Superficial Articles!". **(730)** : TOCONNO PAINTS LIMITED of P. O. Box 15598 - 00400, Padmore Residences, George Padmore Road, Westlands, Nairobi, Kenya **(740)** : Ong'anya Ombo Advocates LLP of P. O. Box 15598 - 00400, Nairobi, Kenya



**(210)** : 144586 **(220)** : 30/01/2026 **(300)** : None **(511)** : 2(anti- graffiti coatings; anti- rust oils; badigeon; binding preparations for paints, agglutinants for paints; black Japan; ceramic paints; coatings (paints) colorants; distempers; dyes; fireproof paints; lacquers; oils for preservation of wood; paints; pigments; primers; thinners for lacquers; thinners for paints; varnishes; wood coatings (paints); wood floor finishes), 19(asbestos mortar; beacons, not of metal, non-luminous; binding material for road repair; bituminous products for building; building materials with soundproofing qualities and not of metal, construction materials with soundproofing qualities and not of metal; building materials, not of metal, construction materials not of metal; building panels, not of metal; coatings (building materials)) and 37(building insulating; building sealing, damp- proofing (building); construction; construction consultancy; furniture maintenance; furniture maintenance; painting, interior and exterior) **(526)** : Registration of this mark shall give no right to the exclusive use of the Chinese characters each separately and apart from the mark as a whole The english transliteration of the Chinese characters is "Specializing in Superficial Articles". **(730)** : TOCONNO PAINTS LIMITED of P. O. Box 15598 - 00400, Padmore Residences, George Padmore Road, Westlands, Nairobi, Kenya **(740)** : Ong'anya Ombo Advocates LLP of P. O. Box 15598 - 00400, Nairobi, Kenya

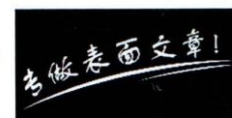

**(210)** : 144592 **(220)** : 02/02/2026 **(300)** : None **(511)** : 41(Education; providing of training.) **(526)** : TOOLRegistration of this mark shall give no right to the exclusive use of the words "TOOL" and "KIT" each separately and apart from the mark as a whole. **(730)** : THE TOOLKIT FOR SKILLS AND INNOVATION LIMITED of P. O. Box 7219, Karen-Kikuyu Highway, Kenya **(740)** : Kairu Mbuthia Law LLP of P. O. Box 6574 - 00100, Nairobi, Kenya



**(210)** : 144593 **(220)** : 02/02/2026 **(300)** : None **(511)** : 2(Paints, varnishes, lacquers; preservatives against rust and against deterioration of wood; colorants, dyes; inks for printing, marking and engraving; raw natural resins; metals in foil and powder form for use in painting, decorating, printing and art;) and 35(Advertising; business management, organization and administration; office functions.) **(526)** : ELITERegistration of this mark shall give no right to the exclusive use of the words "ELITE" and "CLUB" each separately and apart from the mark as a whole. The English translation of the Swahili word "TAJI" is "CROWN". **(730)** : CROWN PAINTS KENYA PLC of P. O Box 78848 - 00507, Nairobi, Kenya **(740)** : Kairu Mbuthia Law LLP of P. O. Box 6574 - 00100, Nairobi, Kenya



**(210)** : 144594 **(220)** : 02/02/2026 **(300)** : None **(511)** : 9(Downloadable and cloud-based software platforms for e-commerce, mobile payments, logistics, inventory control customer engagement,) , 35(Online retail and wholesale services featuring general consumer goods, agricultural inputs, electronics, clothing, health products, and household items; business management and consultancy for vendors and suppliers; marketing, advertising, and promotional services via digital platforms) and 42(Software as a Service (SaaS) featuring cloud-based e-commerce platforms) **(526)** : Registration of this mark shall give no right to the exclusive use of the words "POWERING", "AFRICA" and "ECONOMY" each separately and apart from the mark as a whole. 'ZANOVA' is a coined word with no direct meaning in English. **(730)** : FIRST AFRICA STRATEGIES LTD of P. O. Box 1955 - 00100, Nairobi, Kenya **(740)** : None,



**(210)** : 144605 **(220)** : 03/02/2026 **(300)** : None **(511)** : 43(Services for providing food and drink; temporary accomodation) **(526)** : PIZZERIARegistration of this mark shall give no right to the exclusive use of the word "PIZZERIA" and the article "THE" each separately and apart from the mark as a whole. The mark procedes in series. **(730)** : CITRUS AND OLIVE LTD of P. O. Box 66238 - 00800, Westlands, Kenya **(740)** : None,



**(210)** : 144620 **(220)** : 04/02/2026 **(300)** : None **(511)** : 36(Insurance; financial affairs; monetary affairs; real estate affairs) **(526)** : None **(730)** : FINCAST COMPANY LIMITED of P. O. Box 13147 - 00200, Nairobi, Kenya **(740)** : None,

**ROCKIO**

**(210)** : 144622 **(220)** : 04/02/2026 **(300)** : None **(511)** : 3(Soap) **(526)** : None **(730)** : DERMACOL INDUSTRIES LTD of P. O Box 774 - 00521, Nairobi, Kenya **(740)** : None,

**ZAMANIS PREMIUM BAR SOAP**

**(210)** : 144627 **(220)** : 04/02/2026 **(300)** : None **(511)** : 45(Legal) **(526)** : LAWRegistration of this mark shall give no right to the exclusive use of the word "LAW" separately and apart from the mark as a whole. **(730)** : GEORGE MURUGU of P. O. Box 13715 - 00100, GPO, Nairobi, Kenya **(740)** : None,

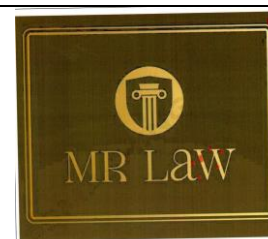

**(210)** : 144632 **(220)** : 04/02/2026 **(300)** : None **(511)** : 36(Real estate affairs) **(526)** : Registration of this mark shall give no right to the exclusive use of the words "STUDENT", "RESIDENCY", the letters "A", "S" and "R" each separately and apart from the mark as a whole. **(730)** : AFRITIME COMPANY LIMITED of P. O. Box 398 - 00902, Muguku business centre, Kikuyu Road, Kabete, Kiambu, Kenya **(740)** : None,



**(210)** : 144639 **(220)** : 05/02/2026 **(300)** : None **(511)** : 5(Livestock's mineral supplements) **(526)** : MASAIRegistration of this mark shall give no right to the exclusive use of the words "MASAI", "NYAMA", "AFYA", "BORA" and the device of a "COW" each separately and apart from the mark as a whole. The English translation of the Swahili words "KWA AFYA BORA NA FAIDA TELE" and "NYAMA" is "For Better Health and More Profits" and "Meat" respectively. **(730)** : BEEF VALLEY VENTURES of P. O. Box 1689 - 20100, Nakuru, Kenya **(740)** : None,

**MASAI NYAMA**  
KWA AFYA BORA NA FAIDA TELE



**(210)** : 144640 **(220)** : 05/02/2026 **(300)** : None **(511)** : 5(Livestock's mineral supplements) **(526)** : ORIGINALRegistration of this mark shall give no right to the exclusive use of the words "ORIGINAL", "MAASAI", "NYAMA", "AFYA", "BORA" and the device of a "COW" each separately and apart from the mark as a whole The English translation of the Swahili words "KWA AFYA BORA NA FAIDA TELE" and "NYAMA" is "For Better Health and More Profits" and "Meat" respectively. **(730)** : BEEF VALLEY VENTURES of P. O. Box 1689 - 20100, Nakuru, Kenya **(740)** : None,

**ORIGINAL**  
**MAASAI NYAMA**  
KWA AFYA BORA NA FAIDA TELE



**(210)** : 144642 **(220)** : 05/02/2026 **(300)** : None **(511)** : 35(Business management and administration; business consultancy and advisory services; leadership and organizational development consultancy; business strategy and planning; entrepreneurship support; business mentoring and coaching; market research and business analysis; human resource and corporate governance consultancy.), 36(Real estate development and investment services; real estate consultancy and management; property acquisition, leasing, and disposal; property valuation and appraisal; real estate advisory and brokerage services; financial consultancy relating to real estate investments and portfolio management.), 41(Education and training services; leadership coaching and development; professional mentoring and coaching; organization of workshops, seminars, conferences, and retreats; provision of educational courses and learning programs ; online and in-person instructional services; publication of educational materials; capacity -building and skills training.) and 42(Information technology consultancy; software design and development; digital transformation and innovation services; systems analysis and integration; cloud computing and data management services; research and development in information technology; provision of technical support and technological advisory services.) **(526)** : Registration of this mark shall give no right to the exclusive use of the letter "N", the surnames "NJERI", "MUCHUNU", the words "GLOBAL" and "KINGS" each separately and apart from the mark as a whole. **(730)** : NJERI MUCHUNU GLOBAL LIMITED of P. O. Box 898, City Square, Kenya **(740)** : None,



**(210)** : 144643 **(220)** : 05/02/2026 **(300)** : None **(511)** : 9(Computer software; downloadable artificial intelligence software; machine learning software; blockchain software; mobile applications; computer hardware.), 35(Business consultancy relating to artificial intelligence and technology; business management consultancy; data processing; business advisory services.) and 42(Scientific and technological services; research and development in artificial intelligence and blockchain; software as a service (SaaS); platform as a service (PaaS); design and development of computer software and hardware.) **(526)** : TOKENRegistration of this mark shall give no right to the exclusive use of the word "TOKEN", the letters "F" , "Y" and the device of the "BLOCKCHAIN" each separately and apart from the mark as a whole **(730)** : BLOCK AI LIMITED of P. O. Box 12248, GPO, Kenya **(740)** : None,



(210) : 144644 (220) : 05/02/2026 (300) : None (511) : 16(Printed materials, photography/ stationery), 30(Confectionery & pastry / condiments), 35(Advertising & business administration), 41(Training & entertainment / sporting & culture), 44(Hygienic & beauty care) and 45(Services rendered by others to meet needs for an individual) (526) : Registration of this mark shall give no right to the exclusive use of the word "WELLNESS" separately and apart from the mark as a whole. (730) : P. PATEL of P. O. Box 63509 - 00619, Kenya (740) : None,

## THE REFUEL WELLNESS

(210) : 144648 (220) : 05/02/2026 (300) : None (511) : 32(Beers; mineral and aerated waters and other non- alcoholic beverages; fruit beverages and fruit juices; syrups and other preparations for making beverages) (526) : SPRINGRegistration of this mark shall give no right to the exclusive use of the words "SPRING" and "WATER" each separately and apart from the mark as a whole. The English translation of the Luo word "HERA" is "Love". (730) : PAUL ARUNGA of P. O. Box 49300 - 00100, Nairobi, Kenya (740) : None,

## HERA SPRING WATER

(210) : 144655 (220) : 05/02/2026 (300) : None (511) : 41(Education; providing of training; entertainment; sporting and cultural activities; betting.) (526) : ARegistration of this mark shall give no right to the exclusive use of the letters "A", "I" and the word "BET" each separately and apart from the mark as a whole. (730) : Kennedy Njui Njau of P. O. Box 417 - 01000, Thika, Kenya (740) : None,



(210) : 144656 (220) : 05/02/2026 (300) : None (511) : 41(Education: providing of training; entertainment; sporting and cultural activities) (526) : KENYARegistration of this mark shall give no right to the exclusive use of the words "KENYA" , "HALL", "FAME", "HONOURING", "GREATNESS" and the devices of a "FLAMING TORCH", "LAUREL" , "WREATH" and "STARS" per se each separately and apart from the mark as a whole. (730) : KENNEDY NJUI NJAU of P. O. Box 417 - 01000, Thika, Kenya (740) : None,



(210) : 144659 (220) : 05/02/2026 (300) : None (511) : 4(Liquefied Petroleum Gas) (526) : GASRegistration of this mark shall give no right to the exclusive use of the word "GAS", the letter "G" and the device of a "FLAME" each separately and apart from the mark as a whole "KINGEN" is a coined word with no specific meaning in English. (730) : AAMMO ENERGY LIMITED of P. O. Box 62 - 40506, Kebirigo, Kenya (740) : None,



(210) : 144660 (220) : 05/02/2026 (300) : None (511) : 12(Vehicles; apparatus for locomotion by land, air or water), 39(Transport; packaging and storage of goods; travel arrangement) and 43(Services for providing food and drink; temporary accommodation) (526) : Registration of this mark shall give no right to the exclusive use of the word "TRAILS" separately and apart from the mark as a whole. The English translation of the word "SIYARA" is a "TRAVELLER". (730) : BASECAMP EXPLORER KENYA LIMITED of P. O. Box 43369 - 00100, Nairobi, Kenya (740) : None,

## SIYARA TRAILS

(210) : 144683 (220) : 06/02/2026 (300) : None (511) : 37(Motor vehicle garage) (526) : FRegistration of this mark shall give no right to the exclusive use of the letters "F", "L" and "V" each separately and apart from the mark as a whole. (730) : AICHEHANG AUTO REPAIR LIMITED of P. O. Box 31519 - 00600, Nairobi, Kenya (740) : None,



**(210)** : 144688 **(220)** : 06/02/2026 **(300)** : None **(511)** : 5(Pharmaceutical and veterinary preparations; sanitary preparations for medical purposes; dietetic substances adapted for medical use, food for babies; plasters, materials for dressings; material for stopping teeth, dental wax; disinfectants; sanitizers.) **(526)** : Registration of this mark shall give no right to the exclusive use of the letters 'D' and "P" each separately and apart from the mark as a whole **(730)** : Rudhav Pharma Limited a Limited liability Company duly incorporated under the laws of Kenya of P.O. Box 39009 - 00623, Nairobi, Kenya **(740)** : None,

**TADAHIGH DP**

**(210)** : 144689 **(220)** : 06/02/2026 **(300)** : None **(511)** : 9(Apparatus and instruments for scientific or research purposes, audiovisual and information technology equipment, as well as safety and life saving equipment.) and 36(Financial, monetary and banking services; insurance services; real estate services.) **(526)** : Registration of this mark shall give no right to the exclusive use of the word "PREMIER" separately and apart from the mark as a whole. The English translation of the Swahili word "FUZU" is succeed. **(730)** : FAMILY BANK LIMITED of P. O. Box 7415 - 00200, Nairobi, Kenya **(740)** : Kimani and Muriithi Associates Advocates of P. O Box 62225 - 00200, Nairobi, Kenya

**FUZU PREMIER**

**(210)** : 144690 **(220)** : 06/02/2026 **(300)** : None **(511)** : 9(Apparatus and instruments for scientific or research purposes, audiovisual and information technology equipment, as well as safety and life saving equipment.) and 36(Financial, monetary and banking services; insurance services; real estate services.) **(526)** : Registration of this mark shall give no right to the exclusive use of the word "PRESTIGE" separately and apart from the mark as a whole. The English translation of the Swahili word "FUZU" is succeed. **(730)** : FAMILY BANK LIMITED of P. O. Box 7415 - 00200, Nairobi, Kenya **(740)** : Kimani and Muriithi Associates Advocates of P. O Box 62225 - 00200, Nairobi, Kenya

**FUZU PRESTIGE**

**(210)** : 144691 **(220)** : 06/02/2026 **(300)** : None **(511)** : 9(Apparatus and instruments for scientific or research purposes, audiovisual and information technology equipment, as well as safety and life saving equipment.) and 36(Financial, monetary and banking services; insurance services; real estate services.) **(526)** : None **(730)** : FAMILY BANK LIMITED of P. O. Box 7415 - 00200, Nairobi, Kenya **(740)** : Kimani and Muriithi Associates Advocates of P. O Box 62225 - 00200, Nairobi, Kenya



**(210)** : 144692 **(220)** : 06/02/2026 **(300)** : None **(511)** : 9(Apparatus and instruments for scientific or research purposes, audiovisual and information technology equipment, as well as safety and life saving equipment.) and 36(Financial, monetary and banking services; insurances services; real estate services.) **(526)** : BANKRegistration of this mark shall give no right to the exclusive use of the words "BANK", "BANCASSURANCE" and "INTERMEDIARY" each separately and apart from the mark as a whole. **(730)** : FAMILY BANK LIMITED of P. O. Box 7415 - 00200, Nairobi, Kenya **(740)** : Kimani and Muriithi Associates Advocates of P. O Box 62225 - 00200, Nairobi, Kenya



**(210)** : 144701 **(220)** : 09/02/2026 **(300)** : None **(511)** : 41(Gaming, lottery, sporting activities) **(526)** : Registration of this Mark shall give no right to the exclusive use of the word" separately and apart from the Mark as a whole. **(730)** : GUCI HOLDINGS COMPANY LIMITED of P. O. Box 63957 -00100, Nairobi, Kenya **(740)** : None,

**STOREBET**

**(210)** : 144703 **(220)** : 09/02/2026 **(300)** : None **(511)** : 36(Financial services) **(526)** : None **(730)** : QUEST RISK SERVICES of P. O. Box 46216 - 00100, Nairobi, Kenya **(740)** : None,

**BLOSSOM**

<b>(210)</b> : 144704 <b>(220)</b> : 09/02/2026 <b>(300)</b> : None <b>(511)</b> : 20(Container not of metal for storage) <b>(526)</b> : None <b>(730)</b> : SAVANNAH MOULDERS LIMITED of P. O. Box 145094 - 00100, Nairobi, Kenya <b>(740)</b> : None,	<b>SUPERTANK</b>
<b>(210)</b> : 144711 <b>(220)</b> : 10/02/2026 <b>(300)</b> : None <b>(511)</b> : 5(Pharmaceuticals and other preparations for medical purposes) <b>(526)</b> : HRegistration of this mark shall give no right to the exclusive use of the letters "H", "K" and "V" each separately and apart from the mark as a whole. <b>(730)</b> : LORDS HEALTHCARE LTD of P. O. Box 49397 - 00100, Nairobi, Kenya <b>(740)</b> : None,	<b>VHK</b>
<b>(210)</b> : 144712 <b>(220)</b> : 10/02/2026 <b>(300)</b> : None <b>(511)</b> : 5(Pharmaceuticals and other preparations for medical purposes) <b>(526)</b> : None <b>(730)</b> : LORDS HEALTHCARE LTD of P. O. Box 49397 - 00100, Nairobi, Kenya <b>(740)</b> : None,	<b>COLITO</b>
<b>(210)</b> : 144713 <b>(220)</b> : 10/02/2026 <b>(300)</b> : None <b>(511)</b> : 36(Financial services) <b>(526)</b> : LIPARegistration of this mark shall give no right to the exclusive use of the words "LIPA" and "BIDHAA" each separately and apart from the mark as a whole The English translation of the Swahili words "LIPA" and "BIDHAA" is "Pay" and "Product" respectively. <b>(730)</b> : Paykit Kenya Limited of P. O. Box 1145 - 00606, Nairobi, Kenya <b>(740)</b> : None,	
<b>(210)</b> : 144738 <b>(220)</b> : 11/02/2026 <b>(300)</b> : None <b>(511)</b> : 5(Agricultural pesticides) <b>(526)</b> : None "SLUTRAP" is a coined word with no meaning in English <b>(730)</b> : KENAGRO SUPPLIERS LTD of P. O. Box 12775 - 00400, Nairobi, Kenya <b>(740)</b> : None,	<b>SLUTRAP</b>
<b>(210)</b> : 144739 <b>(220)</b> : 11/02/2026 <b>(300)</b> : None <b>(511)</b> : 31(Agricultural seeds) <b>(526)</b> : None "AGRIBELL" is a coined word with no meaning in English <b>(730)</b> : AGRIPACK SEEDS LTD of P. O. Box 14679 - 00400, Nairobi, Kenya <b>(740)</b> : None,	<b>AGRIBELL</b>
<b>(210)</b> : 144768 <b>(220)</b> : 11/02/2026 <b>(300)</b> : None <b>(511)</b> : 36(Insurance; financial affairs; monetary affairs; real estate affairs) <b>(526)</b> : None <b>(730)</b> : MONTE HORIZON VENTURES of P. O. Box 17671 - 00100, Nairobi, Kenya <b>(740)</b> : None,	<b>SKYFOCUS</b>
<b>(210)</b> : 144769 <b>(220)</b> : 11/02/2026 <b>(300)</b> : None <b>(511)</b> : 42(Scientific and technological services and research and design relating thereto; industrial analysis and research services, Consultancy relating to the creation and design of websites for e-commerce, hosting of e-commerce platforms on the internet.) <b>(526)</b> : None <b>(730)</b> : GROWTHTRAILS LIMITED of P. O. Box 568 - 00623, Nairobi, Kenya <b>(740)</b> : None,	
<b>(210)</b> : 144771 <b>(220)</b> : 11/02/2026 <b>(300)</b> : None <b>(511)</b> : 35(Advertising; business management; business administration; office functions) and 43(Services for providing food and drink; temporary accommodation, Hotel and restaurant) <b>(526)</b> : Registration of this mark shall give no right to the exclusive use of the word 'OLNG'EJUK' and the devices of "TRADITIONAL MAASAI ORNAMENTS", "THE SHIELD" and "THE SPEAR" each separately and apart from the mark as a whole. The English translation of the Maasai word "OLNG'EJUK" is "NEW". <b>(730)</b> : THE YACHT LIMITED of P. O. Box 28411 - 00100, GPO, Nairobi, Kenya <b>(740)</b> : None,	
<b>(210)</b> : 144772 <b>(220)</b> : 11/02/2026 <b>(300)</b> : None <b>(511)</b> : 35(Advertising; business management; business administration; office functions.) and 36(Digital Credit Provider, Loan Granting, Mobile Loans, Non-Deposit Taking Credit Provider, Micro Credit, Financial Services Arrangers & Advisors, Financing of Businesses and Individuals, Insurance; financial affairs; monetary affairs; real estate affairs. ) <b>(526)</b> : CASHRegistration of this mark shall give no right to the exclusive use of the words "CASH" and "MART" each separately and apart from the mark as a whole. <b>(730)</b> : CASHMART CAPITAL LIMITED of P. O. Box 21249 - 00100, Nairobi, Kenya <b>(740)</b> : None,	

**(210)** : 144777 **(220)** : 12/02/2026 **(300)** : None **(511)** : 45(Political lobbying services) **(526)** : Registration of this mark shall give no right to the exclusive use of the device of a "GAS CYLINDER" and "FLAME" each separately and apart from the mark as a whole The English translation of the Kikuyu word "KABA" is "BETTER OF". The English translation of the slang word "KAMEKO" is "Gas". The English translation of the Kiswahili words "HAKUNA KUBAHATISHA" is "No Risking". **(730)** : NGUJIRI CONSULTING LTD of P. O. Box 55529 - 00200, Nairobi, Kenya **(740)** : None,



**(210)** : 144779 **(220)** : 12/02/2026 **(300)** : None **(511)** : 9(Scientific, research and monitoring apparatus and instruments; web-access software for cross-utility monitoring and analysis; 10T sensors for monitoring electricity, water, medical gases, lpg temperature, and fuel consumption; electric meters, smart meters , flow meters, pressure sensors; temperature and humidity sensors for cold chain monitoring; vehicle telematics devices and GPS tracking apparatus; sensors for detecting fuel theft and consumption anomalies; data processing apparatus for predictive analytics; computer software for detecting fraud, waste, and inefficiencies in utility consumption; apparatus for monitoring motor performance and engine parameters; electronic monitoring devices for generators, pumps, and vehicle engines; web-access software for resource optimization analytics and reporting), 11(Apparatus for monitoring the performance of heating, cooling, and ventilation equipment; monitoring devices for HVAC systems; sensors for monitoring generator performance and engine parameters; monitoring apparatus for lift motors and elevator systems; apparatus for monitoring refrigeration units and cold chain equipment; monitoring devices for water pumps and distribution systems; apparatus for optimizing energy consumption in lighting installations; sensors integrated with lighting installations for occupancy detection; monitoring apparatus for solar panel performance; temperature and pressure monitoring apparatus for utility systems), 35(Business data analysis services; compilation and systematization of utility consumption data into computer databases; cost-benefit analysis for utility optimization initiatives; business consulting services relating to facility resource management; providing business intelligence through data analytics for operational efficiency; return on investment (ROT) calculation and tracking services; department-level cost allocation and tracking services ; business auditing relating to utility expenditure and efficiency; compilation of statistics for business or commercial purposes related to resource management; data processing services for financial impact analysis of optimization measures; business management consulting services for commercial and industry facilities focusing on operational efficiency, providing commercial information and advice for utility optimization and cost reduction strategies), 37(Installation services for utility monitoring sensors and 10T devices; installation of light intensity sensors and occupancy sensors for energy optimization; installation of smart meters and flow monitoring equipment ; installation services for temperature monitoring systems in cold chain applications; maintenance and repair of utility monitoring equipment; calibration services for sensors and monitoring devices; installation of vehicle telematics and fleet monitoring devices ; technical support services for installed monitoring hardware; retrofitting services for energy efficiency improvements in existing facilities; installation of variable frequency drives (VFDs) on HVAC systems and pumps; consultancy relating to the installation of utility monitoring systems; preventive maintenance services based on predictive analytics) and 42(Software as a service (SaaS) featuring software for integrated resource management and optimization;



Data-Driven Resource Optimization

platform as a service (PaaS) for cross-utility monitoring and analytics; engineering services relating to energy efficiency and utility optimization; scientific and technological research in the field of utility consumption optimization; technological consulting services for healthcare facility management; computer programming services for predictive consumption analytics; design and development of computer software for facility monitoring; providing online non-downloadable software for real-time utility tracking and analysis; data analytics services for identifying operational inefficiencies and optimization opportunities; industrial analysis and research services for utility efficiency, technical data analysis services relating to utility consumption patterns; predictive maintenance analytics for motors, generators, and equipment; carbon footprint calculation and environmental impact analysis services) (526) : COMPLEXRegistration of this mark shall give no right to the exclusive use of the words "COMPLEX", "DATA-DRIVEN", "RESOURCE", "OPTIMIZATION" and the device of the "DATA NETWORK" per se each separately and apart from the mark as a whole. (730) : SOUTHERN COMPLEX LIMITED of P. O. Box 7101- 40100, Kisumu, Kenya (740) : Michael Otieno Okello O M Okello Advocates of P. O. Box 86140 - 00200, Nairobi, Kenya

(210) : 144800 (220) : 12/02/2026 (300) : None (511) : 39(Parking services) (526) : PARKRegistration of this mark shall give no right to the exclusive use of the word "PARK" and letter "X" each separately and apart from the mark as a whole (730) : PRECISION CAPITAL LIMITED of P. O. Box 28088 -00100, Nairobi, Kenya (740) : None,



(210) : 144801 (220) : 12/02/2026 (300) : None (511) : 3(Non-medicated cosmetics and toiletry preparations; non-medicated dentifrices; perfumery, essential oils; bleaching preparations and other substances for laundry use; cleaning, polishing, scouring and abrasive preparations; hair oil; lotion; air freshners.) (526) : None "JAWAHIRA" is an Arabic feminine name meaning "Jewels" Or "Gems" and can also mean "Essence" Or "Preciousness". The transliteration of the Arabic characters forming part of the mark is derived from the Arabic word "JAWHAR". The Arabic word in the logo means "JEWEL" or "PRECIOUS GEM". (730) : MUWADDA TRADING CO. LTD of P. O. Box 7996 - 00300, 3rd Avenue Eastleigh, Nairobi, Kenya (740) : Jimmy & Company Advocates of P. O. Box 2622 - 00100, Nairobi, Kenya



(210) : 144802 (220) : 12/02/2026 (300) : None (511) : 3(Non-medicated cosmetics and toiletry preparations; non-medicated dentifrices; perfumery, essential oils; bleaching preparations and other substances for laundry use; cleaning, polishing, scouring and abrasive preparations; hair oil; lotion; air freshners.) (526) : ORIGINALRegistration of this mark shall give no right to the exclusive use of the word "ORIGINAL" separately and apart from the mark as a whole. The word "MUWADDA" means "Permanent Love" or "Lovely". (730) : MUWADDA TRADING CO. LTD of P. O. Box 7996 - 00300, 3rd Avenue Eastleigh, Nairobi, Kenya (740) : Jimmy & Company Advocates of P. O. Box 2622 - 00100, Nairobi, Kenya



(210) : 144805 (220) : 12/02/2026 (300) : None (511) : 16(Paper and cardboard; printed matter; bookbinding material; photographs; stationery and office requisites, except furniture; adhesives for stationery or household purposes; drawing materials and materials for artists; paintbrushes; instructional and teaching materials; plastic sheets, films and bags for wrapping and packaging ; printers' type, printing blocks ), 35(Advertising; business management, organization and administration; office functions.) and 41(Education; providing of



training; entertainment; sporting and cultural activities ) (526) : Registration of this mark shall give no right to the exclusive use of the words "STAFF", "RETIREMENT", "BENEFITS", "LIFE", "ASSURANCE", "SCHEME", the letters "A", "B", "E", "K", "N" and "S" each separately and apart from the mark as a whole. (730) : KASNEB STAFF RETIREMENT BENEFITS AND LIFE ASSURANCE SCHEME of P. O. Box 41362 - 00100, Nairobi, Kenya (740) : None,

(210) : 144806 (220) : 12/02/2026 (300) : None (511) : 16(Paper and cardboard; printed matter; bookbinding material; photographs; stationery and office requisites, except furniture; adhesives for stationery or household purposes; drawing materials and materials for artists; paintbrushes; instructional and teaching materials; plastic sheets, films and bags for wrapping and packaging ; printers' type, printing blocks), 35(Advertising; business management, organization and administration; office functions.) and 41(Education; providing of training; entertainment; sporting and cultural activities) (526) : STAFFRegistration of this mark shall give no right to the exclusive use of the words "STAFF", "RETIREMENT", "BENEFITS", "LIFE", "ASSURANCE", "SCHEME", the letters "A", "B", "E", "K", "N", "S" and the numerals "0", "1", "2" each separately and apart from the mark as a whole. (730) : KASNEB STAFF RETIREMENT BENEFITS AND LIFE ASSURANCE SCHEME of P. O. Box 41362 - 00100, Nairobi, Kenya (740) : None,



(210) : 144807 (220) : 12/02/2026 (300) : None (511) : 30(Beverages with coffee, cocoa, chocolate or tea base; - cereals prepared for human consumption, for example, oat flakes, corn chips, husked barley, bulgur, muesli; - pizza, pies, sandwiches; - chocolate-coated nuts; flavourings, other than essential oils, for food or beverages.), 35(The bringing together, for the benefit of others, of a variety of goods, excluding the transport thereof, enabling customers to conveniently view and purchase those goods; such services may be provided by retail stores, wholesale outlets, through vending machines, mail order catalogues or by means of electronic media, for example, through websites or television shopping programmes; - advertising, marketing and promotional services, for example, distribution of samples, development of advertising concepts, writing and publication of publicity texts; - shop window dressing; - public relations services; - production of teleshopping programmes; - organization of trade fairs and exhibitions for commercial or advertising purposes; -search engine optimization for sales promotion; - commercial assistance services, for example, personnel recruitment, negotiation of business contracts for others, cost price analysis, import-export agency services; administration services relating to business transactions and financial records, for example, book-keeping, drawing up of statements of accounts, business and financial auditing, business appraisals, tax preparation and filing services; - commercial administration of the licensing of the goods and services of others; - services consisting of the registration, transcription, composition, compilation or systematization of written communications and registrations, and also the compilation of mathematical or statistical data; office functions, for example, appointment scheduling and reminder services, data search in computer files for others, computerized file management, tele hone switchboard services.) and 41(organization of exhibitions for cultural or educational purposes, arranging and conducting of conferences, congresses and symposiums; - translation and language interpretation services; - publication of books and texts, other than publicity texts; - news reporters services, photographic reporting; photography; - film direction and production services, other than for advertising films; - cultural, educational or entertainment services

WebBanda

provided by amusement parks, circuses, zoos, art galleries and museums; - sports and fitness training services; - training of animals; - online gaming services; gambling services, organization of lotteries; - ticket reservation and booking services for entertainment, educational and sporting events; - certain writing services, for example, screen play writing , song writing.) (526) : None "WEBANDA" is a coined word derived from the kiswahili word "Kibanda" (730) : CAPWELL INDUSTRIES LIMITED of P. O. Box 746 - 01000, Thika, Kenya (740) : None,

(210) : 144808 (220) : 12/02/2026 (300) : None (511) : 42(Scientific and technological services and research and design relating thereto; industrial analysis and research services; design and development of computer hardware and software) (526) : CONNECT Registration of this mark shall give no right to the exclusive use of the word "CONNECT" separately and apart from the mark as a whole. The English translation of the Swahili word "FAHARI" is "Pride". (730) : LIGIS CONSULTING of P. O. Box 1762 - 00900, Kiambu, Kenya (740) : None,



(210) : 144811 (220) : 12/02/2026 (300) : None (511) : 41(Education; providing of training; entertainment; sporting and cultural activities) (526) : DIGITAL Registration of this mark shall give no right to the exclusive use of the words "DIGITAL" and "LEARNING" each separately and apart from the mark as a whole. (730) : PIUS ODHIAMBO of P. O. Box 17586 - 00100, Nairobi, Kenya (740) : None,



(210) : 144815 (220) : 12/02/2026 (300) : None (511) : 5(Veterinary preparations) (526) : None (730) : MEDINA CHEMICALS LTD of P. O. Box 47346 - 00100, Nairobi, Kenya (740) : None,

**BROMIDIUM**

(210) : 144824 (220) : 12/02/2026 (300) : None (511) : 5(Pharmaceuticals and medical preparations) (526) : None (730) : HARLEYS LIMITED of P. O. Box 42718 - 00100, Nairobi, Kenya (740) : None,

**HYCONTRAX**

(210) : 144827 (220) : 16/02/2026 (300) : None (511) : 42(Scientific and technological services and research and design relating thereto; industrial analysis and industrial research services; design and development of computer hardware and software.) (526) : None "JOBU" is a coined word with no specific meaning in English. (730) : BROADBAND COMMUNICATIONS NETWORK LIMITED of P. O. Box 10840 - 00100, Kenya (740) : None,

**JOBU**

(210) : 144831 (220) : 16/02/2026 (300) : None (511) : 35(Advertising, business management, business administration, business appraisal services, business consultancy services, business strategy services, business secretarial services, business advisory services, business Inquiry services, office functions) and 41(Education, providing of training, entertainment, sporting and cultural activities, organizing of educational events, conducting of educational events, arranging of educational events.) (526) : Registration of this mark shall give no right to the exclusive use of the words "NAIROBI", "INVESTMENT", "CONFERENCE" and "EXPO" each separately and apart from the mark as a whole. (730) : CREDENCE AFRICA NETWORK of P. O. Box 568 - 00623, Applewood, Adams, Nairobi, Kenya (740) : None,

**NAIROBI INVESTMENT  
CONFERENCE & EXPO**

(210) : 144832 (220) : 16/02/2026 (300) : None (511) : 35(Advertising, business management, business administration, business appraisal services, business consultancy services, business strategy services, business secretarial services, business advisory services, business Inquiry services, office functions) and 41(Education, providing of training, entertainment, sporting and cultural activities, organizing of educational events, conducting of educational events, arranging of educational events.) (526) : Registration of this mark shall give no right to the exclusive use of the words "WOMEN", "WEALTH", "BREAKFAST", "SUMMIT", "CONFERENCE", "EXPO" and "LUNCHEON" each separately and apart from the mark as a whole. (730) : CREDENCE AFRICA NETWORK

**WOMEN & WEALTH  
BREAKFAST SUMMIT  
EXPO CONFERENCE &  
LUNCHEON**

of P. O. Box 568 - 00623, Applewood, Adams, Nairobi, Kenya (740) : None,

(210) : 144833 (220) : 16/02/2026 (300) : None (511) : 35(Advertising, business management, business administration, business appraisal services, business consultancy services, business strategy services, business secretarial services, business advisory services, business inquiry services, office functions) and 41(Education, providing of training, entertainment, sporting and cultural activities, organizing of educational events, conducting of educational events, arranging of educational events.) (526) : Registration of this mark shall give no right to the exclusive use of the word "FESTIVAL" separately and apart from the mark as a whole. (730) : CREDESCENCE AFRICA NETWORK of P. O. Box 568 - 00623, Applewood, Adams, Nairobi, Kenya (740) : None,

## COOPS FESTIVAL

(210) : 144836 (220) : 16/02/2026 (300) : None (511) : 41(Education; providing of training; entertainment services; betting and gambling, sporting services, music activities, mobile games and cultural activities.) (526) : GAMERegistration of this mark shall give no right to the exclusive use of the words "GAME", "WINGER" and "STUDIOS" each separately and apart from the mark as a whole. (730) : LILAC SOFTWARE DEVELOPERS LIMITED of P. O. Box 1352 - 00800, Nairobi, Kenya (740) : None,

## WINGER GAME STUDIOS

(210) : 144837 (220) : 16/02/2026 (300) : None (511) : 35(Advertising; business management, organization and administration) and 41(Education; providing of training; entertainment; sporting and cultural activities; film distribution, film production; production of shows) (526) : KENYANRegistration of this mark shall give no right to the exclusive use of the words "KENYAN", "KITCHEN" and the phrases "PROMOTING SUSTAINABLE FOOD SYSTEMS" each separately and apart from the mark as a whole. (730) : KENYAN KITCHEN LIMITED of P. O. Box 14042 - 00100, Nairobi, Kenya (740) : Kairu Mbuthia Law LLP of P.O. Box 6574 - 00100, Nairobi, Kenya

**Kenyan  
Kitchen**  
promoting sustainable food systems

(210) : 144838 (220) : 16/02/2026 (300) : None (511) : 36(Financial services; digital credit provider; loan granting; mobile loans; micro credit; financial services arrangers and advisors; monetary affairs.) (526) : CREDITRegistration of this mark shall give no right to the exclusive use of the words "CREDIT" and "LIMITED" each separately and apart from the mark as a whole. (730) : ROSEMARY WAIRIMU GACHEMI of P. O. Box 1392 - 00618, Nairobi, Kenya (740) : None,

## NIMS CREDIT LIMITED

(210) : 144839 (220) : 16/02/2026 (300) : None (511) : 5(Veterinary preparations; amino acids for veterinary purposes, dietetic substances adapted for veterinary use, biological, bacterial and bacteriological preparations for medical and veterinary use, biological tissue cultures and chemical preparations for veterinary purposes, chemical reagents for medical or veterinary purposes, cultures of microorganisms for medical and veterinary use, enzyme preparations for veterinary purposes, greases and lotions for veterinary purposes) (526) : LIQUIDRegistration of this mark shall give no right to the exclusive use of the word "LIQUID" separately and apart from the mark as a whole. (730) : VETZEN ENTERPRISES LTD A limited liability company duly incorporated under the laws of Kenya of P. O. Box 228 - 00623, Nairobi, Kenya (740) : None,

**ZINCUR**

(210) : 144840 (220) : 16/02/2026 (300) : None (511) : 5(Veterinary preparations; amino acids for veterinary purposes, dietetic substances adapted for veterinary use, biological, bacterial and bacteriological preparations for medical and veterinary use, biological tissue cultures and chemical preparations for veterinary purposes, chemical reagents for medical or veterinary purposes, cultures of microorganisms for

**Meatgrow**  
Liquid

---

medical and veterinary use, enzyme preparations for veterinary purposes, greases and lotions for veterinary purposes) (526) : MEATRegistration of this mark shall give no right to the exclusive use of the words "MEAT", "GROW", "LIQUID" and the device of "ANIMALS" each separately and apart from the mark as a whole. (730) : VETZEN ENTERPRISES LTD A limited liability company duly incorporated under the laws of Kenya of P. O. Box 228 - 00623, Nairobi, Kenya (740) : None,

---

(210) : 144841 (220) : 16/02/2026 (300) : None (511) : 5(Veterinary preparations; amino acids for veterinary purposes, dietetic substances adapted for veterinary use, biological, bacterial and bacteriological preparations for medical and veterinary use, biological tissue cultures and chemical preparations for veterinary purposes, chemical reagents for medical or veterinary purposes, cultures of microorganisms for medical and veterinary use, enzyme preparations for veterinary purposes, greases and lotions for veterinary purposes) (526) : MEATRegistration of this mark shall give no right to the exclusive use of the words "MEAT", "BOOST" and "POWDER" each separately and apart from the mark as a whole. (730) : VETZEN ENTERPRISES LTD A limited liability company duly incorporated under the laws of Kenya of P. O. Box 228 - 00623, Nairobi, Kenya (740) : None,



---

(210) : 144842 (220) : 16/02/2026 (300) : None (511) : 5(Veterinary preparations; amino acids for veterinary purposes, dietetic substances adapted for veterinary use, biological, bacterial and bacteriological preparations for medical and veterinary use, biological tissue cultures and chemical preparations for veterinary purposes, chemical reagents for medical or veterinary purposes, cultures of microorganisms for medical and veterinary use, enzyme preparations for veterinary purposes, greases and lotions for veterinary purposes) (526) : LIQUIDRegistration of this mark shall give no right to the exclusive use of the word "LIQUID" separately and apart from the mark as a whole. (730) : VETZEN ENTERPRISES LTD A limited liability company duly incorporated under the laws of Kenya of P. O. Box 228 - 00623, Nairobi, Kenya (740) : None,



---

(210) : 144843 (220) : 16/02/2026 (300) : None (511) : 5(Veterinary preparations; amino acids for veterinary purposes, dietetic substances adapted for veterinary use, biological, bacterial and bacteriological preparations for medical and veterinary use, biological tissue cultures and chemical preparations for veterinary purposes, chemical reagents for medical or veterinary purposes, cultures of microorganisms for medical and veterinary use, enzyme preparations for veterinary purposes, greases and lotions for veterinary purposes) (526) : Registration of this mark shall give no right to the exclusive use of the words "WOUND" and "OINTMENT" each separately and apart from the mark as a whole. (730) : VETZEN ENTERPRISES LTD A limited liability company duly incorporated under the laws of Kenya of P. O. Box 228 - 00623, Nairobi, Kenya (740) : None,



---

(210) : 144844 (220) : 16/02/2026 (300) : None (511) : 5(Veterinary preparations; amino acids for veterinary purposes, dietetic substances adapted for veterinary use, biological, bacterial and bacteriological preparations for medical and veterinary use, biological tissue cultures and chemical preparations for veterinary purposes, chemical reagents for medical or veterinary purposes, cultures of microorganisms for medical and veterinary use, enzyme preparations for veterinary purposes, greases and lotions for veterinary purposes) (526) : Registration of this mark shall give no right to the exclusive use of the word "LIQUID" separately and apart from the mark as a whole. (730) :

---



---

VETZEN ENTERPRISES LTD A limited liability company duly incorporated under the laws of Kenya of P. O. Box 228 - 00623, Nairobi, Kenya (740) : None,

---

(210) : 144845 (220) : 16/02/2026 (300) : None (511) : 5(Veterinary preparations; amino acids for veterinary purposes, dietetic substances adapted for veterinary use, biological, bacterial and bacteriological preparations for medical and veterinary use, biological tissue cultures and chemical preparations for veterinary purposes, chemical reagents for medical or veterinary purposes, cultures of microorganisms for medical and veterinary use, enzyme preparations for veterinary purposes, greases and lotions for veterinary purposes) (526) Registration of this mark shall give no right to the exclusive use of the word "LIQUID" separately and apart from the mark as a whole. (730) : VETZEN ENTERPRISES LTD A limited liability company duly incorporated under the laws of Kenya of P. O. Box 228 - 00623 LIQUID, Nairobi, Kenya (740) : None,

---

**COCCISAN**  
Liquid

(210) : 144846 (220) : 16/02/2026 (300) : None (511) : 5(Veterinary preparations; amino acids for veterinary purposes, dietetic substances adapted for veterinary use, biological, bacterial and bacteriological preparations for medical and veterinary use, biological tissue cultures and chemical preparations for veterinary purposes, chemical reagents for medical or veterinary purposes, cultures of microorganisms for medical and veterinary use, enzyme preparations for veterinary purposes, greases and lotions for veterinary purposes) (526) : LIQUID Registration of this mark shall give no right to the exclusive use of the word "LIQUID" separately and apart from the mark as a whole. (730) : VETZEN ENTERPRISES LTD A limited liability company duly incorporated under the laws of Kenya of P. O. Box 228 - 00623, Nairobi, Kenya (740) : None,

---

**TYMPAMOR**  
Liquid

(210) : 144847 (220) : 16/02/2026 (300) : None (511) : 5(Veterinary preparations; amino acids for veterinary purposes, dietetic substances adapted for veterinary use, biological, bacterial and bacteriological preparations for medical and veterinary use, biological tissue cultures and chemical preparations for veterinary purposes, chemical reagents for medical or veterinary purposes, cultures of microorganisms for medical and veterinary use, enzyme preparations for veterinary purposes, greases and lotions for veterinary purposes) (526) : None (730) : VETZEN ENTERPRISES LTD A limited liability company duly incorporated under the laws of Kenya of P. O. Box 228 - 00623, Nairobi, Kenya (740) : None,

---

**CURA-LIV**

(210) : 144848 (220) : 16/02/2026 (300) : None (511) : 5(Veterinary preparations; amino acids for veterinary purposes, dietetic substances adapted for veterinary use, biological, bacterial and bacteriological preparations for medical and veterinary use, biological tissue cultures and chemical preparations for veterinary purposes, chemical reagents for medical or veterinary purposes, cultures of microorganisms for medical and veterinary use, enzyme preparations for veterinary purposes, greases and lotions for veterinary purposes) (526) : None (730) : VETZEN ENTERPRISES LTD A limited liability company duly incorporated under the laws of Kenya of P. O. Box 228 - 00623, Nairobi, Kenya (740) : None,

---

**CURA-CAL**

---

(210) : 144849 (220) : 16/02/2026 (300) : None (511) : 5(Veterinary preparations; amino acids for veterinary purposes, dietetic substances adapted for veterinary use, biological, bacterial and bacteriological preparations for medical and veterinary use, biological tissue cultures and chemical preparations for veterinary purposes, chemical reagents for medical or veterinary purposes, cultures of microorganisms for medical and veterinary use, enzyme preparations for veterinary purposes, greases and lotions for veterinary purposes) (526) : LIQUID Registration of this mark shall give no right to the exclusive use of the word "LIQUID" separately and apart from the mark as a whole. (730) : VETZEN ENTERPRISES LTD A limited liability company duly incorporated under the laws of Kenya of P. O. Box 228 - 00623, Nairobi, Kenya (740) : None,

---



(210) : 144850 (220) : 16/02/2026 (300) : None (511) : 5(Veterinary preparations; amino acids for veterinary purposes, dietetic substances adapted for veterinary use, biological, bacterial and bacteriological preparations for medical and veterinary use, biological tissue cultures and chemical preparations for veterinary purposes, chemical reagents for medical or veterinary purposes, cultures of microorganisms for medical and veterinary use, enzyme preparations for veterinary purposes, greases and lotions for veterinary purposes) (526) : Registration of this mark shall give no right to the exclusive use of the words "STRESS" and "CURE" each separately and apart from the mark as a whole. (730) : VETZEN ENTERPRISES LTD A limited liability company duly incorporated under the laws of Kenya of P. O. Box 228 - 00623, Nairobi, Kenya (740) : None,

---

**Stress-Cure**

(210) : 144851 (220) : 16/02/2026 (300) : None (511) : 30(Tea; leaf tea; tea leaves; black tea; green tea; white tea; red tea; organic tea; herbal tea; fruit tea; spiced tea; tisanes; herbal tisanes; fruit tisanes; spiced tisanes; tea essences for foodstuffs, except etheric essences and essential oils; tea extracts; instant tea; tea mixtures; mixed plant tea; infusions; infusions for making beverages; tea bags; sachets; string and tag bags; envelope tea bags; pyramid infusers; iced tea; tea beverages; beverages having tea as a main ingredient; tea-flavoured beverages; tea products; cocoa; cocoa based beverages; cocoa beverages with milk; cocoa substitutes; beverages containing chocolate; chocolate beverages containing milk; drinking chocolate; spices; sugar; coffee; coffee based beverages; coffee beverages with milk; coffee extracts; coffee based preparations for making non- alcoholic coffee-based beverages; coffee syrup for food purposes; coffee concentrate (instant coffee); coffee extract for food flavouring purposes; chicory; chicory and chicory mixtures, all for use as substitutes for coffee; flavourings for beverages; herbal preparations for making beverages; herbal beverages; ice beverages; ice cream drinks; prepared beverages containing the aforesaid goods; sachets containing the aforesaid goods for use with beverage preparation machines. ) and 35(Marketing services; advertising services; publicity services; business management services; business assistance; business administration; dissemination of advertising matter; promotional services; operation of sales and/or promotional incentive schemes; supervision and management of sales and/or promotional incentive schemes; franchising (business advisory services relating to-); commercial trading; consumer information services; import, export services; organisation of exhibitions for commercial or advertising purposes; demonstration of goods; presentation of goods on communication media for retail purposes; office machines and equipment rental; rental of vending machines; retail services connected with the sale of agricultural, horticultural and forestry products, trees, grains, seeds, flowers, fruits, vegetables

---

*ChairDIRECT International*

, spices, drinks, non-alcoholic drinks and beverages; wholesale services connected with the sale of agricultural, horticultural and forestry products, trees, grains, seeds, flowers, fruits, vegetables, spices and beverages; the bringing together in a retail outlet, supermarket, café for the benefit of others of a variety of goods, namely agricultural, horticultural and forestry products, trees, grains, seeds, flowers, fruits, vegetables, spices, drinks, nonalcoholic drinks and beverages thereby to enable customers conveniently to view and purchase those goods; the bringing together in a wholesale outlet for the benefit of others of a variety of goods, namely agricultural, horticultural and forestry products, trees, grains, seeds, flowers, fruits, vegetables, spices, drinks, non-alcoholic drinks and beverages, thereby to enable customers conveniently to view and purchase those goods; the bringing together, for the benefit of others, of a variety of descriptions of, or of images of agricultural, horticultural and forestry products, trees, grains, seeds, flowers, fruits, vegetables, spices, drinks, non-alcoholic drinks and beverages in a catalogue, thereby to enable customers conveniently to view and to purchase those goods by mail order; the bringing together, for the benefit of others, of a variety of descriptions of, or of images of, agricultural, horticultural and forestry products, trees, grains, seeds, flowers, fruits, vegetables, spices, drinks, non-alcoholic drinks and beverages, on an Internet website, thereby to enable customers conveniently to view and to purchase those goods by means of telecommunications; business advisory, negotiating and representational services; provision of information, advice, assistance and consultancy services relating to all the aforesaid; information, advice and consultancy services relating to the sale of agricultural, horticultural and forestry products, trees, grains, seeds, flowers, fruits, vegetables, spices, drinks, non-alcoholic drinks and beverages; tea shops.) **(526)** : Registration of this mark shall give no right to the exclusive use of the word "INTERNATIONAL" separately and apart from the mark as a whole. **(730)** : DACHOGA HOLDINGS LIMITED A limited liability company duly incorporated under the laws of Kenya of P. O. Box 6480 - 00200, Nairobi, Kenya **(740)** : None,

**(210)** : 144852 **(220)** : 16/02/2026 **300)** : None **(511)** : 30(Tea; leaf tea; tea leaves; black tea; green tea; white tea; red tea; organic tea; herbal tea; fruit tea; spiced tea; tisanes; herbal tisanes; fruit tisanes; spiced tisanes; tea essences for foodstuffs, tea extracts; instant tea; tea mixtures; mixed plant tea; infusions; infusions for making beverages; tea bags; sachets; string and tag bags; envelope tea bags; pyramid infusers; iced tea; tea beverages; beverages having tea as a main ingredient; tea-flavoured beverages; tea products; flavourings for beverages; herbal preparations for making beverages; herbal beverages; ice beverages; ice cream drinks) and 35(Marketing services; advertising services; publicity services; business management services; business assistance; business administration; dissemination of advertising matter; promotional services; operation of sales and/or promotional incentive schemes; supervision and management of sales and/ or promotional incentive schemes; franchising (business advisory services relating to-); commercial trading; consumer information services; import, export services; organisation of exhibitions for commercial or advertising purposes; demonstration of goods; presentation of goods on communication media for retail purposes; office machines and equipment rental; rental of vending machines; retail services connected with the sale of agricultural, horticultural and forestry products, trees, grains, seeds, flowers, fruits, vegetables, spices, drinks, non-alcoholic drinks and beverages; wholesale services connected with the sale of agricultural, horticultural and forestry products, trees, grains, seeds, flowers, fruits, vegetables, spices and



beverages; the bringing together in a retail outlet, supermarket, café for the benefit of others of a variety of goods, namely agricultural , horticultural and forestry products, trees, grains, seeds, flowers, fruits, vegetables, spices, drinks, non-alcoholic drinks and beverages thereby to enable customers conveniently to view and purchase those goods; the bringing together in a wholesale outlet for the benefit of others of a variety of goods, namely agricultural, horticultural and forestry products, trees, grains, seeds, flowers, fruits, vegetables, spices, drinks, non-alcoholic drinks and beverages, thereby to enable customers conveniently to view and purchase those goods; the bringing together, for the benefit of others, of a variety of descriptions of, or of images of agricultural, horticultural and forestry products, trees, grains, seeds, flowers, fruits, vegetables, spices, drinks, non-alcoholic drinks and beverages in a catalogue, thereby to enable customers conveniently to view and to purchase those goods by mail order; the bringing together, for the benefit of others, of a variety of descriptions of, or of images of, agricultural, horticultural and forestry products, trees, grains, seeds, flowers, fruits, vegetables, spices, drinks, non-alcoholic drinks and beverages, on an Internet website, thereby to enable customers conveniently to view and to purchase those goods by means of telecommunications; business advisory, negotiating and representational services; provision of information, advice, assistance and consultancy services relating to all the aforesaid; information, advice and consultancy services relating to the sale of agricultural, horticultural and forestry products, trees, grains, seeds, flowers, fruits, vegetables, spices, drinks , non- alcoholic drinks and beverages; tea shops.) **(526)** : Registration of this mark shall give no right to the exclusive use of the words "CHAI", "LIMITED" and the device of "TEA LEAVES" each separately and apart from the mark as a whole. The English translation of the the Swahili word "CHAI" is "Tea". **(730)** : DACHOGA HOLDINGS LIMITED A limited liability company duly incorporated under the laws of Kenya of P. O. Box 6480 - 00200, Nairobi, Kenya **(740)** : None,

**(210)** : 144853 **(220)** : 16/02/2026 **(300)** : None **(511)** : 30(Tea; leaf tea; tea leaves; black tea; green tea; white tea; red tea; organic tea; herbal tea; fruit tea; spiced tea; tisanes; herbal tisanes; fruit tisanes; spiced tisanes; tea essences for foodstuffs, except etheric essences and essential oils; tea extracts; instant tea; tea mixtures; mixed plant tea; infusions; infusions for making beverages; tea bags; sachets; string and tag bags; envelope tea bags; pyramid infusers; iced tea; tea beverages; beverages having tea as a main ingredient; tea-flavoured beverages; tea products; cocoa; cocoa based beverages; cocoa beverages with milk; cocoa substitutes; beverages containing chocolate; chocolate beverages containing milk; drinking chocolate; spices; sugar; coffee; coffee based beverages; coffee beverages with milk; coffee extracts; coffee based preparations for making non- alcoholic coffee-based beverages; coffee syrup for food purposes; coffee concentrate (instant coffee); coffee extract for food flavouring purposes; chicory; chicory and chicory mixtures, all for use as substitutes for coffee; flavourings for beverages; herbal preparations for making beverages; herbal beverages; ice cream drinks; prepared beverages containing the aforesaid goods; sachets containing the aforesaid goods for use with beverage preparation machines.) and 35(Marketing services; advertising services; publicity services; business management services; business assistance; business administration; dissemination of advertising matter; promotional services; operation of sales and/or promotional incentive schemes; supervision and management of sales and/or promotional incentive schemes; franchising (business advisory services relating to-); commercial trading; consumer information



services; import, export services; organisation of exhibitions for commercial or advertising purposes; demonstration of goods; presentation of goods on communication media for retail purposes; office machines and equipment rental; rental of vending machines; retail services connected with the sale of agricultural, horticultural and forestry products, trees, grains, seeds, flowers, fruits, vegetables, spices, drinks, non-alcoholic drinks and beverages; wholesale services connected with the sale of agricultural, horticultural and forestry products, trees, grains, seeds, flowers, fruits, vegetables, spices and beverages; the bringing together in a retail outlet, supermarket, café for the benefit of others of a variety of goods, namely agricultural, horticultural and forestry products, trees, grains, seeds, flowers, fruits, vegetables, spices, drinks, non-alcoholic drinks and beverages thereby to enable customers conveniently to view and purchase those goods; the bringing together in a wholesale outlet for the benefit of others of a variety of goods, namely agricultural, horticultural and forestry products, trees, grains, seeds, flowers, fruits, vegetables, spices, drinks, non-alcoholic drinks and beverages, thereby to enable customers conveniently to view and purchase those goods; the bringing together, for the benefit of others, of a variety of descriptions of, or of images of agricultural, horticultural and forestry products, trees, grains, seeds, flowers, fruits, vegetables, spices, drinks, non-alcoholic drinks and beverages in a catalogue, thereby to enable customers conveniently to view and to purchase those goods by mail order; the bringing together, for the benefit of others, of a variety of descriptions of, or of images of, agricultural, horticultural and forestry products, trees, grains, seeds, flowers, fruits, vegetables, spices, drinks, non-alcoholic drinks and beverages, on an Internet website, thereby to enable customers conveniently to view and to purchase those goods by means of telecommunications; business advisory, negotiating and representational services; provision of information, advice, assistance and consultancy services relating to all the aforesaid; information, advice and consultancy services relating to the sale of agricultural, horticultural and forestry products, trees, grains, seeds, flowers, fruits, vegetables, spices, drinks, non-alcoholic drinks and beverages; tea shops.) (526) : Registration of this mark shall give no right to the exclusive use of the words "AGRIBUSINESS", "SERVICES", "LIMITED" and the devices of a "GLOBE" and a "HUMAN HEAD" each separately and apart from the mark as a whole. (730) : DACHOGA HOLDINGS LIMITED A limited liability company duly incorporated under the laws of Kenya of P. O. Box 6480 - 00200, Nairobi, Kenya (740) : None

(210) : 144854 (220) : 16/02/2026 (300) : None (511) : 30(Tea; leaf tea; tea leaves; black tea; green tea; white tea; red tea; organic tea; herbal tea; fruit tea; spiced tea; tisanes; herbal tisanes; fruit tisanes; spiced tisanes; tea essences for foodstuffs, except etheric essences and essential oils; tea extracts; instant tea; tea mixtures; mixed plant tea; infusions; infusions for making beverages; tea bags; sachets; string and tag bags; envelope tea bags; pyramid infusers; iced tea; tea beverages; beverages having tea as a main ingredient; tea-flavoured beverages; tea products; cocoa; cocoa based beverages; cocoa beverages with milk; cocoa substitutes; beverages containing chocolate; chocolate beverages containing milk; drinking chocolate; spices; sugar; coffee; coffee based beverages; coffee beverages with milk; coffee extracts; coffee based preparations for making non-alcoholic coffee-based beverages; coffee syrup for food purposes; coffee concentrate (instant coffee); coffee extract for food flavouring purposes; chicory; chicory and chicory mixtures, all for use as substitutes for coffee; flavourings for beverages; herbal preparations for making beverages; herbal



beverages; ice beverages; ice cream drinks; prepared beverages containing the aforesaid goods; sachets containing the aforesaid goods for use with beverage preparation machines.) and 35(Marketingservices; advertising services; publicity services; business management services; business assistance; business administration; dissemination of advertising matter; promotional services; operation of sales and/or promotional incentive schemes; supervision and management of sales and/or promotional incentive schemes; franchising (business advisory services relating to-); commercial trading; consumer information services; import, export services; organisation of exhibitions for commercial or advertising purposes; demonstration of goods; presentation of goods on communication media for retail purposes; office machines and equipment rental; rental of vending machines; retail services connected with the sale of agricultural, horticultural and forestry products, trees, grains, seeds, flowers, fruits, vegetables, spices, drinks, non-alcoholic drinks and beverages; wholesale services connected with the sale of agricultural, horticultural and forestry products, trees, grains, seeds, flowers, fruits, vegetables, spices and beverages; the bringing together in a retail outlet, supermarket, café for the benefit of others of a variety of goods, namely agricultural, horticultural and forestry products, trees, grains, seeds, flowers, fruits, vegetables, spices, drinks, non-alcoholic drinks and beverages thereby to enable customers conveniently to view and purchase those goods; the bringing together in a wholesale outlet for the benefit of others of a variety of goods, namely agricultural, horticultural and forestry products, trees, grains, seeds, flowers, fruits, vegetables, spices, drinks, non-alcoholic drinks and beverages, thereby to enable customers conveniently to view and purchase those goods; the bringing together, for the benefit of others, of a variety of descriptions of, or of images of agricultural, horticultural and forestry products, trees, grains, seeds, flowers, fruits, vegetables, spices, drinks, non-alcoholic drinks and beverages in a catalogue, thereby to enable customers conveniently to view and to purchase those goods by mail order; the bringing together, for the benefit of others, of a variety of descriptions of or of images of agricultural, horticultural and forestry products, trees, grains, seeds, flowers, fruits, vegetables, spices, drinks, non- alcoholic drinks and beverages, on an Internet website, thereby to enable customers conveniently to view and to purchase those goods by means of telecommunications; business advisory, negotiating and representational services; provision of information, advice, assistance and consultancy services relating to all the aforesaid; information, advice and consultancy services relating to the sale of agricultural, horticultural and forestry products, trees, grains, seeds, flowers, fruits, vegetables, spices, drinks, non- alcoholic drinks and beverages; tea shops.) (526) : Registration of this mark shall give no right to the exclusive use of the word "LIMITED" and the devices of a "GLOBE" and a "HUMAN HEAD" each separately and apart from the mark as a whole. (730) : DACHOGA HOLDINGS LIMITED A limited liability company duly incorporated under the laws of Kenya of P. O. Box 6480 - 00200, Nairobi, Kenya (740) : None,

(210) : 144855 (220) : 16/02/2026 (300) : None (511) : 30(Tea; leaf tea; tea leaves; black tea; green tea; white tea; red tea; organic tea; herbal tea; fruit tea; spiced tea; tisanes; herbal tisanes; fruit tisanes; spiced tisanes; tea essences for foodstuffs, tea extracts; instant tea; tea mixtures; mixed plant tea; infusions; infusions for making beverages; tea bags; sachets; string and tag bags; envelope tea bags; pyramid infusers; iced tea; tea beverages; beverages having tea as a main ingredient; tea-flavoured beverages; tea products; flavourings for

*ChaDIT Local Tea Packers*

beverages; herbal preparations for making beverages; herbal beverages; ice beverages; ice cream drinks) and 35(Marketing services; advertising services; publicity services; business management services; business assistance; business administration; dissemination of advertising matter; promotional services; operation of sales and/or promotional incentive schemes; supervision and management of sales and/or promotional incentive schemes; franchising (business advisory services relating to-); commercial trading; consumer information services; import, export services; organisation of exhibitions for commercial or advertising purposes; demonstration of goods; presentation of goods on communication media for retail purposes; office machines and equipment rental; rental of vending machines; retail services connected with the sale of agricultural, horticultural and forestry products, trees, grains, seeds, flowers, fruits, vegetables, spices, drinks, non-alcoholic drinks and beverages; wholesale services connected with the sale of agricultural, horticultural and forestry products, trees, grains, seeds, flowers, fruits, vegetables, spices and beverages; the bringing together in a retail outlet, supermarket, café for the benefit of others of a variety of goods, namely agricultural, horticultural and forestry products, trees, grains, seeds, flowers, fruits, vegetables, spices, drinks, non-alcoholic drinks and beverages thereby to enable customers conveniently to view and purchase those goods; the bringing together in a wholesale outlet for the benefit of others of a variety of goods, namely agricultural, horticultural and forestry products, trees, grains, seeds, flowers, fruits, vegetables, spices, drinks, nonalcoholic drinks and beverages, thereby to enable customers conveniently to view and purchase those goods; the bringing together, for the benefit of others, of a variety of descriptions of, or of images of agricultural, horticultural and forestry products, trees, grains, seeds, flowers, fruits, vegetables, spices, drinks, non-alcoholic drinks and beverages in a catalogue, thereby to enable customers conveniently to view and to purchase those goods by mail order; the bringing together, for the benefit of others, of a variety of descriptions of, or of images of, agricultural, horticultural and forestry products, trees, grains, seeds, flowers, fruits, vegetables, spices, drinks, non-alcoholic drinks and beverages, on an Internet website, thereby to enable customers conveniently to view and to purchase those goods by means of telecommunications; business advisory, negotiating and representational services; provision of information, advice, assistance and consultancy services relating to all the aforesaid; information, advice and consultancy services relating to the sale of agricultural, horticultural and forestry products, trees, grains, seeds, flowers, fruits, vegetables, spices, drinks, non- alcoholic drinks and beverages; tea shops.) (526) : Registration of this mark shall give no right to the exclusive use of the words "TEA" and "PACKERS" each separately and apart from the mark as a whole. (730) : DACHOGA HOLDINGS LIMITED A limited liability company duly incorporated under the laws of Kenya of P. O. Box 6480 - 00200, Nairobi, Kenya (740) : None,

(210) : 144856 (220) : 16/02/2026 (300) : None (511) : 30(Tea; leaf tea; tea leaves; black tea; green tea; white tea; red tea; organic tea; herbal tea; fruit tea; spiced tea; tisanes; herbal tisanes; fruit tisanes; spiced tisanes; tea essences for foodstuffs, except etheric essences and essential oils; tea extracts; instant tea; tea mixtures; mixed plant tea; infusions; infusions for making beverages; tea bags; sachets; string and tag bags; envelope tea bags; pyramid infusers; iced tea; tea beverages; beverages having tea as a main ingredient; tea-flavoured beverages;

**NUTRI DELI**

---

tea products; cocoa; cocoa based beverages; cocoa beverages with milk; cocoa substitutes; beverages containing chocolate; chocolate beverages containing milk; drinking chocolate; spices; sugar; coffee; coffee based beverages; coffee beverages with milk; coffee extracts; coffee based preparations for making non- alcoholic coffee-based beverages; coffee syrup for food purposes; coffee concentrate (instant coffee); coffee extract for food flavouring purposes; chicory; chicory and chicory mixtures, all for use as substitutes for coffee; flavourings for beverages; herbal preparations for making beverages; herbal beverages; ice beverages; ice cream drinks; prepared beverages containing the aforesaid goods; sachets containing the aforesaid goods for use with beverage preparation machines.) and 35(Marketing services; advertising services; publicity services; business management services; business assistance; business administration; dissemination of advertising matter; promotional services; operation of sales and/or promotional incentive schemes; supervision and management of sales and/or promotional incentive schemes; franchising (business advisory services relating to-); commercial trading; consumer information services; import, export services; organisation of exhibitions for commercial or advertising purposes; demonstration of goods; presentation of goods on communication media for retail purposes; office machines and equipment rental; rental of vending machines; retail services connected with the sale of agricultural, horticultural and forestry products, trees, grains, seeds, flowers, fruits, vegetables, spices, drinks, non-alcoholic drinks and beverages; wholesale services connected with the sale of agricultural, horticultural and forestry products, trees, grains, seeds, flowers, fruits, vegetables, spices and beverages; the bringing together in a retail outlet, supermarket, café for the benefit of others of a variety of goods, namely agricultural, horticultural and forestry products, trees, grains, seeds, flowers, fruits, vegetables, spices, drinks, nonalcoholic drinks and beverages thereby to enable customers conveniently to view and purchase those goods; the bringing together in a wholesale outlet for the benefit of others of a variety of goods, namely agricultural, horticultural and forestry products, trees, grains, seeds, flowers, fruits, vegetables, spices, drinks, non-alcoholic drinks and beverages, thereby to enable customers conveniently to view and purchase those goods; the bringing together, for the benefit of others, of a variety of descriptions of, or of images of agricultural, horticultural and forestry products, trees, grains, seeds, flowers, fruits, vegetables, spices, drinks, non-alcoholic drinks and beverages in a catalogue, thereby to enable customers conveniently to view and to purchase those goods by mail order; the bringing together, for the benefit of others, of a variety of descriptions of, or of images of, agricultural, horticultural and forestry products, trees, grains, seeds, flowers, fruits, vegetables, spices, drinks, nonalcoholic drinks and beverages, on an Internet website, thereby to enable customers conveniently to view and to purchase those goods by means of telecommunications; business advisory, negotiating and representational services; provision of information, advice, assistance and consultancy services relating to all the aforesaid; information, advice and consultancy services relating to the sale of agricultural, horticultural and forestry products, trees, grains, seeds, flowers, fruits, vegetables, spices, drinks, non- alcoholic drinks and beverages; tea shops.) **(526)** : Registration of this mark shall give no right to the exclusive use of the word "DELI" separately and apart from the mark as a whole. **(730)** : DACHOGA HOLDINGS LIMITED A limited liability company duly incorporated under the laws of Kenya of P. O. Box 6480 - 00200, Nairobi, Kenya **(740)** : None,

---

**(210)** : 144857 **(220)** : 16/02/2026 **(300)** : None **(511)** : 30(Tea; leaf tea; tea leaves; black tea; green tea; white tea; red tea; organic tea; herbal tea; fruit tea; spiced tea; tisanes; herbal tisanes; fruit tisanes; spiced tisanes; tea essences for foodstuffs, tea extracts; instant tea; tea mixtures; mixed plant tea; infusions; infusions for making beverages; tea bags; sachets; string and tag bags; envelope tea bags; pyramid infusers; iced tea; tea beverages; beverages having tea as a main ingredient; tea-flavoured beverages; tea products; flavourings for beverages; herbal preparations for making beverages; herbal beverages; ice beverages; ice cream drinks) and 35(Marketing services; advertising services; publicity services; business management services; business assistance; business administration; dissemination of advertising matter; promotional services; operation of sales and/or promotional incentive schemes; supervision and management of sales and/or promotional incentive schemes; franchising (business advisory services relating to-); commercial trading; consumer information services; import, export services; organisation of exhibitions for commercial or advertising purposes; demonstration of goods; presentation of goods on communication media for retail purposes; office machines and equipment rental; rental of vending machines; retail services connected with the sale of agricultural, horticultural and forestry products, trees, grains, seeds, flowers, fruits, vegetables, spices, drinks, non-alcoholic drinks and beverages; wholesale services connected with the sale of agricultural, horticultural and forestry products, trees, grains, seeds, flowers, fruits, vegetables, spices and beverages; the bringing together in a retail outlet, supermarket, café for the benefit of others of a variety of goods, namely agricultural, horticultural and forestry products, trees, grains, seeds, flowers, fruits, vegetables, spices, drinks, non-alcoholic drinks and beverages thereby to enable customers conveniently to view and purchase those goods; the bringing together in a wholesale outlet for the benefit of others of a variety of goods, namely agricultural, horticultural and forestry products, trees, grains, seeds, flowers, fruits, vegetables, spices, drinks, nonalcoholic drinks and beverages, thereby to enable customers conveniently to view and purchase those goods; the bringing together, for the benefit of others, of a variety of descriptions of or of images of agricultural, horticultural and forestry products, trees, grains, seeds, flowers, fruits, vegetables, spices, drinks, non-alcoholic drinks and beverages in a catalogue, thereby to enable customers conveniently to view and to purchase those goods by mail order; the bringing together, for the benefit of others, of a variety of descriptions of or of images of agricultural, horticultural and forestry products, trees, grains, seeds, flowers, fruits, vegetables, spices, drinks, non-alcoholic drinks and beverages, on an Internet website, thereby to enable customers conveniently to view and to purchase those goods by means of telecommunications; business advisory, negotiating and representational services; provision of information, advice, assistance and consultancy services relating to all the aforesaid; information, advice and consultancy services relating to the sale of agricultural, horticultural and forestry products, trees, grains, seeds, flowers, fruits, vegetables, spices, drinks, non- alcoholic drinks and beverages; tea shops.) **(526)** : TEARegistration of this mark shall give no right to the exclusive use of the words "TEA", "VALUE", "ADD" and "SERVICE" each separately and apart from the mark as a whole. **(730)** : DACHOGA HOLDINGS LIMITED A limited liability company duly incorporated under the laws of Kenya of P. O. Box 6480 - 00200, Nairobi, Kenya **(740)** : None,

*ChaDIT Tea Value Add Service*

**(210)** : 144859 **(220)** : 17/02/2026 **(300)** : None **(511)** : 30(Flour and preparations made from cereals; bread, pastries and confectionary) **(526)** : PREMIUM Registration of this mark shall give no right to the exclusive use of the words "PREMIUM" , "QUALITY", "WHITE", "BREAD" and the device of a " CHEF HOLDING A LOAF BREAD" each separately and apart from the mark as a whole. **(730)** : LAYTON DISTRIBUTORS LTD of P. O. Box 2509 - 00610, Nairobi, Kenya **(740)** : None,



**(210)** : 144861 **(220)** : 17/02/2026 **(300)** : None **(511)** : 41(Betting Services) **(526)** : Registration of this mark shall give no right to the exclusive use of the words 'BET' and the acronym '.COM' each separately and apart from the mark as a whole. **(730)** : NEXTPLAY SOLUTIONS LIMITED of P. O. Box 60416 - 00200 Nairobi, Kenya **(740)** : None,



**(210)** : 144862 **(220)** : 17/02/2026 **(300)** : None **(511)** : 30(Rice) **(526)** : Registration of this mark shall give no right to the exclusive use of the device of 'BOWL OF RICE' separately and apart from the mark as a whole. 'SAWEE' is a coined word. **(730)** : BHAVIYA COMMODITIES LIMITED of P. O. Box 3528 - 80100, Mombasa, Kenya **(740)** : None,



**(210)** : 144863 **(220)** : 17/02/2026 **(300)** : None **(511)** : 9(Computers, laptops, tablets; computer software and applications; smartphones and wearable devices; electronic storage devices; scientific, laboratory, and optical instruments; audio/visual equipment.) and 42(Software design, development, licensing and maintenance; IT and cloud computing services; website design and maintenance; technology and engineering consultancy; scientific and industrial research; laboratory testing and analysis.) **(526)** : Registration of this mark shall give no right to the exclusive use of the acronym "MY", the letter "F", the words "GENESIS", "SEE" and "FUTURE" each separately and apart from the mark as a whole. **(730)** : NJERI MUCHUNU GLOBAL LIMITED of P. O. Box 8985 - 00200, City square, Nairobi, Kenya **(740)** : None,



**(210)** : 144864 **(220)** : 18/02/2026 **(300)** : None **(511)** : 9(Apparatus and instruments for scientific or research purposes, audiovisual and information technology equipment, as well as safety and life saving equipment.) and 36(Financial, monetary and banking services; insurance services; real estate services) **(526)** : PESA Registration of this mark shall give no right to the exclusive use of the word "PESA" separately and apart from the mark as a whole. The English translation of the Swahili word "PESA" is "Money". **(730)** : FAMILY BANK LIMITED of P. O. Box 74145 - 00200, Nairobi, Kenya **(740)** : Kimani And Muriithi Associates Advocates of P. O. Box 62225 - 00200, Nairobi, Kenya



## MILLENIALS HANGOUT

**(210)** : 144865 **(220)** : 18/02/2026 **(300)** : None **(511)** : 41(Education; providing of training; entertainment; sporting and cultural activities) **(526)** : None **(730)** : VIBE FORGE VENTURES LIMITED of P. O. Box 7062 -40100, Kisumu, Kenya **(740)** : Wachuka Musomba Advocates of P. O. Box 35691 - 00100, Nairobi, Kenya

**(210)** : 144866 **(220)** : 18/02/2026 **(300)** : None **(511)** : 4(Industrial oils and greases; lubricants; dust absorbing, wetting and binding compositions; fuels (including motor spirit) and illuminants; candles and wicks for lighting) **(526)** : ULTRA Registration of this mark shall give no right to the exclusive use of the words "ULTRA" and "DIAMOND" each separately and apart from the mark as a whole. **(730)** : DELSON TIRES & TUBES LTD of P. O. Box 39053 - 00623, Nairobi, Kenya **(740)** : None,



(210) : 144875 (220) : 18/02/2026 (300) : None (511) : 25(Mainly clothing, footwear and headwear for human beings.) (526) : APPARELRegistration of this mark shall give no right to the exclusive use of the words "APPAREL" and "LIMITED" each separately and apart from the mark as a whole. (730) : HERITAGE APPAREL LIMITED of P. O. Box 859 - 80109, Mtwapa, Kenya (740) : None,



(210) : 144876 (220) : 18/02/2026 (300) : None (511) : 30(Coffee, tea, cocoa and substitutes therefor; rice, pasta and noodles; tapioca and sago; flour and preparations made from cereals; bread, pastries and confectionery; chocolate; ice cream, sorbets and other edible ices; sugar, honey, treacle; yeast, baking powder; salt, seasonings, spices, preserved herbs; vinegar, sauces and other condiments; ice (frozen water.) (526) : None (730) : NITRA COMMODITIES EAST AFRICA LIMITED a Private Liability Company duly incorporated under the laws of Kenya of P. O. Box 85110 - 80100, Mombasa, Kenya (740) : None,

nitra

(210) : 144914 (220) : 20/02/2026 (300) : None (511) : 3(Cakes of toilet soap; soap; dentifrices; powder laundry detergents; liquid soap for laundry; laundry balls filled with laundry detergents, washing balls filled with laundry detergents; bath oil for cosmetic use; cleaning preparations; baby wipes impregnated with cleaning preparations; bleaching preparations and other substances for laundry use) and 16(Wrapping paper; packing paper, plastic film for wrapping; bottle wrappers of paper or cardboard; sheets of reclaimed cellulose for wrapping; viscose sheets for wrapping; paper bags for use in the sterilization of medical instruments; paper bags for use in the sterilisation of medical instruments; printed publications; toilet paper, hygienic paper, towels of paper; face towels of paper) (526) : None (730) : SUNDA ENTERPRISE LIMITED a company duly incorporated under the laws of Cayman Islands of Palm Grove Unit 4, 265 Smith Road, George Town, P.O. Box 52A Edgewater Way, #1653, Grand Cayman KY1-9006, Cayman Islands (740) : Krhoda & Macharia Advocates of P. O. Box 56745 - 00200, Nairobi, Kenya

MOSSE

(210) : 144915 (220) : 20/02/2026 (300) : None (511) : 5(Sanitary napkins; sanitary towels, sanitary napkins, sanitary pads; babies' nappies; babies' diaper-pants; menstruation tampons; sanitary knickers; diaper changing mats, disposable, for babies, nappy changing mats, disposable, for babies; swim diapers, reusable, for babies, swim nappies, reusable, for babies; wipes impregnated with disinfectants for hygiene purposes; tissues impregnated with pharmaceutical lotions) and 16(Wrapping paper; packing paper; plastic film for wrapping ; bottle wrappers of paper or cardboard; sheets of reclaimed cellulose for wrapping; viscose sheets for wrapping; paper bags for use in the sterilization of medical instruments; paper bags for use in the sterilisation of medical instruments; printed publications; toilet paper, hygienic paper; towels of paper, face towels of paper) (526) : None (730) : SUNMART TRADING FZCO of 5WA 219, 5WB 243, Second Floor, 5 West A, 5 West B, Dubai Airport Freezone, United Arab Emirates (740) : None,

MOMENT

(210) : 144916 (220) : 20/02/2026 (300) : None (511) : 3(Cakes of toilet soap; soap; dentifrices; powder laundry detergents; liquid soap for laundry; laundry balls filled with laundry detergents, washing balls filled with laundry detergents; bath oil for cosmetic use; cleaning preparations; baby wipes impregnated with cleaning preparations; bleaching preparations and other substances for laundry use) (526) : None (730) : SUNDA ENTERPRISE LIMITED a company duly incorporated under the laws of Cayman Islands of Palm Grove Unit 4, 265 Smith Road, George Town, P.O. Box 52A Edgewater Way, #1653, Grand Cayman KY1-9006, Cayman Islands (740) : Krhoda & Macharia Advocates of P. O. Box 56745 - 00200, Nairobi, Kenya



**(210) : 144917 (220) : 20/02/2026 (300) : None (511) : 3**(Cakes of toilet soap; soap; dentifrices; powder laundry detergents; liquid soap for laundry; laundry balls filled with laundry detergents, washing balls filled with laundry detergents; bath oil for cosmetic use; cleaning preparations; baby wipes impregnated with cleaning preparations; bleaching preparations and other substances for laundry use) **(526) : None (730) : SUNDA ENTERPRISE LIMITED** a company duly incorporated (under the laws of Cayman Islands of Palm Grove Unit 4, 265 Smith Road, George Town, P.O. Box 52A Edgewater Way, #1653, Grand Cayman KY1-9006, Cayman Islands **(740) : Krhoda & Macharia Advocates of P. O. Box 56745 - 00200, Nairobi, Kenya**



**(210) : 144918 (220) : 20/02/2026 (300) : None (511) : 3**(Cakes of toilet soap; soap; dentifrices; powder laundry detergents; liquid soap for laundry; laundry balls filled with laundry detergents, washing balls filled with laundry detergents; bath oil for cosmetic use; cleaning preparations; baby wipes impregnated with cleaning preparations; bleaching preparations and other substances for laundry use) **(526) : None (730) : SUNDA ENTERPRISE LIMITED** a company duly incorporated under the laws of Cayman Islands of Palm Grove Unit 4, 265 Smith Road, George Town, P.O. Box 52A Edgewater Way, #1653, Grand Cayman KY1-9006, Cayman Islands **(740) : Krhoda & Macharia Advocates of P. O. Box 56745 - 00200, Nairobi, Kenya**



**(210) : 144919 (220) : 20/02/2026 (300) : None (511) : 39**(Car hire services; arranging of car hire services) **(526) : HIRE**Registration of this mark shall give no right to the exclusive use of the words "CAR", "HIRE", "SERVICES" and the device of a "CAR" each separately and apart from the mark as a whole. **(730) : MARCEL AWORI** of P. O. Box 136 - 00606, Sarit Center, Nairobi, Kenya **(740) : None,**



**PROFLEET AFRICA**

**(210) : 144920 (220) : 20/02/2026 (300) : None (511) : 39**(Car hire services; arranging of car hire services) **(526) : Registration** of this mark shall give no right to the exclusive use of the word "AFRICA" separately and apart from the mark as a whole. **(730) : MARCEL AWORI** of P. O. Box 136 - 00606, Sarit Center, Nairobi, Kenya **(740) : None,**

**(210) : 144925 (220) : 23/02/2026 (300) : None (511) : 43**(Services for providing food and drink; temporary accommodation.) **(526) : MARA**Registration of this mark shall give no right to the exclusive use of the word "PALAZZO" and the geographical name "MARA" each separately and apart from the mark as a whole. The English translation of the Italian word "PALAZZO" is "A Large, Luxurious or Stately Building". **(730) : SANIDECO EAST AFRICA LTD** of P. O. Box 35337 - 00100, Nairobi, Kenya **(740) : None,**

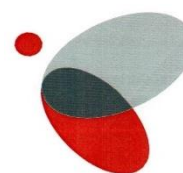

**PALAZZO MARA**

Retreat. Relax. Reconnect

**(210) : 144926 (220) : 23/02/2026 (300) : None (511) : 41**(Education; providing of training; entertainment services; betting and gambling, sporting services, music activities, mobile games and cultural activities) **(526) : None Avinox** is a coined word with no specific English meaning. **(730) : CHACHISHA LIMITED** of P. O. Box 18990 - 00500, Nairobi, Kenya **(740) : None,**



**(210)** : 144931 **(220)** : 23/02/2026 **(300)** : None **(511)** : 35(Business networking services; organization of business and professional networking events; business advisory and consultancy services; providing business information and support services to entrepreneurs and professionals; organization of exhibitions and events for commercial and professional purposes. Advertising; business management; business administration; office functions.), 41(Provision of education and training services; organization and conducting of workshops, seminars and conferences; leadership development training; mentorship programs; community capacity-building services; educational forums for personal and professional development; arranging and conducting networking events for educational purposes. Education; providing of training; entertainment; sporting and cultural activities.) and 45(Community organizing services; social development services; organizing community-based initiatives for social impact; personal and community support services. Legal services; security services for the protection of property and individuals; personal and social services rendered by others to meet the needs of individuals.) **(526)** : Registration of this mark shall give no right to the exclusive use of the words "CODE" and "ONE" each separately and apart from the mark as a whole. **(730)** : TALYSCO GROUP LIMITED of P. O. Box 28411 -00100, GPO, Nairobi, Kenya **(740)** : None,



**(210)** : 144949 **(220)** : 24/02/2026 **(300)** : None **(511)** : 41(Podcast; education; providing of training; entertainment; sporting and cultural activities.) **(526)** : RISING Registration of this mark shall give no right to the exclusive use of the word "RISING" and the letter "R" each separately and apart from the mark as a whole The mark is restricted to the colors "OLIVE GREEN", "ROYAL PURPLE" and "OFF WHITE". **(730)** : MWITA NAOMI BOKE of P. O. Box 523439 - 00200, City Square, Kenya **(740)** : None,



**(210)** : 144950 **(220)** : 24/02/2026 **(300)** : None **(511)** : 42(Scientific and technological services and research and design relating thereto; industrial analysis and research services; design and development of computer hardware and software.) **(526)** : A Registration of this mark shall give no right to the exclusive use of the letters "A", "I" and the device of "HUMAN HEAD" each separately and apart from the mark as a whole. "AMINATA" is a coined word with no specific meaning in English. **(730)** : GURASTREAM LTD of P. O. Box 57376 - 00200, Nairobi, Kenya **(740)** : None,



**(210)** : 144957 **(220)** : 24/02/2026 **(300)** : None **(511)** : 31(Flowers) **(526)** : None The English translation of the Swahili word "KIKWETU" is "Our Ways". **(730)** : KIKWETU FLOWERS of P. O. Box 132 - 10406, Kikwetu Flowers Ltd of Timau, Kenya **(740)** : None,



**(210)** : 144975 **(220)** : 24/02/2026 **(300)** : None **(511)** : 30(Tea, cocoa.) and 39(Transport; packaging and storage of goods) **(526)** : GREEN Registration of this mark shall give no right to the exclusive use of the words "GREEN", "CRATE" and "EXPORTS" each separately and apart from the mark as a whole. **(730)** : GREEN CRATE EXPORTS LIMITED of P. O. Box 61323 - 00200, Nairobi, Kenya **(740)** : None,



**(210)** : 144976 **(220)** : 24/02/2026 **(300)** : None **(511)** : 30(Tea, cocoa.) and 39(Transport; packaging and storage of goods) **(526)** : None **(730)** : GREEN CRATE EXPORTS LIMITED of P. O. Box 61323 - City Square, Kenya **(740)** : None,

**AURORA**

(210) : 144982 (220) : 24/02/2026 (300) : None (511) : 4(Liquefied petroleum gas) (526) : GASRegistration of this mark shall give no right to the exclusive use of the word "GAS" and the device of a "FLAME" each separately and apart from the mark as a whole. "ZAK" is a coined word with no meaning in English(730) : RIZAK ENERGY LPG LIMITED of P. O. Box 62 - 40506, Kebirigo, Kenya (740) : None,



(210) : 144997 (220) : 25/02/2026 (300) : None (511) : 43(Services for providing food and drink; temporary accomodation) (526) : Registration of this mark shall give no right to the exclusive use of the letter 'M' and the word 'MARA' each separately and apart from the mark as a whole. (730) : KUMSAI LIMITED of P. O. Box 18095 - 00500 Nairobi, Kenya (740) : None,



(210) : 144999 (220) : 25/02/2026 (300) : None (511) : 30(Flour and preparation made from cereals) (526) : MAIZERegistration of this mark shall give no right to the exclusive use of the words "MAIZE", "MEAL" and the devices of "MAIZE COMB", "WHEAT" and "GRAIN" each separately and apart from the mark as a whole. (730) : NORTHERN GRAND GRAIN MILLER LTD of P. O. Box 83 - 60300, Isiolo, Kenya (740) : None,



(210) : 145001 (220) : 25/02/2026 (300) : None (511) : 30(Flour and preparation made from cereals. ) (526) : PREMIUMRegistration of this mark shall give no right to the exclusive use of the "PREMIUM", "SOUR", "UJI", the devices of "MAIZE", "COB" and "WHEAT" each separately and apart from the mark as a whole. The English translation of the Kiswahili word "RAHA" is "Enjoyment/Being Happy". The English translation Kiswahili word "UJI" is "Porridge". (730) : JOY MILLER LIMITED of P. O. Box 1120 - 10300, Kerugoya, Kenya (740) : None,



(210) : 145005 (220) : 25/02/2026 (300) : None (511) : 5(Dietary Food Supplements) (526) : EARTHRegistration of this mark shall give no right to the exclusive use of the words "EARTH" and "WELLNESS" each separately and apart from the mark as a whole. (730) : VOBYL VENTURES LTD of P. O. Box 38958 - 00100 Nairobi, Nairobi, Kenya (740) : Jared Nchore Orare , Olande, Orare & Samba Advocates LLP of P. O. Box 102002 - 00101, Nairobi, Kenya



(210) : 145024 (220) : 25/02/2026 (300) : None (511) : 16(Paper and cardboard; printed matter, bookbinding material; photographs; stationery and office requisites, except furniture; adhesives for stationery or household purposes; drawing materials and materials for artists; paintbrushes; instructional and teaching materials; plastic sheets, films and bags for wrapping and packaging; printers' type, printing blocks.) and 36(Financial, monetary and banking services; insurance services; real estate services.) (526) : None The English translation of the Telugu word "KAVALI" is "Protection" or "Security". (730) : SD EAST AFRICA SHALOM DEVELOPMENT AND INFRASTRUCTURE LIMITED of P. O. Box 25598 - 00603, Nairobi, Kenya (740) : Madsen & Associates Advocates of P. O. Box 58543 - 00200, Nairobi, Kenya

**KAVALI**

(210) : 145025 (220) : 25/02/2026 (300) : None (511) : 36(Insurance; financial affairs; monetary affairs; real estate affairs) (526) : Registration of this mark shall give no right to the exclusive use of the letters "F", "M", the words "MONEY", "FREELANCE" and the device of a "WORLD GLOBE" each separately and apart from the mark as a whole. (730) : FINCAST COMPANY LIMITED of P. O. Box 13147 - 00200, Nairobi, Kenya (740) : None,



**(210)** : 145026 **(220)** : 25/02/2026 **(300)** : None **(511)** : 31(Animal feeds) **(526)** : ANIMAL",Registration of this mark shall give no right to the exclusive use of the words "ANIMAL", "FEEDS" and the device of a "BUFFALO" each separately and apart from the mark as a whole The English translation of the Luo word "JOWI" is "BUFFALO". **(730)** : RATEGO FLOUR LIMITED of P. O. Box 12 - 40601, Bondo, Kenya **(740)** : None,



**(210)** : 145031 **(220)** : 26/02/2026 **(300)** : None **(511)** : 33(Alcoholic beverages, except beers; alcoholic preparations for making beverages; in particular, wines, fortified wines; alcoholic cider, perry; spirits, liqueurs; alcoholic essence, alcoholic fruit extracts, bitters.) **(526)** :Registration of this mark shall give no right to the exclusive use of the words "LONDON", "DRY" and "GIN" each separately and apart from the mark as a whole. The English translation of the Swahili word "IMARA" is "Strong", "Firm" or "Stable", it signifies strength of character, determination and empowerment. **(730)** : SAVANNA BRANDS COMPANY LIMITED of P. O. Box 14208 - 00800, Kenya **(740)** : None,

**IMARA (LONDON DRY GIN)**

**(210)** : 145065 **(220)** : 27/02/2026 **(300)** : None **(511)** : 9(Scientific, nautical, surveying, photographic, cinematographic, optical, weighing, measuring, signalling, checking (supervision), life-saving and teaching apparatus and instruments; apparatus and instruments for conducting, switching, transforming, accumulating, regulating or controlling electricity; apparatus for recording, transmission or reproduction of sound or images; magnetic data carriers, recording discs; automatic vending machines and mechanisms for coin-operated apparatus; cash registers, calculating), 35(Advertising; business management; business administration; office functions.), 36(Insurance; financial affairs; monetary affairs; real estate affairs.) and 42(Scientific and technological services and research and design relating thereto; industrial analysis and research services; design and development of computer hardware and software) **(526)** : SEAMLESSRegistration of this mark shall give no right to the exclusive use of the words "SEAMLESS" and "TECHNOLOGIES" each separately and apart from the mark as a whole. **(730)** : THE SEAMLESS COMPANY LIMITED of 24 Bank Street, Cybercity Fifth Floor, Ebene Esplanade Ebene, Mauritius **(740)** : Mosoti & Company Advocates of P. O. Box 6256 - 00300, Nairobi, Kenya

**SEAMLESS TECHNOLOGIES**

**(210)** : 145076 **(220)** : 27/02/2026 **(300)** : None **(511)** : 42(Scientific and technological services and research and design relating thereto; industrial analysis and research services: design and development of computer hardware and software) **(526)** : None. **(730)** : ANTHONY KABURI KABIRIRI of P. O. Box 52434 - 00100, Nairobi, Kenya **(740)** : None,

  
**Florisynergy**

**(210)** : 145079 **(220)** : 02/03/2026 **(300)** : None **(511)** : 6(Metal building materials; Transportable buildings of metals ), 19(Building materials (non-metallic), 20(Furniture mirrors), 21(Household or kitchen utensils and containers) and 37(Building construction- Repair: installation services) **(526)** : Registration of this mark shall give no right to the exclusive use of the device of the "HUT" separately and apart from the mark as a whole. **(730)** : BOMEXA LIMITED of P. O. Box 2760 - 00100, Nairobi, Kenya **(740)** : None,



**(210)** : 145080 **(220)** : 02/03/2026 **(300)** : None **(511)** : 9(Cash registers, calculating machines, data processing equipment, computers; computer software;), 19(Building materials; (non-metallic); non-metallic rigid pipes for building; non-metallic transportable buildings; monuments non-metallic.), 20(Furniture, mirrors, picture frames; meerschaum and substitutes for all these materials or of plastics.), 21(Household or kitchen utensils and containers; combs; sponges; brushes; articles for cleaning purposes; steelwool; porcelain and earthenware not included in other classes.), 35(Advertising; business management; business administration; office functions ), 36(Financial affairs; monetary affairs; real estate affairs.) and 37( Building construction; repair; installation services.) **(526)**: ORegistration of this mark shall give no right to the exclusive use of the letters "O", "X" and the device of the "HUT" per se each separately and apart from the mark as a whole. **(730)** : BOMEXA LIMITED of P. O. Box 2760 - 00100, Nairobi, Kenya **(740)** : None,



**(210)** : 145081 **(220)** : 02/03/2026 **(300)** : None **(511)** : 35(Advertising; business management; business administration; office functions.), 39(Packaging and storage of Goods; Travel Arrangement) and 41(Entertainment; Sporting and Cultural Activities.) **(526)** : LIVINGRegistration of this mark shall give no right to the exclusive use of the words "LIVING", "LIFESTYLE", the hashtag symbol "#", the letters "I", "L" and "R" each separately and apart from the mark as a whole. **(730)** : BOMEXA LIMITED of P. O. Box 2760 - 00100, Nairobi, Kenya **(740)** : None,

Living The #ILRlifestyle

**(210)** : 145086 **(220)** : 02/03/2026 **(300)** : None **(511)** : 38(Providing telecommunication services via platforms and portals on the internet and other media; electronic and streaming of digital media contents for others via global and local computer networks.), 41(Events management services based on lifestyle platform that curates stylish, pet-friendly experience for dog lovers and their furry companions. Organising and bring the 254's pet community together through fun, safe and engaging events.) and 44(Medical services; Veterinary services; Hygienic and beauty care for animals; grooming and wellness workshops for pets.) **(526)** : PAWRegistration of this mark shall give no right to the exclusive use of the words "PAW", "EVENTS" and the device of the "PET FOOT PRINTS" each separately and apart from the mark as a whole. **(730)** : ZERO FOUR ZERO FOUR MEDIA AND EVENTS COMPANY LIMITED A limited liability company duly incorporated under the laws of Kenya of P. O. Box 4483 - 00100, Nairobi, Kenya **(740)** : None,

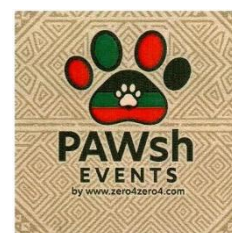

**(210)** : 145087 **(220)** : 02/03/2026 **(300)** : None **(511)** : 42(Scientific and technological services and research and design relating thereto; industrial analysis and research services; design and development of computer hardware and software) **(526)** : None **(730)** : BITWISE DIGITAL SOLUTIONS LIMITED of P. O. Box 10664 - 00200, Nairobi, Kenya **(740)** : None,

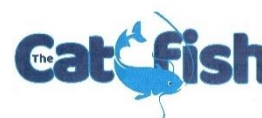

**(210)** : 145092 **(220)** : 02/03/2026 **(300)** : None **(511)** : 32(Mineral and aerated waters and other non-alcoholic beverages; Fruit beverages and fruit juices; Syrups and other preparations for making beverages; Beers.) **(526)** : ENERGYRegistration of this mark shall give no right to the exclusive use of the words "ENERGY", "DRINK", the letters "S", "T" and "W" each separately and apart from the mark as a whole. **(730)** : QORIYO ENTERPRISES LIMITED of P. O. Box 75974 - 00610, Eastleigh, Kenya **(740)** : None,



**(210)** : 145098 **(220)** : 02/03/2026 **(300)** : None **(511)** : 9(Scientific, research, and teaching apparatus and instruments; computer software; mobile applications; downloadable software applications for health management; electronic medical records (EMRs) software; digital health platforms; patient monitoring software; appointment scheduling software; recorded and downloadable media in the field of healthcare and medical training.), 41(Education; providing of training; medical training; professional development; workshops; seminars; continuing medical education (CME); health education; provision of online educational courses in the field of maternal, newborn and child health; publication of educational material. Education; providing of training; medical training; professional development; workshops; seminars; continuing medical education (CME); health education; provision of online educational courses in the field of maternal, newborn and child health; publication of educational material.), 42(Scientific and technological services and research; medical research; clinical trials; development of digital health solutions; data analytics and reporting services in the field of healthcare; design and development of computer software; software as a service (SaaS) in the field of healthcare. ) and 44(Medical services; healthcare; clinical and preventive healthcare services; maternal health care; child health care; obstetrics and gynecology services; pediatrics and neonatology services; reproductive health services; telemedicine services; remote medical consultation; wellness programs; mental health services ; advisory and consultancy in the field of healthcare.) **(526)** : MRegistration of this mark shall give no right to the exclusive use of the letters "M", "C", "I", the word "CONNECT" and the plus symbol "+" each separately and apart from the mark as a whole. **(730)** : M-MCH CONNECT LIMITED of P. O. Box 19305 - 00202, Nairobi, Kenya **(740)** : ONC Law Partners of P. O. Box 37592 -00100, Nairobi, Kenya



**(210)** : 145115 **(220)** : 04/03/2026 **(300)** : None **(511)** : 32(Beers; mineral and aerated waters and other non-alcoholic beverages; fruit beverages and fruit juices; syrups and other preparations for making beverages) **(526)** : GOILRegistration of this mark shall give no right to the exclusive use of the word "GOLD" separately and apart from the mark as a whole "MANSA" is a coined word with no specific meaning in English. **(730)** : MANSA GOLD LIMITED of P. O. Box 4949 - 00100, Thika, Kenya **(740)** : None,



**(210)** : 145127 **(220)** : 04/03/2026 **(300)** : None **(511)** : 35(Advertising; business management; business administration; office functions.), 36(Financial, monetary and banking services; insurance services; real estate services.) and 42( Scientific and technological services and research and design relating thereto; industrial analysis and research services; design and development of computer hardware and software.) **(526)** : Registration of this mark shall give no right to the exclusive use of the words "EXPERIENCE THE ULTIMATE" each separately and apart from the mark as a whole. **(730)** : VICTORIA COMMERCIAL BANK of P. O. Box 41114 - 00100, Kenya **(740)** : None,



**(210)** : 145128 **(220)** : 04/03/2026 **(300)** : None **(511)** : 35(Advertising; business management; business administration; office functions.), 36(Financial, monetary and banking services; insurance services; real estate services) and 42(Scientific and technological services and research and design relating thereto; industrial analysis and research services; design and development of computer hardware and software.) **(526)** : EXPERIENCERegistration of this mark shall give no right to the exclusive use of the words "EXPERIENCE THE ULTIMATE" each separately and apart from the mark as a whole. **(730)** : VICTORIA COMMERCIAL BANK of P. O. Box 41114 - 00100, Kenya **(740)** : None,



(210) : 145135 (220) : 05/03/2026 (300) : None (511) : 36(Insurance; financial affairs; monetary affairs; real estate affairs) and 38(Telecommunications) (526) : PAYRegistration of this mark shall give no right to the exclusive use of the word "PAY" separately and apart from the mark as a whole. The English translation of the Swahili word "AMBIA" is "Tell", "Say" or "Speak To". (730) : ELIGE COMMUNICATIONS LTD of P. O. Box 66268 -00800, Kenya (740) : None,



(210) : 145136 (220) : 05/03/2026 (300) : None (511) : 9(Liquid crystal display (LCD)) (526) : andRegistration of this mark shall give no right to the exclusive use of the word "ORDINARY" and the device of a "PHONE" separately and apart from the mark as a whole "MEETOO" is a coined word. (730) : WEALTHGATE PROPERTY (K) LIMITED of P. O. Box 71358 - 00610, Eastleigh, Kenya (740) : None,



(210) : 145155 (220) : 06/03/2026 (300) : None (511) : 41(Education; providing of training; entertainment services; betting and gambling, sporting services, music activities, mobile games and cultural activities) (526) : BETSRegistration of this mark shall give no right to the exclusive use of the word "BETS" separately and apart from the mark as a whole. (730) : JASIRI BET LIMITED JASBETS of P. O. Box 64671 - 00620, Nairobi, Kenya (740) : None,



(210) : 145161 (220) : 06/03/2026 (300) : None (511) : 24(Bath gloves) (526) : BLACKKRegistration of this mark shall give no right to the exclusive use of the word "BLACK", the numerals "4" and "5" each separately and apart from the mark as a whole. (730) : GOOD SPRAYING PRACTICE SCIENCE of P. O. Box 64311 - 00620, Mobil Plaza, Kenya (740) : None,

**BLACKGOLD-45**

(210) : 145163 (220) : 06/03/2026 (300) : None (511) : 8(Knapsack sprayer) and 35(Retail services of knapsack and sprayer) (526) : KNAPSACKRegistration of this mark shall give no right to the exclusive use of the words "KNAPSACK", "SPRAYER", the numerals "1" and "5" each separately and apart from the mark as a whole. (730) : GOOD SPRAYING PRACTICE SCIENCE of P. O. Box 64311 - 00620, Mobil Plaza, Kenya (740) : None,



(210) : 145164 (220) : 06/03/2026 (300) : None (511) : 12(Vehicles; apparatus for locomotion by land, air or water.), 16(Paper and cardboard; printed matter; bookbinding material; photographs; stationery and office requisites, except furniture; adhesives for stationery or household purposes; drawing materials and materials for artists; paintbrushes; instructional and teaching materials; plastic sheets, films and bags for wrapping and packaging; printers' type, printing blocks.), 25(Clothing, footwear, headwear.), 28(Games, toys and playthings; video game apparatus; gymnastic and sporting articles; decorations for Christmas trees.), 35(Advertising; business management; business administration; office functions.), 38(Telecommunications.), 40(Treatment of materials. ) and 41(Education; providing of training; entertainment; sporting and cultural activities.) (526) : FUNRegistration of this mark shall give no right to the exclusive use of the words "FUN", "CHALLENGE", the numeral "4" and the device of a "VEHICLE" each separately and apart from the mark as a whole. (730) : MUD4FUN 4X4 CHALLENGE LIMITED of P. O. Box 552683 - 00200, Nairobi, Kenya (740) : S.E. Gitau & CO. Advocates of P. O. Box 38746 - 00623, Nairobi, Kenya



(210) : 145165 (220) : 06/03/2026 (300) : None (511) : 4(Lpg), 6(Lpg gas cylinder) and 39(Transport, packaging & storage) (526) : None (730) : THERMEX GAS COMPANY LTD of P. O. Box 79007, Village Market, Kenya (740) : None,

**ROVA**

**(210)** : 145169 **(220)** : 09/03/2026 **(300)** : None **(511)** : 42(Website) **(526)** : Registration of this mark shall give no right to the exclusive use of the word 'BET', the letters 'M' and 'B' each separately and apart from the mark as a whole. **(730)** : SHEM KIPRONO of P. O. Box 46513 - 00100 Nairobi, Kenya **(740)** : None,



**(210)** : 145170 **(220)** : 09/03/2026 **(300)** : None **(511)** : 41(Betting Services) **(526)** : Registration of this mark shall give no right to the exclusive use of the word 'BET', the letters 'M' and 'B' each separately and apart from the mark as a whole. **(730)** : SHEM KIPRONO of P. O. Box 46513 - 00100 Nairobi, Kenya **(740)** : None,



**(210)** : 145171 **(220)** : 09/03/2026 **(300)** : None **(511)** : 12(Shock absorbers) **(526)** : Registration of this mark shall give no right to the exclusive use of the word 'SHOCKABSORBER' separately and apart from the mark as a whole. **(730)** : TROJESSE TRADERS LIMITED of P. O. Box 74474 - 00200, Nairobi, Kenya **(740)** : None,



**(210)** : 145172 **(220)** : 09/03/2026 **(300)** : None **(511)** : 41(Betting services) **(526)** : Registration of this mark shall give no right to the exclusive use of the word 'BET' separately and apart from the mark as a whole. **(730)** : VYNIX SAHARA LTD of P. O. Box 820 - 00902, Kikuyu, Kenya **(740)** : None,



**(210)** : 145187 **(220)** : 10/03/2026 **(300)** : None **(511)** : 11(Scientific, nautical, surveying, photographic, cinematographic, optical, weighing, measuring, signaling, checking (supervision), life-saving and teaching apparatus and instruments; apparatus and instruments for conducting, switching, transforming, accumulating, regulating or controlling electricity; apparatus for recording, transmission or reproduction of sound or images; magnetic data carriers, recording discs; compact discs, DVDs and other digital recording media; mechanisms for coin - operated apparatus; cash registers, calculating machines, data processing equipment, computers; computer software; fire-extinguishing apparatus) and 36(Insurance; financial affairs; monetary affairs; real estate affairs) **(526)** : None The English translation of the Swahili word "ASANTE" is "Thank You" that is used to express gratitude. **(730)** : INTERACTIVE MEDIA SERVICES LTD of P. O. Box 212105 - 00100, Nairobi, Kenya **(740)** : None,



**(210)** : 145195 **(220)** : 09/03/2026 **(300)** : None **(511)** : 9(Scientific, research, navigation, surveying, computers and computer peripheral devices.), 36(Financial, monetary and banking services; insurance services; real estate), 37(Construction services: installation and repair services), 42(Scientific and technological services and research and design relating thereto; industrial analysis. industrial research and industrial design services: quality control and authentication services; design and development of computer hardware and software.) and 44(Medical services: veterinary services; hygienic and beauty care for human beings or animals: agriculture, aquaculture, horticulture and forestry services.) **(526)** : None **(730)** : CCB CORRIDORS LIMITED of P. O. Box 293, Village Market, Nairobi, Kenya **(740)** : None,



**(210)** : 145196 **(220)** : 09/03/2026 **(300)** : None **(511)** : 31(Raw and unprocessed agricultural, aquacultural, horticultural and forestry products; raw and unprocessed grains and seeds; fresh fruits and vegetables, fresh herbs, natural plants and flowers; bulbs, seedlings and seeds for planting; live animals; foodstuffs and beverages for animals; malt.), 36(Financial, monetary and banking services



. insurance services: real estate services.), 37(Construction services; installation and repair services.), 42(Scientific and technological services and research and design relating thereto, industrial analysis, industrial research and industrial design services; quality control and authentication services; design and development of computer hardware and software.) and 44(Medical services: veterinary services : hygienic and beauty care for human beings or animals: agriculture, aquaculture, horticulture and forestry services.) **(526)** : Registration of this mark shall give no right to the exclusive use of the device of "LEAVES" per se separately and apart from the mark as a whole. **(730)** : CCB CORRIDORS LIMITED of P. O. Box 293, Village Market, Nairobi, Kenya **(740)** : None,

**(210)** : 145197 **(220)** : 09/03/2026 **(300)** : None **(511)** : 31(Raw and unprocessed agricultural, aquacultural, horticultural and forestry products; raw and unprocessed grains and seeds. fresh fruits and vegetables, fresh herbs; natural plants and flowers; bulbs, seedlings and seeds for planting: live animals: foodstuffs and beverages for animals; malt.), 36(Financial, monetary and banking services; insurance services; real estate), 37(Construction services: installation and repair services.), 42(Scientific and technological services and research and design relating thereto: industrial analysis, industrial research and industrial design services; quality control and authentication services; design and development of computer hardware and software.) and 44(Medical services; veterinary services, hygienic and beauty care for human beings or animals; agriculture, aquaculture, horticulture and forestry services.) **(526)** : Registration of this mark shall give no right to the exclusive use of the word "MITI" separately and apart from the mark as a whole. The English translation of the Swahili word "SISI NA MITI" is "Us And Trees". **(730)** : CCB CORRIDORS LIMITED of P. O. Box 293, Village Market, Nairobi, Kenya **(740)** : None,

## SISI NA MITI

**(210)** : 145198 **(220)** : 09/03/2026 **(300)** : None **(511)** : 9(Scientific, research, navigation, surveying, computers and computer peripheral devices.), 36(Financial. monetary and banking services; insurance services, real estate.), 37(Construction services; installation and repair services.), 42(Scientific and technological services and research and design relating thereto: industrial analysis, industrial research and industrial design services, quality control and authentication services; design and development of computer hardware and software.) and 44(Medical services; veterinary services; hygienic and beauty care for human beings or animals: agriculture, aquaculture, horticulture and forestry services.) **(526)** : Registration of this mark shall give no right to the exclusive use of the word "NATURE" separately and apart from the mark as a whole. **(730)** : CCB CORRIDORS LIMITED of P. O. Box 293, Village Market, Nairobi, Kenya **(740)** : None,

## VERITY NATURE

**(210)** : 145218 **(220)** : 10/03/2026 **(300)** : None **(511)** : 16(Printed matter), 35(Advertising), 41(Education) and 45(Promoting the interests of international real estate and non-profit companies in the fields of politics, legislation and regulation.) **(526)** : KAZIRegistration of this mark shall give no right to the exclusive use of the words "KAZI", "PAMOJA", the letters "A", "D" and "U" per se each separately and apart from the mark as a whole. The English translation of the Swahili phrase "KAZI NI KAZI MBELE PAMOJA" is "Work Is Work Forward Together". **(730)** : KELVIN KITIKA of P. O. Box 22880 - 00505, Nairobi, Kenya **(740)** : None,



(210) : 145257 (220) : 12/03/2026 (300) : None (511) : 9(Apparatus and instruments for scientific or research purposes, audiovisual and information technology equipment, as well as safety and life-saving equipment.), 11(Environmental control apparatus and installations for the purposes of lighting, cooking, cooling and sanitizing), 38(Telecommunications services.) and 42(Scientific and technological services and research and design relating thereto; industrial analysis, industrial research and industrial design services; quality control and authentication services; desi and development of computer hardware and software) (526) : Registration of this mark shall give no right to the exclusive use of the words "IGNITE", "ENERGY", "ACCESS" and "SCALE" each separately and apart from the mark as a whole. (730) : IGNITE ACCESS (KE) LIMITED of Purshottam Place 7th Floor, Westlands Road., Kenya (740) : None,



(210) : 145292 (220) : 12/03/2026 (300) : None (511) : 35(Retail minimart services featuring a wide variety of consumer goods) (526) : Registration of this mark shall give no right to the exclusive use of the word "MART" separately and apart from the mark as a whole. (730) : VEEW BROTHERS LIMITED of P. O. Box 10027 - 00100, 3rd Floor Top Plaza, Kindaruma Road, Nairobi, Kenya (740) : Omanga Law Advocates of P. O. Box 6266 - 00300, Nairobi, Kenya



## 9.2 Corrigenda

111) Mark number: 4326

(540) Trade Mark:



(511) Class: 16

(442) Date of advertisement: 31/12/2025

(580) Corrections

Classification of goods was erroneously omitted and should correctly appear as below.

43 (Magazines and newspapers, being printed publications.)

(111) Mark number: 134831

(540) Trade Mark:

**ORCHARD BLISS GOLD HONEY**

(511) Classes: **30 and 32**

(442) Date of advertisement: **31/12/2025**

(581) Corrections

Goods under Class 32 were erroneously omitted and should correctly appear as below:

32 (Beers; mineral and aerated water, and other non-alcoholic beverages; fruit beverages and fruit juices; syrups and other preparations for making beverages.)

### 9.3 Licence

(111) Mark number: 790391

(540) Mark: MÖVENPICK. (and logo)

(511) Classes: 29, 30, 42, 43 and 44

(730) Proprietor: Mövenpick Holding AG of Oberneuhofstrasse 12 CH-6340 Baar, Switzerland

(791) Licensee: MP Invest AG of Oberneuhofstrasse 12, 6340 Baar, Switzerland

(740) Address for correspondence: Ndungu Njoroge & Kwach Advocates of P. O. Box 41546 - 00100, Nairobi, Kenya.

.....

(111) Mark number: 865120

(540) Mark: MÖVENPICK

(511) Classes: 29, 30, 31, 32, 33, 35, 39, 41, 42 and 43

(730) Proprietor: Mövenpick Holding AG of Oberneuhofstrasse 12 CH-6340 Baar, Switzerland

(791) Licensee: MP Invest AG of Oberneuhofstrasse 12, 6340 Baar, Switzerland

(740) Address for correspondence: Ndungu Njoroge & Kwach Advocates of P. O. Box 41546 - 00100, Nairobi, Kenya.

.....

(111) Mark number: 57457

(540) Mark: MOVENPICK (and logo)

(511) Class: 43

(730) Proprietor: Movenpick Holding AG of Oberneuhofstrasse 12, 6340 Baar, Switzerland

(791) Licensee: MP Invest AG of Oberneuhofstrasse 12, 6340 Baar, Switzerland

(740) Address for correspondence: Ndungu Njoroge & Kwach Advocates of P. O. Box 41546 - 00100, Nairobi, Kenya.

.....

(111) Mark number: 94258

(540) Mark: (Logo only)

(511) Class: 33

(730) Proprietor: CHIVAS HOLDINGS {IP} LIMITED of 111-113 Renfrew Road, Paisley, Renfrewshire Pa3 4dy, Scotland, United Kingdom

(791) Licensee: Chivas Brothers Limited of 111- 113 Renfrew Road, Paisley PA3 4DY, Scotland, United Kingdom

(740) Address for correspondence: Ndungu Njoroge & Kwach Advocates of P. O. Box 41546 - 00100, Nairobi, Kenya.

.....

(111) Mark number: 108686

(540) Mark: MOVENPICK (and logo)

(511) Class: 36

(730) Proprietor: Mövenpick Holding AG of Oberneuhofstrasse 12, 6340 Baar, Switzerland

(791) Licensee: MP Invest AG of Oberneuhofstrasse 12, 6340 Baar, Switzerland

(740) Address for correspondence: Ndungu Njoroge & Kwach Advocates of P. O. Box 41546 - 00100, Nairobi, Kenya.

.....

#### 9.4 Withdrawal

118533	02/08/2021	ACTILICE	5	WALLACE PHARMACEUTICALS PVT LIMITED
143649	04/12/2025	KENYA THE ORIGIN OF WONDER	35	MINISTRY OF TOURISM AND WILDLIFE
143650	04/12/2025	ORIGIN OF WONDER	35	MINISTRY OF TOURISM AND WILDLIFE
143968	19/12/2025	R REMBO (and logo)	21	HUAHUI INTERNATIONAL GROUP COMPANY LIMITED

#### 9.5 Abandonment

128398	12/06/2023	NEBIUM	5	MSN LABORATORIES PRIVATE LIMITED
132335	19/02/2024	EMOFOZ	5	Forza Life Sciences Limited, a Limited Liability Company duly incorporated under the laws of Kenya.
134353	04/07/2024	WEZABET (and logo)	41	MORRIS MACHARIA MBUTHI

#### 9.6 Alteration of Goods

(111) Mark number: 82945

(730) Proprietor: TILISI DEVELOPMENTS PLC. of P. O. Box 39542 - 00623, Nairobi, Kenya

(511) Classes: 19, 36 and 37

(750) Address for service: Muriu, Mungai & Company Advocates LLP of P. O. Box 75362 - 00200, Nairobi, Kenya

(580) The list of goods and services is amended so that henceforth it appears as shown here under: 19 (Building materials (non-metallic); non metallic rigid pipes for building; asphalt, pitch and bitumen; non metallic transportable buildings; monuments, not of metal.) 36 (Financial, monetary and banking services; insurance services; real estate.), and 37 (Building construction; repair; installation services.)

.....

(111) Mark number: 128500

(730) Proprietor: MOHAMED ASIF LATIF of P. O. Box 38089 - 0623, Kenya

(511) Classes: 9, 16, 37 and 42

(750) Address for service:

(580) The list of goods and services is amended so that henceforth it appears as shown here under: 9 (Electronics, control systems.), 16 (Letterheads, Stationery, Complimentary Slips, Receipts, Payment vouchers.), 37 (Installation.) and 42 (Technology services.)

.....

(111) Mark number: 130117

(730) Proprietor: BEVALINE KHAYI WEKESA of P. O. Box 31519 - 00100, Nairobi, Kenya

(511) Classes: 1, 6, 9 and 19

(750) Address for service:

(580) The list of goods and services is amended so that henceforth it appears as shown here under: 1 (Chemicals used in industries, adhesives used in industries.), and 6 (common metals and their alloys; metal building materials of metal for railway tracks, non- electric cables and wires of common metal; ironmongery, small items of metal hardware; pipes and tubes of metal; safes; goods of common metal.), 9 (Scientific research navigation, surveying, photographic, cinematographic, audiovisuals, optical, weighing, measuring, signaling, detecting, testing, inspecting, life saving and teaching apparatus and instruments, apparatus and instruments for conducting switching, transforming, accumulating, regulating or controlling distribution or use of electricity, solars & batteries.) and 19 (Materials, not of metal, for building and construction; rigid

pipes, not of metal, for building; asphalt, pitch, tar and bitumen; transportable buildings, not of metal; monuments, not of metal.)

.....  
(111) Mark number: 132198

(730) Proprietor: BIDCO AFRICA LIMITED of P. O. Box 239 - 01000, Thika, Kenya

(511) Classes: 3 and 5

(750) Address for service:

(580) The list of goods and services is amended so that henceforth it appears as shown here under: 3 (Baby wipes impregnated with cleaning preparations, Non-medicated cosmetics and toiletry preparations; Essential oils / ethereal oils; lotions for cosmetic purposes; oils for cosmetic purposes; petroleum jelly for cosmetic purposes; Soap.) and 5 (Babies' diaper-pants / babies' nappy-pants, babies' diapers / babies' nappies, swim diapers, disposable, for babies/ swim nappies, disposable, for babies, swim diapers, reusable, for babies / swim nappies, reusable, for babies, Sanitary preparations for medical purposes; antibacterial soap; disinfectant soap; disinfectants for hygiene purposes; glycerine for medical purposes; lotions for pharmaceutical purposes; medicated soap; medicinal oils; ointments for pharmaceutical purposes; petroleum jelly for medical purposes; pharmaceutical preparations for skin care.)

.....  
**9.7 Alteration**

(111) Mark number: 17608

(730) Proprietor: GRAY LINE CORPORATION of P.O. Box 18267, Denver, Colorado 80218-0267, United States of America

(511) Class: 16

(750) Address for service: Perpetua N Law Advocatess T/A Von Seidels Kenya of P. O. Box 785 - 00618, Nairobi, Kenya.

(580) The mark is amended so that henceforth it appears as shown here under:



.....  
(111) Mark number: 55253

(730) Proprietor: PROPACK (KENYA) LIMITED of P. O. Box 48185, Nairobi, Kenya

(511) Class: 30

(750) Address for service: MW & Company Advocates LLP of P. O. Box 44468 - 00100, Nairobi, Kenya

(580) The mark is amended so that henceforth it appears as shown here under:

Registration of this mark shall give no right to the exclusive use of the device of the "GLOBE" separately and apart from the mark as a whole.



.....  
(111) Mark number: 137909

(730) Proprietor: KENSALT LIMITED of P.O. Box 50315 - 00100, Nairobi, Kenya

(511) Class: 29

(750) Address for service:

(580) The mark is amended so that henceforth it appears as shown here under:

Registration of this mark shall give no right to the exclusive use of the words 'SOLAI', 'HIGHLANDS', 'SHAKE', 'YOGHURT', 'BANANA' and the device of the 'BANANAS' each separately and apart from the mark as a whole



.....

(111) Mark number: 137910

(730) Proprietor: KENSALT LIMITED of P. O. Box 50315 - 00100, Nairobi, Kenya

(511) Class: 29

(750) Address for service:

(580) The mark is amended so that henceforth it appears as shown here under:

Registration of this mark shall give no right to the exclusive use of the words 'SOLAI', 'YOGHURT', 'HIGHLANDS', 'DRINKS', 'CHOCOLATE' and the device of 'CHOCOLATE' each separately and apart from the mark as a whole.



.....

(111) Mark number: 137912

(730) Proprietor: KENSALT LIMITED of P. O. Box 50315 - 00100, Nairobi, Kenya

(511) Class: 29

(750) Address for service:

(580) The mark is amended so that henceforth it appears as shown here under:

Registration of this mark shall give no right to the exclusive use of the words "SOLAI", "YOGHURT", 'SHAKE', "HIGHLANDS" and "VANILLA" each separately and apart from the mark as a whole



.....

(111) Mark number: 137964

(730) Proprietor: KENSALT LIMITED of P. O. Box 50315 - 00100, Nairobi, Kenya

(511) Class: 29

(750) Address for service:

(580) The mark is amended so that henceforth it appears as shown here under:

Registration of this mark shall give no right to the exclusive use of the words 'SOLAI', 'HIGHLANDS', 'YOGHURT', 'DRINK', 'SHAKE', 'FRUITS' and the devices of 'FRUITS' each separately and apart from the mark as a whole.

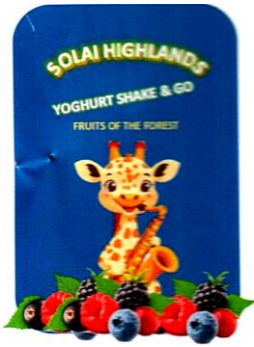

.....  
(111) Mark number: 137966

(730) Proprietor: KENSALT LIMITED of P. O. Box 50315 - 00100, Nairobi, Kenya

(511) Class: 29

(750) Address for service:

(580) The mark is amended so that henceforth it appears as shown here under:

Registration of this mark shall give no right to the exclusive use of the words "SOLAI", "HIGHLANDS", "YOGHURT", "DRINK" and "STRAWBERRY" and the devices of "FRUITS" each separately and apart from the mark as a whole.

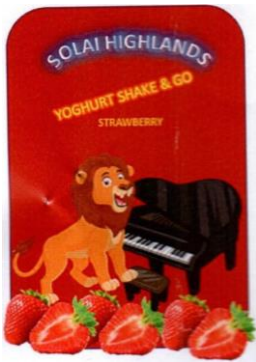

.....  
**9.8 Removal**

Section 23 of the Trade Marks Act provides that registration of a trade mark in Kenya shall expire after a period of **ten (10) years**. The Act also provides that the proprietor of a registered trade mark may make an application for renewal of the trade mark upon completion of the prescribed Form TM 10 and payment of the prescribed renewal fee.

Rule 65 of the Trade Mark Rules provides that where no application for renewal of a registered trade mark is received upon expiry of the ten year period, the Registrar of Trade Marks shall notify the proprietor of this fact. Where no application for renewal of the registered trade mark is received within a period of **sixty (60) days** from the date of the notice for renewal by the Registrar, rule 67 of the Trade Mark Rules requires the Registrar of Trade Marks to publish this fact.

**In accordance with the above provisions, the Registrar of Trade Marks hereby notifies the public that the proprietors of the trade marks indicated below were duly notified and that they did not file applications for renewal of their respective trade marks.**

In accordance with the provisions of rules 67 and 68 of the Trade Mark Rules, the public is hereby notified as follows:

Where the proprietor of a registered trade mark makes an application for renewal of a mark that has been published herein and pays the renewal fee together with the additional prescribed late renewal fee **within thirty (30) days** from the date of this publication, the trade mark shall be renewed and shall not be removed from the Register of Trade Marks;

Where no application for renewal of a trade mark published herein is received **within thirty (30) days** from the date of this publication, the trade mark shall be forthwith removed from the Register of Trade Marks; and

Once the trade mark is removed from the Register of Trade Marks, the proprietor may thereafter make an

application for renewal of the mark upon payment of the prescribed renewal fee together with the additional prescribed restoration fee. The trade mark shall then be restored to the Register of Trade Marks upon the Registrar of Trade Marks being satisfied that it is just to do so and upon imposing such conditions as the Registrar may deem fit.

33097	29/05/1985	AQUA-PLUS	3	Glaxo Group Limited	May 29, 2016
46478	03/10/1997	KEROL	5	Aventis CropScience UK Limited	October 3, 2007
46623	11/11/1997	PLUS (and logo)	3	INTERNATIONAL FOODSTUFFS CO	November 11, 2004
47278	15/04/1998	20 KING SIZE FILTER Kamaran (and logo)	34	NATIONAL TOBACCO & MATCHES CO.,	April 15, 2018
50981	11/12/2000	bp (and logo)	11	BP AMOCO P.I.C, a corporation organised under the laws of England and Wales. Manufacturers and Merchants	December 11, 2010
61033	23/04/2007	PIOZER Pioglitazone (and logo)	5	HILTON PHARMA (PRIVATE) LIMITED	April 23, 2017
61034	23/04/2007	GEVOLOX (and logo)	5	HILTON PHARMA (PRIVATE) LIMITED	April 23, 2017
61036	23/04/2007	LEOZIN (and logo)	5	HILTON PHARMA (PRIVATE) LIMITED	April 23, 2017
61037	23/04/2007	NEOGAB (Gabapentin) (and logo)	5	HILTON PHARMA (PRIVATE) LIMITED	April 23, 2017
61038	23/04/2007	CEFIM (Cefixime) (and logo)	5	HILTON PHARMA (PRIVATE) LIMITED	April 23, 2017
61039	23/04/2007	FEROSOFT-FA (and logo)	5	HILTON PHARMA (PRIVATE) LIMITED	April 23, 2017
61040	23/04/2007	RONEX (Cetirizine) (and logo)	5	HILTON PHARMA (PRIVATE) LIMITED	April 23, 2017
63095	22/04/2008	HTC SMART MOBILITY (and logo)	9	HTC CORPORATION	April 22, 2018
63103	06/11/2007	2 ON (and logo)	9	SAMSUNG ELECTRONICS CO., LTD (A Korean Corporation)	November 6, 2017
63104	23/04/2008	MARBLE JUNIOUR SAVINGS ACCOUNT (and logo)	36	IMPERIAL BANK LIMITED	April 23, 2018
63106	23/04/2008	CRYSTAL SAVINGS ACCOUNT (and logo)	36	IMPERIAL BANK LIMITED	April 23, 2018
64740	12/01/2009	SIFA Maize Meal (and logo)	30	SIFA MILLERS LTD	January 12, 2019
70552	28/02/2011	GUMBA (and logo)	35, 38, 42	ESSAR TELECOM LIMITED	February 28, 2021
80807	20/11/2013	easycook (and logo)	8 and 21	BRAND IMPORTS (AFRICA) LIMITED	November 20, 2023
86213	09/02/2015	TOP MOOD	33	WELTECH AGENCIES E.A. LIMITED	February 9, 2025

## 9.9 Surrender

## 10.0 MADRID APPLICATIONS ACCEPTED FOR REGISTRATION

The following are the marks whose international registration has been notified to Kenya as a designated

contracting Party by the International Bureau, World Intellectual Property Organization (WIPO) and which are governed by the Madrid Agreement and the Madrid Protocol. The prescribed period of twelve (12) months and eighteen months (18) respectively for refusal of the marks commences from the notification date indicated herein for each mark.

**NOTICE** is given that any person who has grounds of opposition to the registration of any of the marks may, in accordance with the provisions of rule 11(1) of the Trade Marks (International Registration) Rules 2003, file a notice of opposition within sixty (60) days from the date of this Journal on form TM. No. 6 (in duplicate) together with a fee of Ksh 5,000/= (Kenyan residents) or US\$ 250 (non residents).

The period of filing the notice of opposition may be extended by the Registrar of Trade Marks as prescribed in the Trade Mark Rules. Any request for such extension should be made to the Registrar before the expiry of the sixty (60) day statutory period.

All the details of the marks advertised herein are available on WIPO's website [www.wipo.int/romarin](http://www.wipo.int/romarin)

03.2026

(210) : 532742 (151) : 28/11/2025 (511) : 6 (732) : MIGUA Fugensysteme GmbH of Dieselstrasse 20 42489 Wülfrath, Germany

**MIGUA**  
**ELUMIS**

(210) : 773659 (151) : 20/01/2026 (511) : 5 (732) : SYNGENTA CROP PROTECTION AG of Rosentalstrasse 67 CH-4058 Basel, Switzerland

Allen Carr's  
**Easyway**

(210) : 853761 (151) : 07/10/2025 (511) : 9 (732) : Allen Carr's Easyway (International) Ltd of Park House, 14 Pepys Road Raynes Park, London SW20 8NH, United Kingdom

**EBRD**

(210) : 981682 (151) : 27/11/2025 (511) : 35 (732) : The European Bank for Reconstruction and Development of 5 Bank Street London E14 4BG, United Kingdom

(210) : 981686 (151) : 27/11/2025 (511) : 35 (732) : The European Bank for Reconstruction and Development of 5 Bank Street London E14 4BG, United Kingdom

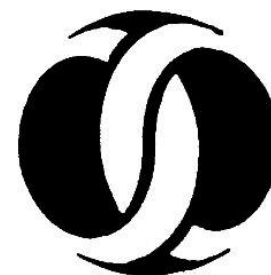

(210) : 991340 (151) : 28/01/2026 (511) : 3 (732) : COSWELL S.p.A. of Via P. Gobetti, 4 I-40050 Funo di Argelato, Italy

**BIOREPAIR**

(210) : 1067855 (151) : 22/12/2025 (511) : 9 (732) : GS Yuasa Corporation of 1, Inobaba-cho, Nishinosho, Kisshoin, Minami-ku, Kyoto-shi Kyoto 601-8520, Japan



(210) : 1176019 (151) : 22/12/2025 (511) : 5 (732) : Gan & Lee Pharmaceuticals. of No. 8 Jingsheng North 3rd Street, Golden Bridge Science Industrial Base, Zhongguancun Science Park, Tongzhou District Beijing, China

**Gan&Lee**

(210) : 1239741 (151) : 14/01/2026 (511) : 3 (732) : THD S.P.A. of VIA PER CARPI 15/B I-42015 CORREGGIO (RE), Italy

**THD**

(210) : 1259745 (151) : 03/02/2026 (511) : 30 (732) : Single Origin Pty Ltd of 28B Cranbrook Street Botany NSW 2019, Australia

**SINGLE**

(210) : 1280268 (151) : 20/11/2025 (511) : 5 (732) : MAYOLY PHARMA FRANCE of 3 place Renault F-92500 Rueil-Malmaison, France

**SMECTAGO**

(210) : 1298651 (151) : 05/02/2026 (511) : 1 (732) : Chemetall GmbH of Trakehner Strasse 3 60487 Frankfurt am Main, Germany

**GARDO**

(210) : 1336310 (151) : 19/12/2025 (511) : 43 (732) : Sunflower Management GmbH & Co. KG of Landsberger Allee 117A 10407 Berlin, Germany



03.2026

(210) : 1371326 (151) : 22/12/2025 (511) : 5 (732) : GAN & LEE PHARMACEUTICALS. of NO. 8 JINGSHENG NORTH 3RD STREET, GOLDEN BRIDGE SCIENCE INDUSTRIAL BASE, ZHONGGUANCUN SCIENCE PARK, TONGZHOU DISTRICT BEIJING, China



(210) : 1452735 (151) : 24/11/2025 (511) : 29 (732) : DELIFRANCE S.A. of 99 rue Mirabeau F-94200 IVRY-SUR-SEINE, France

*Déifrance*

(210) : 1491924 (151) : 29/01/2026 (511) : 9 (732) : SHOKZ (SINGAPORE) PTE. LTD. of 11 NORTH BUONA VISTA DRIVE, #16-09 THE METROPOLIS SINGAPORE 138589, Singapore

AFTERSH@KZ

(210) : 1493384 (151) : 25/11/2025 (511) : 1 (732) : ALDO NASI; RIFAT NASI of Yildiz Posta Cad. Vefabey Sok. Yesil Apt. B Blok No:7 K:4 D:13 Gayrettepe Besiktas TR-34349 Istanbul, Turkey; Yildiz Posta Cad. Vefabey Sok. Yesil Apt. B Blok No:7 K:4 D:13 Gayrettepe Besiktas TR-34349 Istanbul, Turkey



(210) : 1551471 (151) : 03/02/2026 (511) : 12 (732) : HYUNDAI MOTOR COMPANY of 12, Heolleung-ro, Seocho-gu Seoul, Republic of Korea

BAYON

(210) : 1573298 (151) : 02/02/2026 (511) : 10 (732) : TSK Laboratory Europe B.V. of Gemullehoekenweg 42 NL-5062 CD Oisterwijk, Netherlands

TSKiD

(210) : 1609842 (151) : 02/02/2026 (511) : 10 (732) : TSK Laboratory Europe B.V. of Gemullehoekenweg 42 NL-5062 CD Oisterwijk, Netherlands



(210) : 1609978 (151) : 02/02/2026 (511) : 10 (732) : TSK Laboratory Europe B.V. of Gemullehoekenweg 42 NL-5062 CD Oisterwijk, Netherlands

TSK

(210) : 1617114 (151) : 10/12/2025 (511) : 33 (732) : SUNTORY HOLDINGS LIMITED of 1-40, Dojimahama 2-chome, Kita -Ku, Osaka-Shi Osaka, Japan

YAMAZAKI

(210) : 1623945 (151) : 29/01/2026 (511) : 9 (732) : FIGMA, INC. of 116 New Montgomery Street, Suite 400 San Francisco CA 94105, United States of America

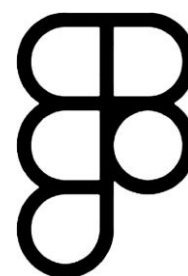

(210) : 1630058 (151) : 29/01/2026 (511) : 9 (732) : SHOKZ (SINGAPORE) PTE. LTD. of 11 NORTH BUONA VISTA DRIVE, #16-09 THE METROPOLIS SINGAPORE 138589, Singapore

opensound

(210) : 1633504 (151) : 15/01/2026 (511) : 9 (732) : WECO S.R.L. of Viale Kennedy, 113 I-50038 SCARPERIA (FI), Italy



03.2026

(210) : 1635745 (151) : 18/12/2025 (511) : 9 (732) : Rigo Trading S.A. of  
6, Route de Trèves, EBBC, Building E L-2633 Senningerberg, Luxembourg

**HARIBO**

(210) : 1635754 (151) : 18/12/2025 (511) : 9 (732) : HARIBO Holding GmbH  
& Co. KG of Dr.-Hans-und-Paul-Riegelstrasse 1 53501 Grafschaft, Germany

(210) : 1660631 (151) : 17/11/2025 (511) : 41 (732) : Global Swiss  
Learning AG of Poststrasse 24 CH-6300 Zug, Switzerland



(210) : 1688239 (151) : 24/01/2026 (511) : 3 (732) : Aritzia LP of 118- 611  
Alexander Street Vancouver BC V6A 1E1, Canada

**ARITZIA**

(210) : 1701609 (151) : 30/09/2025 (511) : 9 (732) : TIMATEC Co., Ltd. of  
C-#516, 54 Gwangjinmal-ro, Uiwang-si Gyeonggi-do, Republic of Korea

**TIMADRONE**

(210) : 1714687 (151) : 16/12/2025 (511) : 3 (732) : LAKA COSMETICS INC.  
of 7F, 92, Yanghwa-ro Mapo-gu, Seoul, Republic of Korea

**Laka**

(210) : 1721544 (151) : 06/01/2026 (511) : 5 (732) : DAIICHI SANKYO  
COMPANY, LIMITED of 3-5-1, Nihonbashi Honcho, Chuo-ku Tokyo 103-8426,  
Japan

**DATROWAY**

(210) : 1725380 (151) : 20/01/2026 (511) : 3 (732) : FRAGRANCE PASSION  
of 10 rue des Trois Croissants F-44000 Nantes, France

**SORA DORA**

(210) : 1749090 (151) : 05/01/2026 (511) : 4 (732) : Zhejiang Lifeng  
Machinery Parts Co., LTD. of No. 81, Guangda Street, Regress Project,  
Jinsha New Area, Longquan, Lishui 325000 Zhejiang, China

**LEFONG**

(210) : 1752570 (151) : 11/11/2025 (511) : 9 (732) : Huan Hu of No.5,  
Tianli Group, Baimi Village, Baishui Town, Miluo City Hunan Province, China

**SOCOVEZ**

(210) : 1755417 (151) : 12/01/2026 (511) : 1 (732) : TIMAB MAGNESIUM of  
57 boulevard Jules Verger F-35800 DINARD, France

**SUNFORTIS**

(210) : 1755613 (151) : 22/01/2026 (511) : 35 (732) : Guangdong Kuaike  
E-commerce Co., Ltd. of 1601, Building 2, Shenzhen New Generation  
Industrial Park, No. 136, Zhongkang Road, Meidu Community, Meilin Street,  
Futian District, Shenzhen 518000 Guangdong, China

**KiKV**

(210) : 1760401 (151) : 21/01/2026 (511) : 9 (732) : Shanghai United  
Imaging Healthcare Co., Ltd. of No. 2258 Chengbei Rd., Jiading District  
Shanghai, China

**uOmnispace**

(210) : 1776798 (151) : 11/10/2025 (511) : 22 (732) : CHANGHONG  
PLASTICS GROUP IMPERIAL PLASTICS CO., LTD. of No. 4999, Express Way,  
Anhui Xinwu Economic Development Zone, Wanzhi Town, Wuhu County  
Anhui Province, China

**CHS**

03.2026

(210) : 1793038 (151) : 25/12/2025 (511) : 25 (732) : MEHMET ASLANTAS  
of Basak mah. Mevlana Celaledini Rumi Cad., Misstanbul Evleri 3.Ada Sitesi  
No: 4m, ic kapi no: 15 Basaksehir Istanbul, Turkey



(210) : 1793362 (151) : 06/02/2026 (511) : 5 (732) : NOVO NORDISK  
HEALTH CARE AG of The Circle 32/38 CH-8058 Zürich, Switzerland

**Omredify**

(210) : 1797892 (151) : 19/01/2026 (511) : 3 (732) : LABORATOIRE NIGY  
of 240 rue Louis Charles Vernin F-77190 DAMMARIÉ-LES-LYS, France



(210) : 1806953 (151) : 26/11/2025 (511) : 12 (732) : ZHEJIANG GEELY  
HOLDING GROUP CO., LTD. of 1760 JIANGLING ROAD, BINJIANG DISTRICT,  
HANGZHOU ZHEJIANG, China

**GEELY E5**

(210) : 1808305 (151) : 15/01/2026 (511) : 3 (732) : Dr.nineteen Co., Ltd.  
of 1F, 2F, 3F, 6, Samseong-ro 144-gil, Gangnam-gu Seoul, Republic of Korea

**Dr.nineteen**

(210) : 1818203 (151) : 27/01/2026 (511) : 3 (732) : Guangdong Pet Joy  
No.1 Management Co., Ltd. of 910-2, Yongfeng Comprehensive Building,  
Yongfeng Community, Xixiang Street, Bao'an District, Shenzhen Guangdong,  
China



(210) : 1823491 (151) : 23/01/2026 (511) : 14 (732) : Guangdong Kuaik  
E-commerce Co., Ltd. of 1601, Building 2, Shenzhen New Generation  
Industrial Park, No. 136, Zhongkang Road, Meidu Community, Meilin Street,  
Futian District, Shenzhen Guangdong, China

**XII SPACE**

(210) : 1851177 (151) : 26/11/2025 (511) : 12 (732) : ZHEJIANG GEELY  
HOLDING GROUP CO., LTD. of 1760 Jiangling Road, Binjiang District,  
Hangzhou Zhejiang, China

**EM-i  
LITO**

(210) : 1861083 (151) : 24/09/2025 (511) : 9 (732) : Guangzhou Lito  
Technology Co., . Ltd of RM1114, South Tower, No.159, Qiaozhong Middle  
RD, Liwan DIST, Guangzhou City Guangdong Province, China

*Sevan Bıçakçı*  

(210) : 1866165 (151) : 05/09/2025 (511) : 3 (732) : SEVAN BIÇAKÇI of  
Göktürk Merkez Mah. Iskele Yolu Sk., No: 5 İç Kapi No: 1 Eyüpsultan /  
Istanbul, Turkey

(210) : 1867980 (151) : 21/10/2025 (511) : 5 (732) : NOVARTIS AG of CH-  
4002 BASEL, Switzerland

**LOKIMDO**

(210) : 1878057 (151) : 25/11/2025 (511) : 1 (732) : ASP Global  
Manufacturing GmbH of Im Majorenacker 10 CH-8207 Schaffhausen,  
Switzerland

**STERRAD SI**

(210) : 1881953 (151) : 11/02/2026 (511) : 5 (732) : AstraZeneca Ireland  
Limited of College Business & Technology Park Blanchardstown Dublin 15  
D15 R925, Ireland



03.2026

(210) : 1884601 (151) : 24/09/2025 (511) : 37 (732) : REFORM SPOR SİSTEMLERİ SANAYİ VE TİCARET ANONİM ŞİRKETİ of MAHMUTBEY MAH. 2475. SK. 4 -6 21, Bağcılar İstanbul, Turkey



(210) : 1886070 (151) : 24/09/2025 (511) : 5 (732) : The Government Pharmaceutical Organization of 75/1 Rama VI Road, Thung Phaya Thai Sub-district Ratchathewi District, Bangkok, 10400, Thailand

**SIDEGRA**

(210) : 1886111 (151) : 07/06/2025 (511) : 19 (732) : Foshan Team Value Decorative Materials Co., Ltd. of No 6, Floor 2, Bldg1, No 3 Lvjing West Road, Shiwan Town, Chancheng District, Foshan City 528000 Guangdong Province, China

**TEAM VALUE**

(210) : 1886827 (151) : 02/10/2025 (511) : 3 (732) : PARFUMS CHRISTIAN DIOR of 33 avenue Hoche F-75008 Paris, France

**DIOR ADDICT PURPLE GLOW**

(210) : 1886982 (151) : 07/01/2026 (511) : 5 (732) : Novo Nordisk A/S of Novo Allé DK-2880 Bagsværd, Denmark

**NovoCare**

(210) : 1887058 (151) : 01/10/2025 (511) : 1 (732) : Mitsubishi Chemical Corporation of 1-1, Marunouchi 1-Chome, Chiyoda-ku Tokyo 100-825, Japan

**SoarnoL**

(210) : 1888930 (151) : 09/06/2025 (511) : 7 (732) : R.KUMARAVELU, Mrs. HOMAI KUMARAVELU (Trustee representing "The Chrysanthemum Trust") and Mrs. GULNARHIRJI ADENWALLA (Trustee representing "The Marigold Trust"), Partners of: AQUASUB ENGINEERING of Thudiyalur Post, Coimbatore Tamil Nadu 641034, India



(210) : 1888931 (151) : 05/06/2025 (511) : 7 (732) : R.KUMARAVELU, Mrs. HOMAI KUMARAVELU (Trustee representing "The Chrysanthemum Trust") and Mrs. GULNARHIRJI ADENWALLA (Trustee representing "The Marigold Trust"), Partners of: AQUASUB ENGINEERING of Thudiyalur Post, Coimbatore Tamil Nadu 641034, India

**AQUATEX**

(210) : 1889015 (151) : 26/09/2025 (511) : 10 (732) : Fresenius Medical Care Deutschland GmbH of Else-Kröner-Str. 1 61352 Bad Homburg, Germany

**plasmaFlux alpha**

(210) : 1889098 (151) : 24/09/2025 (511) : 14 (732) : ROLEX SA of 3-5-7 rue François-Dussaud CH-1211 Genève 26, Switzerland

**TRU-BEAT**

(210) : 1889502 (151) : 05/08/2025 (511) : 12 (732) : Chery Automobile Co., Ltd. of No.8 Changchun Road, Economy & Technology Development Zone, Wuhu City 241009 Anhui Province, China



(210) : 1889640 (151) : 05/06/2025 (511) : 7 (732) : R.KUMARAVELU, Mrs. HOMAI KUMARAVELU (Trustee representing "The Chrysanthemum Trust") and Mrs. GULNAR HIRJI ADENWALLA (Trustee representing "The Marigold Trust"), Partners of: AQUASUB ENGINEERING of Thudiyalur Post, Coimbatore Tamil Nadu 641034, India

**atx**

(210) : 1890105 (151) : 06/10/2025 (511) : 9 (732) : Pearson Plc of 80 Strand London WC2R 0RL, United Kingdom

**Pearson**

03.2026

(210) : 1890180 (151) : 06/08/2025 (511) : 9 (732) : Euro Games Technology Ltd. of Panorama Sofia Str. 6, Richhill Business Center, ground floor, Vitosha Region BG-1766 Sofia, Bulgaria

**Burning Shots**

(210) : 1890279 (151) : 19/09/2025 (511) : 28 (732) : ZURU IP LIMITED of RM 1201-04, 12/F ENERGY PLAZA, 92 GRANVILLE RD, TSIM SHA TSUI KOWLOON, HONG KONG, China

**ZURU MINNEE**

(210) : 1890282 (151) : 24/09/2025 (511) : 28 (732) : ZURU IP LIMITED of RM 1201-04, 12/F ENERGY PLAZA, 92 GRANVILLE RD, TSIM SHA TSUI, KOWLOON HONG KONG, Switzerland

**ZURU BALLERS**

(210) : 1891122 (151) : 26/09/2025 (511) : 9 (732) : OSYPKA AG of Earl-H.-Wood-Strasse 1 79618 Rheinfelden-Baden, Germany

**OSYPKA GmbH**

(210) : 1891671 (151) : 06/08/2025 (511) : 5 (732) : Hangzhou Haoyue Personal Care Co.,Ltd. of No.655 Hongfeng Road, Linping Economic And Technological Developmant Zone, Donghu Street, Linping District, Hangzhou City Zhejiang Province, China

**NANAKIA**

(210) : 1892275 (151) : 08/08/2025 (511) : 7 (732) : S3C of 4B Rue Jean Moulin F-82200 MOISSAC, France

**AQUAEXO**

(210) : 1892422 (151) : 26/09/2025 (511) : 29 (732) : AICE GROUP HOLDINGS PTE. LTD. of 80 ROBINSON ROAD, #02-00 SINGAPORE 068898, Singapore



(210) : 1892974 (151) : 26/09/2025 (511) : 9 (732) : OSYPKA GmbH of Earl-H.-Wood-Strasse 1 79618 Rheinfelden-Baden, Germany

 **OSYPKA**

(210) : 1893195 (151) : 01/10/2025 (511) : 14 (732) : ROLEX SA of Rue François-Dussaud 3-5-7 CH-1211 Genève 26, Switzerland

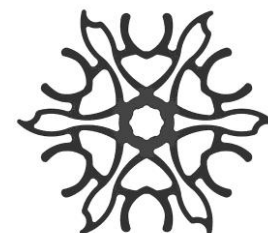

(210) : 1893599 (151) : 28/09/2025 (511) : 25 (732) : Guangzhou Guangtai International Trade Co., Ltd. of Room B23, 502, Building 50-3, No. 200, Fangcun Avenue East Road, Liwan District, Guangzhou City Guangdong Province, China



**WILL COZY**

(210) : 1893618 (151) : 19/09/2025 (511) : 11 (732) : Foshan MAGE Bathroom Co., Ltd. of No.18-28th, Building 26th, CASA Sanitarywares Market, Jihua 4th Road, Shiwan Street Town, Chancheng District, Foshan City Guangdong Province, China

**mage**

(210) : 1893841 (151) : 25/09/2025 (511) : 20 (732) : Foshan Fansi Ai Furniture Co., Ltd. of 201, 2nd Floor, Comprehensive Building, Huang Haochang and Chen Zhaojia, M5 Plot, Jiujiang Logistics Industrial Park, Shijiang Village, Jiujiang Town Nanhai District, Foshan City, Guangdong, China

**Fansace**

03.2026

(210) : 1894159 (151) : 01/09/2025 (511) : 16 (732) : CL Pipe and Plastic Company of Plot No. 226 - Industrial Zone A5 10th of Ramadan Sharqia, Egypt

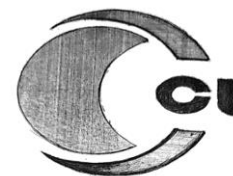

سي ال

(210) : 1894173 (151) : 21/01/2026 (511) : 43 (732) : Hilton Worldwide Manage Limited of Maple Court Central Park, Reeds Crescent Watford, Hertfordshire WD24 4QQ, United Kingdom

**OUTSET COLLECTION BY  
HILTON**

(210) : 1894217 (151) : 22/08/2025 (511) : 7 (732) : INTEVISION TOOLS CO. PTE. LTD. of 55 UBI AVENUE 1, #02-05 UBI 55 SINGAPORE 408935, Singapore

**TOGROUP**

(210) : 1894266 (151) : 07/10/2025 (511) : 34 (732) : Nakhla Tobacco Co S.A.E. of Unit (03 - 02 - 03) - Second Floor Building 3, Administrative and Commercial Market Area (A), 90th Street, Fifth Settlement New Cairo, Egypt



(210) : 1894347 (151) : 19/11/2025 (511) : 1 (732) : HAIFA NEGEV TECHNOLOGIES LTD. of 30 Matam St. 3190500 Haifa, Israel

**MULTICOTE**

(210) : 1894351 (151) : 25/11/2025 (511) : 45 (732) : Oral Roberts University of 7777 South Lewis Ave. Tulsa OK 74171, United States of America

**EMPOWERED21**

(210) : 1894836 (151) : 25/08/2025 (511) : 3 (732) : Lord for Trade & Industry of 12 Safia Zaghloul Street. Sharq District Port Said, Egypt



(210) : 1894945 (151) : 07/10/2025 (511) : 9 (732) : Apple Inc. of One Apple Park Way Cupertino CA 95014, United States of America

**SNEAKY SASQUATCH**

(210) : 1895212 (151) : 29/07/2025 (511) : 41 (732) : FEMM Foundation of 228 East 71st Street New York NY 10021, United States of America

**TEENFEMM**

(210) : 1895350 (151) : 21/11/2025 (511) : 9 (732) : PASSBOLT S.A. of 9, Avenue du Blues L-4368 Belvaux, Luxembourg

**PASSBOLT**

(210) : 1895573 (151) : 30/06/2025 (511) : 7 (732) : LMW LIMITED of Perianaickenpalayam, Coimbatore Tamil Nadu 641020, India

**LMW**

03.2026

(210) : 1895704 (151) : 05/08/2025 (511) : 1 (732) : TOYOTA JIDOSHA KABUSHIKI KAISHA (also trading as TOYOTA MOTOR CORPORATION) of Toyota-cho, Toyota-shi 1 Aichi-ken 471-8571, Japan



(210) : 1895705 (151) : 05/08/2025 (511) : 1 (732) : TOYOTA JIDOSHA KABUSHIKI KAISHA (also trading as TOYOTA MOTOR CORPORATION) of Toyota-cho, Toyota-shi 1 Aichi-ken 471-8571, Japan

**LAND CRUISER**

(210) : 1895961 (151) : 20/11/2025 (511) : 30 (732) : OBA MAKARNACILIK SANAYI VE TICARET ANONIM SIRKETI of BASPINAR(ORGANIZE)OSB MAH. O.S.B. 4.BÖLGE 83422 NOLU CAD. NO:1 SEHITKAMIL GAZIANTEP, Turkey



(210) : 1896098 (151) : 08/12/2025 (511) : 5 (732) : VAFO Brands s.r.o. of K Brudku 94 CZ-252 19 Chrástany, Czech Republic

**COUNTRY DOG**

(210) : 1896127 (151) : 21/11/2025 (511) : 9 (732) : PASSBOLT S.A. of 9, Avenue du Blues L-4368 Belvaux, Luxembourg

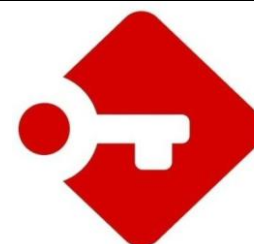

(210) : 1896316 (151) : 21/08/2025 (511) : 35 (732) : International Agency for the Prevention of Blindness of The Northern Shell Building 4th Floor, 10 Lower Thames Street London EC3R 6AF, United Kingdom

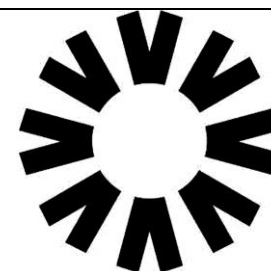

(210) : 1896317 (151) : 21/08/2025 (511) : 35 (732) : International Agency for the Prevention of Blindness of The Northern Shell Building 4th Floor, 10 Lower Thames Street London EC3R 6AF, United Kingdom

**IAPB CHANGING HOW EVERYONE, EVERYWHERE SEES**

(210) : 1896541 (151) : 12/08/2025 (511) : 38 (732) : BERNARETARO LIMITED of ARCHIEPISKOPOU KYPRIANOU & AYIOU ANDREOU 1, LOUCAIDES BUILDING, 2ND FLOOR, FLAT/OFFICE 21 CY-3036 LIMASSOL, Cyprus

**Dafanews**

(210) : 1896599 (151) : 29/07/2025 (511) : 18 (732) : Riding Safari Club S.r.l. of Via Manfredo Camperio 9 I-20123 Milano, Italy

**RSC**

(210) : 1896973 (151) : 25/11/2025 (511) : 36 (732) : Oral Roberts University of 7777 South Lewis Avenue Tulsa OK 74171, United States of America

**EVERYONE**

03.2026

(210) : 1896974 (151) : 25/11/2025 (511) : 45 (732) : Oral Roberts University of 7777 South Lewis Ave. Tulsa OK 74171, United States of America



(210) : 1897046 (151) : 19/11/2025 (511) : 9 (732) : MAINE'S INTERNATIONAL PRIVATE LIMITED of 26 JALAN ISHAK SINGAPORE 419356, Singapore

**FIDELA**

(210) : 1897058 (151) : 23/09/2025 (511) : 3 (732) : Jin Shenghai of No. 377, Qianyangfang Village, Xinqian Street, Huangyan District, Taizhou City Zhejiang Province, China

*Fajaž*

(210) : 1897088 (151) : 10/10/2025 (511) : 3 (732) : Guangzhou Pinshun Cosmetics Co., Ltd. of Room 513B428, No. 1 Qifu Road, Baiyun District, Guangzhou City Guangdong Province, China

slavina

(210) : 1897103 (151) : 19/08/2025 (511) : 9 (732) : Shenzhen ZhuoYe ChuangYi Co., Ltd. of Room 602-1, Building 6, Shenzhen Bay Technology Eco-Park, No. 6 Gaoxin South 9th Road, Gaoxin Community, Yuehai Street, Nanshan District, Shenzhen Guangdong, China

**GravaStar**

(210) : 1897115 (151) : 26/08/2025 (511) : 9 (732) : Društvo za trgovija i usluga EVRO GEJMS TEHNOLODŽI DOOEL Skopje of Ul. Boris Trajkovski Br. 214 A, Kisela Voda 1000 Skopje, The former Yugoslav Republic of Macedonia

DIAMOND CLOVER

(210) : 1897122 (151) : 20/11/2025 (511) : 25 (732) : PUMA SE of PUMA Way 1 91074 Herzogenaurach, Germany



(210) : 1897123 (151) : 20/11/2025 (511) : 25 (732) : PUMA SE of PUMA Way 1 91074 Herzogenaurach, Germany

**PUMA  
GO WILD**

(210) : 1897191 (151) : 25/08/2025 (511) : 9 (732) : Xiamen Joint Tech. Co., Ltd. of One of the three floors of Building 1, No. 268 Houxiang Road, Xinyang Industrial Zone, Haicang District, Xiamen City Fujian Province, China

**Joint**

(210) : 1897199 (151) : 01/10/2025 (511) : 9 (732) : SAMSUNG ELECTRONICS CO., LTD. of 129, Samsung-ro, Yeongtong-gu Suwon-si, Gyeonggi-do, Republic of Korea

**MovingStyle**

(210) : 1897247 (151) : 25/09/2025 (511) : 1 (732) : CHANGHUA CHEMICAL TECHNOLOGY CO., LTD. of No.20 Beijing Road Yangtze River International Chemical Industry Park, Zhangjiagang, Suzhou Jiangsu Province, China

**Hicclaim**

(210) : 1897255 (151) : 21/11/2025 (511) : 12 (732) : Yiwu Rolie Auto Parts Co., Ltd. of Rm. 306, 3/F, Building 3, No. 621, Airport Road, Beiyuan Street, Yiwu City, Jinhua City 322023 Zhejiang Province, China

**BullHorse**

03.2026

(210) : 1897271 (151) : 06/08/2025 (511) : 9 (732) : EGT DIGITAL LTD. of "Panorama Sofia" Str. 6, Business Center "Richhill", block A BG-1766 Sofia, Bulgaria



(210) : 1897298 (151) : 11/08/2025 (511) : 9 (732) : WENZHOU KINEE ELECTRICAL CO., LTD. of Floor 2&3, Room 101, Building 24, Wenzhou Wenbo Technology Industrial Park, No. 706 Yanyun Road, Kunpeng Subdistrict, Wenzhou Marine Economic Development Demonstration Zone, Wenzhou City Zhejiang Province, China



(210) : 1897306 (151) : 15/09/2025 (511) : 9 (732) : Shenzhen Rongchuangxin Technology Co., Ltd. of 3rd Floor, Building 8, Lantian Science and Technology Park, Ditang Road, Shasi Community, Shajing Sub-district, Bao'an District, Shenzhen Guangdong, China

PM·PIXEL&amp;MART

(210) : 1897316 (151) : 16/09/2025 (511) : 9 (732) : Laisai Laser Technology Co., Ltd. of No.106 and 108, Xinzhu 2nd Road, Xinbei District, Changzhou City 213000 Jiangsu Province, China



(210) : 1897522 (151) : 26/11/2025 (511) : 29 (732) : Jiangxi Dedu Food Technology Co., Ltd. of No.399, Zhenxing South Avenue, Shicheng County, Ganzhou City 342700 Jiangxi Province, China

DEDU FOOD

(210) : 1897542 (151) : 24/11/2025 (511) : 3 (732) : SHANGHAI BAIFENG INVESTMENT CO., LTD. of Room 309D, No. 21, Lane 596, Yanan Central Road, Jingan District Shanghai City, China

Dr.870

(210) : 1897554 (151) : 26/09/2025 (511) : 12 (732) : Tianjin Qixin Technology Co., Ltd. of Area A-007, No.5 Jianxin Road, Hedong District Tianjin, China



U~WINFLY

(210) : 1897633 (151) : 31/07/2025 (511) : 9 (732) : Guangzhou Jingtuo Technology Co., Ltd. of Unit 1506, Building B3, No. 42 Dongzhong Road, Huangpu District, Guangzhou City Guangdong Province, China

WHALEROAD

(210) : 1897691 (151) : 10/10/2025 (511) : 5 (732) : XMXYG CORPORATION of Unit 01, 10F, Bldg A, XMXYG CORP Bldg, No. 81, Xiangyu Rd Xiamen Area of Fujian FTZ, China

X M X Y G

(210) : 1897692 (151) : 26/11/2025 (511) : 7 (732) : Shangqiu City Jingcheng Measuring Tools Co., Ltd. of Shaogang Village, Shaogang Township, Yucheng County, Shangqiu City 476300 Henan Province, China



(210) : 1897712 (151) : 24/11/2025 (511) : 28 (732) : ZURU IP LIMITED of RM 1201-04, 12/F ENERGY PLAZA 92 GRANVILLE RD TSIM SHA TSUI KOWLOON, China



(210) : 1897770 (151) : 21/11/2025 (511) : 11 (732) : Shinflow JAPAN K.K. of Asia One Center, 1-17, Koyochi Naka, Higashinada-ku, Kobe Hyogo 658-0032, Japan

ShinWave

03.2026

(210) : 1898033 (151) : 28/11/2025 (511) : 33 (732) : CLAN CAMPBELL (WHISKY) LIMITED of 50 Lothian Road, Festival Square Edinburgh, Scotland EH3 9WJ, United Kingdom



(210) : 1898038 (151) : 25/11/2025 (511) : 35 (732) : Fuheng Trading (Yiwu) Co., Ltd. of No. 601, Building 4, High-Tech Industrial Park, Jingju East Road, Houzhai Subdistrict, Yiwu City, Jinhua City 322000 Zhejiang Province, China

RubyStar  
**ZENOVATE**

(210) : 1898039 (151) : 26/11/2025 (511) : 9 (732) : ZHUHAI ZIONADU TECHNOLOGY LIMITED of Room 468, 4th Floor, Building 2, No.378 Jinji Road, Xiangzhou District, Zhuhai City 519100 Guangdong Province, China

(210) : 1898046 (151) : 05/09/2025 (511) : 25 (732) : Zhu Hua of No. 99 Yunlu Village, Jindou Town, Yongchun County 362600 Fujian Province, China



(210) : 1898104 (151) : 09/12/2025 (511) : 3 (732) : ROHTO Pharmaceutical Co., Ltd. of 8-1, Tatsuminishi 1 Chome, Ikuno-ku, Osaka-shi Osaka 544-8666, Japan

SKIN AQUA

(210) : 1898123 (151) : 28/11/2025 (511) : 33 (732) : CLAN CAMPBELL (WHISKY) LIMITED of 50 Lothian Road, Festival Square Edinburgh, Scotland EH3 9WJ, United Kingdom



(210) : 1898124 (151) : 28/11/2025 (511) : 33 (732) : CLAN CAMPBELL (WHISKY) LIMITED of 50 Lothian Road, Festival Square Edinburgh, Scotland EH3 9WJ, United Kingdom

CLAN CAMPBELL FROM  
THE HEART OF THE  
HIGHLANDS

(210) : 1898191 (151) : 05/12/2025 (511) : 36 (732) : The Mended Hearts, Inc. of 1579 US Highway 19 South Leesburg GA 31763, United States of America

MENDED HEARTS  
GLOBAL

(210) : 1898344 (151) : 17/09/2025 (511) : 9 (732) : Euro Games Technology Ltd. of 6 Panorama Sofia Str., Richhill Business Center, ground floor Vitosha Region, BG-1766 Sofia, Bulgaria

Glamour of Empress

03.2026

(210) : 1898351 (151) : 19/11/2025 (511) : 29 (732) : CONSORZIO DEL FORMAGGIO PARMIGIANO REGGIANO of Via Kennedy, 18 I-42100 REGGIO EMILIA, Italy



(210) : 1900296 (151) : 19/12/2025 (511) : 9 (732) : COGNOSPHERE PTE. LTD. of 1 ONE-NORTH CRESCENT, #06-01/02 RAZER SEA HQ SINGAPORE 138538, Singapore

**VARSA PURA**

(210) : 1900298 (151) : 05/11/2025 (511) : 20 (732) : Hästens Sängar AB of Box 130 SE-731 23 Köping, Sweden

HÄSTENS SLEEP INSTRUMENT

(210) : 1900341 (151) : 16/12/2025 (511) : 7 (732) : Anker Innovations Limited of Unit 56, 8th Floor, Tower 2, Admiralty Centre, 18 Harcourt Road Hong Kong, China

**ANKER**

(210) : 1900344 (151) : 24/12/2025 (511) : 35 (732) : Arabian Milling and Food Industries Company of 16 Al-Iqbal Street, Victoria - Al-Rimal, Al-Montazah District Alexandria, Egypt



(210) : 1900382 (151) : 27/10/2025 (511) : 30 (732) : DENG ZHEN QIANG of No. 10 Fengming Street, Fenghuang Mingyuan, Country Garden, Zengcheng District, Guangzhou City Guangdong Province, China

**JANIAR**

(210) : 1900668 (151) : 26/12/2025 (511) : 1 (732) : Montachem International, Inc. of 200 South Andrews Avenue, Suite 702 Fort Lauderdale FL 33301, United States of America



MONTACHEM | ULTIMA

(210) : 1900803 (151) : 30/10/2025 (511) : 16 (732) : WENZHOU WENTAI PEN INDUSTRY CO., LTD of No. 185, Wenzhou Avenue, Wenzhou Zhejiang, China

**Wentai**

(210) : 1900814 (151) : 05/11/2025 (511) : 9 (732) : Loongson Technology Corporation Limited of Room 101, Building 4, No. 7 Dijin Road, Haidian District Beijing, China

**LoongArch**

(210) : 1900815 (151) : 15/05/2025 (511) : 9 (732) : AGÊNCIA PARA A MODERNIZAÇÃO ADMINISTRATIVA, I.P. of RUA DE SANTA MARTA, Nº 55 P-1150-294 LISBOA, Portugal

**gov.pt**

03.2026

(210) : 1900839 (151) : 04/11/2025 (511) : 9 (732) : SHENZHEN WOER HEAT-SHRINKABLE MATERIAL CO., LTD. of Woer Industrial Park, Lanjing North Road, Longtian Street, Pingshan District, Shenzhen City 518000 Guangdong Province, China



(210) : 1900872 (151) : 20/12/2025 (511) : 11 (732) : ROSEN ENDÜSTRIYEL SOGUTMA MAKINELERI SANAYI TICARET LIMITED SIRKETI of İNÖNÜ MAH. FATİH SULTAN CAD. 51, Torbalı Izmir, Turkey

(210) : 1900928 (151) : 26/06/2025 (511) : 1 (732) : Shenzhen Yinwang Intelligent Technologies Co., Ltd. of Room 101, Huawei Headquarters Office Building, Huawei, Vanke City Community, Bantian Street, Longgang District, Shenzhen 518129 Guangdong, China

(210) : 1901063 (151) : 24/12/2025 (511) : 3 (732) : G2Global Co. of 50 west street #22C New York NY 10006, United States of America

(210) : 1901212 (151) : 22/04/2025 (511) : 7 (732) : TANG Yonglin of Group 3, Caosan Village, Guzhen Town, Zhongshan City 528421 Guangdong Province, China



(210) : 1901269 (151) : 18/07/2025 (511) : 9 (732) : GUANGZHOU BEDFORD ELECTRIC EQUIPMENT CO., LTD. of Room 201/202, No.11 Yong'An Street, Chajiao, Liwan District, Guangzhou Guangdong Province, China



(210) : 1901345 (151) : 08/05/2025 (511) : 24 (732) : Li Dawei of No. 440 Fengyang Road, Xiangcheng District, Suzhou City Jiangsu Province, China



(210) : 1901371 (151) : 30/12/2025 (511) : 9 (732) : SAMSUNG ELECTRONICS CO., LTD. of 129, Samsung-ro, Yeongtong-gu Suwon-si, Gyeonggi-do 16677, Republic of Korea

(210) : 1901404 (151) : 30/12/2025 (511) : 9 (732) : SAMSUNG ELECTRONICS CO., LTD. of 129, Samsung-ro, Yeongtong-gu Suwon-si, Gyeonggi-do 16677, Republic of Korea

(210) : 1901415 (151) : 13/06/2025 (511) : 24 (732) : Jiangsu Canasin Weaving Co., Ltd of No.8 Tiejun Road, Economic Development Zone, Huai'an District, Huai'an City 223200 Jiangsu Province, China

(210) : 1901417 (151) : 10/06/2025 (511) : 12 (732) : Tenacity Auto Parts Co., Ltd. of No. 8, Rende Rd., Fengshan Vil., Hukou Township, Hsinchu County 100081 Taiwan, China

03.2026

(210) : 1901498 (151) : 31/10/2025 (511) : 36 (732) : East Sea Bai Dai Company Limited of Lot D3, Cam Ranh Peninsula Tourist Area Cam Lam Commune Khanh Hoa Province, Viet Nam



THE ANAM

(210) : 1901501 (151) : 05/11/2025 (511) : 9 (732) : Hengtong Optic-Electric Co., Ltd. of No. 88, Hengtong Avenue, Qidu Town, Wujiang District 215234 Jiangsu Province, China



(210) : 1901557 (151) : 15/09/2025 (511) : 33 (732) : Jani Organics of PO BOX 7114 Baltimore MD 21218, United States of America



(210) : 1901624 (151) : 15/12/2025 (511) : 9 (732) : Shenzhen HeyTap Technology Corp., Ltd. of 207-2, Block B, Fu'an Science & Technology Mansion, No. 13 Gaoxinnanyi Avenue, Yuehai Street, Nanshan District, Shenzhen GUANGDONG, China

Breeno

(210) : 1901735 (151) : 19/06/2025 (511) : 7 (732) : Shenzhen Yinwang Intelligent Technologies Co., Ltd. of Room 101, Huawei Headquarters Office Building, Huawei, Vanke City Community, Bantian Street, Longgang District, Shenzhen 518129 Guangdong, China

INWO

(210) : 1901806 (151) : 19/08/2025 (511) : 6 (732) : Yongkang Nanwei Electric Tools Co., Ltd. of 1st-3rd Floor, No. 25, Yantou Small and Micro Enterprise Park, Dongcheng Street, Yongkang City, Jinhua City 321300 Zhejiang Province, China

NANWEI

(210) : 1902063 (151) : 29/12/2025 (511) : 30 (732) : Samyang Foods Inc. of 104, Opaesan-ro 3-gil, Seongbuk-gu Seoul, Republic of Korea



(210) : 1902142 (151) : 23/12/2025 (511) : 36 (732) : Inter-Continental Hotels Corporation of Three Ravinia Drive, Suite 100 Atlanta GEORGIA 30346, United States of America

INTERCONTINENTAL

03.2026

(210) : 1902257 (151) : 10/11/2025 (511) : 9 (732) : MR - BUSINESS TEAM  
d.o.o. Kragujevac of Kralja Milana IV br. 86 34000 Kragujevac, Serbia



(210) : 1902288 (151) : 18/08/2025 (511) : 3 (732) : Shenzhen Purcotton  
Technology Co., Ltd. of No. 660 Bulong Road, Longhua Street, Longhua  
District, Shenzhen 518110 Guangdong, China



(210) : 1902352 (151) : 07/11/2025 (511) : 30 (732) : GOLDEN GATE  
GROUP JOINT STOCK COMPANY of No 60 Giang Van Minh street Ba Dinh ward  
Hanoi City, Viet Nam

FIRE PHOENIX

(210) : 1902730 (151) : 15/07/2025 (511) : 6 (732) : Guangdong Rongjian  
Investment Development Co., Ltd of Office Building No.1 Wende Second  
Street, High tech Zone, Zhaoqing City 526238 Guangdong Province, China

KENTEN

(210) : 1902732 (151) : 20/08/2025 (511) : 5 (732) : MYLAN LABORATORIES  
LIMITED of plot no. 564/a/22, road no. 92, jubilee hills, hyderabad  
telangana 500096, India

Dvey

(210) : 1902948 (151) : 17/07/2025 (511) : 4 (732) : SUNGROW  
RENEWABLES DEVELOPMENT CO., LTD. of No.2 Tianhu Road, High-tech  
Industry, Development Zone Hefei, China

Sunhome

(210) : 1903019 (151) : 16/12/2025 (511) : 1 (732) : Novozymes A/S of  
Krogshøjvej 36 DK-2880 Bagsværd, Denmark

JAVORA

(210) : 1903054 (151) : 16/09/2025 (511) : 31 (732) : RHODES PETCARE  
LIMITED of Unit 1201-04, 06-07, 12/F, Energy Plaza, 92 Granville Road, Tsim  
Sha Tsui East, Kowloon Hong Kong, China



(210) : 1903067 (151) : 17/06/2025 (511) : 41 (732) : Campus Crusade for  
Christ, Inc. of 100 Lake Hart Drive MC 3500, Attn: General Counsel's Office  
Orlando FL 32832, United States of America

**CAMPUS CRUSADE FOR  
CHRIST INTERNATIONAL**

(210) : 1903081 (151) : 06/11/2025 (511) : 9 (732) : Wells Fargo &  
Company of 333 Market St San Francisco CA 94105, United States of America

WELLS FARGO

(210) : 1903300 (151) : 24/12/2025 (511) : 26 (732) : AKSA AKRILIK KIMYA  
SANAYII ANONIM SIRKETI of Merkez Mahallesi, Ali Raif Dinçkök Caddesi No:2,  
Tasköprü, Çiftlikköy TR-77602 Yalova, Turkey

Acrybella

(210) : 1903452 (151) : 25/12/2025 (511) : 35 (732) : MEHMET ASLANTAS  
of Basak Mah. Mevlana Celaleddini Rumi Cad., Misstanbul Evleri 3.Ada Sitesi  
No: 4M İç Kapi No: 15, Basaksehir Istanbul, Turkey



(210) : 1903521 (151) : 24/07/2025 (511) : 3 (732) : KHADI AND VILLAGE  
INDUSTRIES COMMISSION of gramodaya, 3, irla road, vile parle (w), mumbai  
maharashtra 400056, India

KHADI

03.2026

(210) : 1903596 (151) : 31/12/2025 (511) : 7 (732) : VIDAA (Netherlands) International Holdings B.V. of Strawinskyaan 3051, Atrium Building, 4th Floor NL-1077 ZX Amsterdam, Netherlands

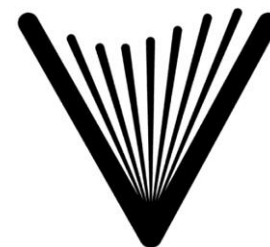

**VERSAFOAM**

(210) : 1903756 (151) : 29/12/2025 (511) : 9 (732) : Guess? IP Holder L.P. of 1444 South Alameda Street Los Angeles CA 90021, United States of America

**MARCIANO**

(210) : 1903868 (151) : 19/12/2025 (511) : 9 (732) : International Business Machines Corporation of New Orchard Road Armonk NY 10504, United States of America

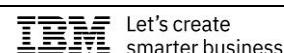

(210) : 1903953 (151) : 13/08/2025 (511) : 23 (732) : XIAMEN FORTUNE TRADING CO., LTD. of Unit 3, 17th Floor, Bai Nao Hui Technology Building, NO.76 South Hu Bin Road, Xiamen Fujian, China



(210) : 1904008 (151) : 08/05/2025 (511) : 8 (732) : LIAO YI HO; RIO TOOLS CO., LTD. of No. 11, Ln. 451, Tucheng Rd., Dali Dist., Taichung City 412032 Taiwan, China; No. 32, Ln. 496, Guangxing Rd., Taiping Dist., Taichung City 411008 Taiwan, China



(210) : 1904015 (151) : 08/11/2025 (511) : 3 (732) : Du Junliang of Room 604, Unit 3, Building 13, Chengbei Commercial Center, Houzhai Street, Yiwu City, Jinhua City Zhejiang Province, China

**DUNUF**

(210) : 1904456 (151) : 19/12/2025 (511) : 16 (732) : POGOSSIAN SEMEN HMAYAKI of Tavrizyan street, 46 0012 Yerevan, Armenia



(210) : 1904770 (151) : 24/12/2025 (511) : 5 (732) : Otsuka Pharmaceutical Co., Ltd. of 2-9 Kanda-Tsukasamachi, Chiyoda-ku Tokyo 101-8535, Japan



03.2026

(210) : 1904771 (151) : 24/12/2025 (511) : 5 (732) : Otsuka Pharmaceutical Co., Ltd. of 2-9 Kanda-Tsukasamachi, Chiyoda-ku Tokyo 101-8535, Japan



(210) : 1904830 (151) : 16/12/2024 (511) : 9 (732) : ADVANCED NOVA TECHNOLOGIES (SINGAPORE) HOLDING PTE. LTD. of 128 BEACH ROAD, #20-01 GUOCO MIDTOWN OFFICE SINGAPORE 189773, Singapore

# ANTOM

## 11.0 GENERAL INFORMATION

### 1. Patent, Utility Models and Industrial Design fees.

The following is a list of various fees payable under the Industrial Property Regulations, 2002

#### Patents

	Local (Kshs)	Foreign USD
Filing fee (full specification)	3, 000	150
Provisional application filing fee	1, 000	50
Substantive examination request	5, 000	250
Publication fee	3, 000	150
Grant fee	3, 000	150
Annual renewal fee -2 <sup>nd</sup> year - (varies according to years)	2, 000	300

#### Utility Models

	Local (Kshs)	Foreign USD
Filing fee (full specification)	1, 000	50
Provisional application filing fee	500	50
Publication fee	3, 000	150
Registration fee	3, 000	150
Annual renewal fee -2 <sup>nd</sup> year - (varies according to years)	1, 000	50

#### Industrial Designs

	Local (Kshs)	Foreign USD
Filing fee	3, 000	150
Publication fee	3, 000	150
Registration fee	1, 000	50
Renewal fee (after five years from application date)	10, 000	500

The complete list of fees is available on the Institute website: [www.kipi.go.ke](http://www.kipi.go.ke).

### 2. African Regional Intellectual Property Organization (ARIPO)

ARIPO is a regional body established by African governments to have a central office to among other things, process and grant industrial property rights on behalf of member states. ARIPO grants patents, utility models and industrial designs on behalf of Kenya. Currently, ARIPO consists of the following 16 member states; Botswana, Gambia, Ghana, Kenya, Lesotho, Liberia, Malawi, Mozambique, Namibia Sierra Leone, Sudan, Swaziland, Tanzania, Uganda, Zambia and Zimbabwe. Kenyan applicants are required by law to first file with the Institute before filing with ARIPO. ARIPO secretariat is located in Harare Zimbabwe.

The complete fee schedule for ARIPO is available on their website <http://www.aripo.org>. The

03.2026

following are the fees an applicant is required to pay immediately on application.

	Patents	Utility Models	Industrial Designs
Filing fee	USD 250	USD 100	USD 50
Designation fee (multiply with no. of designated countries)	USD 75	USD 20	USD 10
Transmission fee	Kshs 5000	Kshs 5000	Kshs 5000

### 3. Patent Cooperation Treaty

The Patent Cooperation Treaty (PCT) is an international patent protection treaty consisting of over 140 member states. PCT is administered by the World Intellectual Property Organization in Geneva Switzerland. PCT makes it possible for an applicant to seek patent protection for an invention simultaneously in any of the selected member states by filing one application. PCT is a filing system and does not grant patents on behalf of the member states. Applications must enter national phase in the selected member states. In the national phase, the applicant is required to pay the prescribed national fees in the said member states. Further, in some member states, a foreign applicant is required to have a resident agent. The PCT fees as of 1<sup>st</sup> May 2011 are as follows:

Type of fee	Fee	Fee waivers	
International filing fee	USD 1, 367 or CHF 1330	90% waiver for a natural person from Kenya	
Search fees  (only one search authority needs to be selected by applicant)	Austria	USD 2, 443	75% waiver for natural a person from Kenya
	Australia	USD 1, 837	None
	China	USD 314	None
	European Patent office	USD 2, 443	75% waiver for a natural person from Kenya
	Sweden	USD 2, 443	None
Transmittal fee	Kshs 5000	-	

More information is available on the PCT website [www.wipo.int/pct/en](http://www.wipo.int/pct/en)

### 4. Kenya is a signatory to the following Treaties related to industrial property rights:

No.	Treaty	Year of accession/ratification
1.	The Lusaka Agreement, establishing the African Regional Intellectual Property Organization	15 <sup>th</sup> February 1978
2.	The Protocol on Patents and Industrial Designs (Harare Protocol)	24 <sup>th</sup> October 1984
3.	The Paris Convention for Protection of Industrial Property	14 <sup>th</sup> June, 1965
4.	The World Intellectual Property Organization Convention	5 <sup>th</sup> October 1971
5.	Nairobi Treaty on the Protection of the Olympic Symbol	25 <sup>th</sup> September 1982
6.	The Patent Cooperation Treaty	8 <sup>th</sup> June 1994
7.	The Madrid Agreement Concerning the International Registration of Marks	26 <sup>th</sup> June 1998
8.	The Protocol Relating to the Madrid Agreement Concerning the International Registration of Marks	26 <sup>th</sup> June 1998

03.2026

9.	The Trade Related Aspects of Intellectual Property Rights Agreement	1 <sup>st</sup> January 1995
----	---	------------------------------

### 5. Trade Marks Forms and Fees

The following are some of the prescribed forms and the respective fees under the Trade Marks Rules:

	Description of fee	Local Fee Kshs	Foreign Fee US\$	Corresponding form
1.	Application fee for an application to register a trade mark: for the first class for each subsequent class	4, 000 3,000	200 150	TM 2
2.	Fee for registration of a trade mark under r. 60(1): for the first class for each subsequent class	2, 000 1, 500	150 100	-
3.	Fee for filing a notice of opposition to an application to register a trade mark: for the first class for each subsequent class	5000 4000	250 200	TM 6
4.	Fee for filing a counter statement: for the first class for each subsequent class	4, 000 3, 000	200 150	TM 7
5.	Fee for renewal of a registration of a trade mark under r.64(1), 67 or 68 for the first class for each subsequent class	4, 000 3, 000	200 150	TM 10
6.	Application fee for an application, under r. 71, to register an assignment or transmission, for each trade mark assigned or transmitted: for the first class for each subsequent class	3, 000 2,000	150 100	TM 14
7.	Application fee for an application, under r. 95, to register a person as a registered user of a registered trade mark, for each trade mark: for the first class for each subsequent class	6, 000 5,000	300 250	TM 48
8.	Application fee for an application, under r. 81(1), 85(2) or 101(2), to alter the trade or business address of the proprietor or a registered user, for each trade mark: for the first class for each subsequent class	2, 000 1, 000	100 50	TM 17
9.	Application fee for an application, under r. 82(1) and section 29, 30, 35 or 36 of the Act, for the making, expunging or varying of an entry in the register, for each trade mark: for the first class for each subsequent class	6, 000 5, 000	300 250	TM 25

03.2026

10.	Application fee for an application, under r. 85(2) or 101(2), to make a correction to the Register for which a fee is not otherwise specified, for each trade mark: for the first class for each subsequent class	2, 000 1, 000	150 50	TM 19
11.	Application fee for an application, under r. 85(2) or 101(2), to change the name or description of the proprietor or a registered user: for the first class for each subsequent class	3, 000 500	150 50	TM 20
12.	Fee for appointing an agent, under r. 14(2), to act in a proceeding or matter before or affecting the Registrar	1, 000	50	TM 1
13.	Application fee for an application, under r. 102, for an extension of time, other than an extension of time prescribed by rule 76: a. extension not exceeding 30 days b. extension exceeding 30 days but not exceeding 60 days c. extension exceeding 60 days	1, 000 2, 000 3, 000	50 100 150	TM 53
14.	Application fee for an application, under r. 108, to amend a document or drawing or other representation, for each trademark: for the first class for each subsequent class	2, 000 1, 000	100 50	TM 19
15.	Fee for preliminary advice of the Registrar under r. 20(1): for the first class for each subsequent class	3, 000 2, 000	150 50	TM 27

## Notes:

1. A foreign fee is payable if the person paying the fee or on whose behalf the fee is being paid does not reside in Kenya and does not have a principal place of business in Kenya.
2. All the prescribed forms and the respective fees payable for matters under the Trade Marks Act and Rules are available at [www.kipi.go.ke](http://www.kipi.go.ke)

## 6. The International Classification of Goods and Services for the Purposes of the Registration of Marks (Nice Classification)

The Nice Classification is established under the Nice Agreement Concerning the International Classification of Goods and Services for the Purposes of the Registration of Marks, one of the treaties administered by the World Intellectual Property Organization. The Nice Classification was established by an Agreement concluded at a Diplomatic Conference held in Nice on 15<sup>th</sup> June 1957. Kenya has not ratified the Agreement. However, section 6 of the Trade Marks Act provides that goods and services in respect of which registration of a mark is applied for shall be classified in accordance with the Nice Classification. The following are the class headings under the Nice Classification:

### Nice Classification (13th Edition) C L A S S H E A D I N G S

03.2026

**GOODS**

- Class 1* Chemicals for use in industry, science and photography, as well as in agriculture, horticulture and forestry; unprocessed artificial resins, unprocessed plastics; fire extinguishing and fire prevention compositions; tempering and soldering preparations; substances for tanning animal skins and hides; adhesives for use in industry; compost, manures, fertilizers; biological preparations for use in industry and science.
- Class 2* Paints, varnishes, lacquers; preservatives against rust and against deterioration of wood; colorants, dyes; inks for printing, marking and engraving; raw natural resins; metals in foil and powder form for use in painting, decorating, printing and art.
- Class 3* Non-medicated cosmetics and toiletry preparations; non-medicated dentifrices; perfumes; bleaching preparations and other substances for laundry use; cleaning, polishing and abrasive preparations.
- Class 4* Industrial oils and greases, wax; lubricants; dust absorbing, wetting and binding compositions; fuels and illuminants; candles and wicks for lighting.
- Class 5* Pharmaceuticals, medical and veterinary preparations; sanitary preparations for medical purposes; dietetic food and substances adapted for medical or veterinary purposes, food for babies; dietary supplements for human beings and animals; adhesive plasters, materials for dressings; material for filling teeth, dental wax; disinfectants; preparations for destroying vermin; fungicides, herbicide.
- Class 6* Common metals and their alloys, ores; metal materials for building and construction; transportable buildings of metal; non-electric cables and wires of common metal; small items of metal hardware; metal containers for storage or transport; safes.
- Class 7* Machines, machine tools, power-operated tools; motors and engines, except for land vehicles; machine coupling and transmission components, except for land vehicles; agricultural implements, other than hand-operated hand tools; incubators for eggs; automatic vending machines.
- Class 8* Hand-operated hand tools and implements; cutlery; side arms, except firearms; razors.
- Class 9* Scientific, research, navigation, surveying, photographic, cinematographic, audiovisual, optical, weighing, measuring, signalling, detecting, testing, inspecting, life-saving and teaching apparatus and instruments; apparatus and instruments for conducting, switching, transforming, accumulating, regulating or controlling the distribution or use of electricity; apparatus and instruments for recording, transmitting, reproducing or processing sound, images or data; recorded and downloadable multimedia files, computer software, blank digital or analogue recording and storage media; mechanisms for coin-operated apparatus; cash registers, calculating devices; computers and computer peripheral devices; diving suits, divers' masks, ear plugs for divers, nose clips for divers, gloves for divers, breathing apparatus for underwater swimming; fire-extinguishing apparatus.
- Class 10* Surgical, medical, dental and veterinary apparatus and instruments; artificial limbs, eyes and teeth; spectacles, contact lenses and sunglasses; orthopaedic articles; suture materials; therapeutic and assistive devices adapted for persons with disabilities; massage apparatus; apparatus, devices and articles for nursing infants; sexual activity apparatus, devices and articles.
- Class 11* Apparatus and installations for lighting, heating, cooling, steam generating, cooking, drying, ventilating, water supply and sanitary purposes.
- Class 12* Vehicles; apparatus for locomotion by land, air or water
- Class 13* Firearms; ammunition and projectiles; explosives; fireworks

03.2026

- Class 14* Precious metals and their alloys; jewellery, precious and semi-precious stones; horological and chronometric instruments.
- Class 15* Musical instruments; music stands and stands for musical instruments; conductors' batons.
- Class 16* Paper and cardboard; printed matter; bookbinding material; photographs; stationery and office requisites, except furniture; adhesives for stationery or household purposes; drawing materials and materials for artists; paintbrushes; instructional and teaching materials; plastic sheets, films and bags for wrapping and packaging; printers' type, printing blocks.
- Class 17* Unprocessed and semi-processed rubber, gutta-percha, gum, asbestos, mica and substitutes for all these materials; plastics and resins in extruded form for use in manufacture; packing, stopping and insulating materials; flexible pipes, tubes and hoses, not of metal.
- Class 18* Leather and imitations of leather; animal skins and hides; luggage and carrying bags; umbrellas and parasols; walking sticks; whips, harness and saddlery; collars, leashes and clothing for animals.
- Class 19* Materials, not of metal, for building and construction; rigid pipes, not of metal, for building; asphalt, pitch, tar and bitumen; transportable buildings, not of metal; monuments, not of metal.
- Class 20* Furniture, mirrors, picture frames; containers, not of metal, for storage or transport; unworked or semi-worked bone, horn, whalebone or mother-of-pearl; shells; meerschaum; yellow amber.
- Class 21* Household or kitchen utensils and containers; cookware and tableware, except forks, knives and spoons; combs and sponges; brushes, except paintbrushes; brush-making materials; articles for cleaning purposes; unworked or semi-worked glass, except building glass; glassware, porcelain and earthenware.
- Class 22* Ropes and string; nets; tents and tarpaulins; awnings of textile or synthetic materials; sails; sacks for the transport and storage of materials in bulk; padding, cushioning and stuffing materials, except of paper, cardboard, rubber or plastics; raw fibrous textile materials and substitutes therefor.
- Class 23* Yarns and threads for textile use.
- Class 24* Textiles and substitutes for textiles; household linen; curtains of textile or plastic.
- Class 25* Clothing, footwear, headwear
- Class 26* Lace and embroidery, and haberdashery ribbons and bows; buttons, hooks and eyes, pins and needles; artificial flowers; hair decorations; false hair.
- Class 27* Carpets, rugs, mats and matting, linoleum and other materials for covering existing floors; wall hangings, not of textile.
- Class 28* Games, toys and playthings; video game apparatus; gymnastic and sporting articles; decorations for Christmas trees.
- Class 29* Meat, fish, poultry and game; meat extracts for culinary purposes; preserved, frozen, dried and cooked fruits, vegetables and seaweeds; jellies, jams, compotes; eggs; milk, cheese, butter, yogurt and other milk products; oils and fats for food.
- Class 30* Coffee, tea, cocoa and substitutes therefor; rice, pasta and noodles; tapioca and sago; flour and preparations made from cereals; bread, pastries and confectionery;

03.2026

chocolate; ice cream, sorbets and other edible ices; sugar, honey, treacle; yeast, baking-powder; salt, seasonings, spices, preserved herbs; vinegar, sauces and other condiments; ice (frozen water).

*Class 31* Raw and unprocessed agricultural, aquacultural, horticultural and forestry products; raw and unprocessed grains and seeds; fresh fruits and vegetables, fresh herbs; natural plants and flowers; bulbs, seedlings and seeds for planting; live animals; foodstuffs and beverages for animals; malt.

*Class 32* Beers; non-alcoholic beverages; mineral and aerated waters; fruit beverages and fruit juices; syrups and other preparations for making non-alcoholic beverages.

*Class 33* Alcoholic beverages, except beers; alcoholic preparations for making beverages.

*Class 34* Tobacco and tobacco substitutes; cigarettes and cigars; electronic cigarettes and oral vaporizers for smokers; smokers' articles; matches.

**SERVICES**

*Class 35* Advertising; business management, organization and administration; office functions.

*Class 36* Financial, monetary and banking services; insurance services; real estate services.

*Class 37* Construction services; installation and repair services; mining extraction, oil and gas drilling.

*Class 38* Telecommunications services.

*Class 39* Transport; packaging and storage of goods; travel arrangement.

*Class 40* Treatment of materials; recycling of waste and trash; air purification and treatment of water; printing services; food and drink preservation.

*Class 41* Education; providing of training; entertainment; sporting and cultural activities.

*Class 42* Scientific and technological services and research and design relating thereto; industrial analysis, industrial research and industrial design services; quality control and authentication services; design and development of computer hardware and software.

*Class 43* Services for providing food and drink; temporary accommodation

*Class 44* Medical services; veterinary services; hygienic and beauty care for human beings or animals; agriculture, aquaculture, horticulture and forestry services.

*Class 45* Legal services; security services for the physical protection of tangible property and individuals; dating services, online social networking services; funerary services; babysitting.

-----

-

- END OF DOCUMENT

-  
-  
-  
-  
-  
-  
-