

KENYA INDUSTRIAL PROPERTY INSTITUTE



INDUSTRIAL PROPERTY JOURNAL

(Journal of Patents, Industrial Designs, Utility Models and Trade marks)

No. 2023/03

31st March, 2023

Published Monthly

EDITORIAL

The Industrial Property Journal is the Official Journal of the Kenya Industrial Property Institute. Publication of the Journal is provided for under the Industrial Property Act, 2001 and regulation 7 of the Industrial Property Regulations 2002. The Journal is published monthly by the Institute as part of the procedures for protection of industrial property rights under the Industrial Property Act, No. 3 of 2001 and the Trade Marks Act, Cap 506 of the Laws of Kenya.

.....

PUBLICATION FEES FOR MARKS

	Foreign	Local
For the first class.....	US\$ 60	Ksh. 3, 000/=
For each subsequent class.....	US\$ 50	Ksh. 2, 500/=

The above-mentioned charges apply for all other matters required to be published under the Trade Marks Act, Cap 506 of the Laws of Kenya

.....

PUBLICATION FEES FOR PATENTS, UTILITY MODELS AND INDUSTRIAL DESIGNS

Foreign	Local
US\$ 150	Ksh. 3, 000/=

The above-mentioned charges apply for all other matters required to be published under the Industrial Property Act, No. 3 of 2001

.....

Published and edited by:
Kenya Industrial Property Institute
P.O. Box 51648-00200 Nairobi.
Tel: 254-02-6002210/11, 6006326/29/36
Mobile No: 0736002020
Wireless: 0202386220
Fax: 254-02-6006312
Email: info@kipi.go.ke
Website: www.kipi.go.ke

© Kenya Industrial Property Institute 2023

The Industrial Property Journal

CONTENTS	PAGE
EDITORIAL.....	I
PUBLICATION FEES FOR MARKS.....	I
PUBLICATION FEES FOR PATENTS, UTILITY MODELS AND INDUSTRIAL DESIGNS	I
WIPO STANDARDS	IV
GENERAL NOTICES.....	V
1.0 PATENT APPLICATIONS PUBLISHED UNDER SECTION 42 AND REGULATION 35.	1
1.1 NATIONAL APPLICATION.....	1
1.2 CORRIGENDA.....	2
1.3 PCT NATIONAL PHASE APPLICATIONS.....	3
2.0 PATENTS GRANTED UNDER SECTION 45.....	3
2.1 NATIONAL PATENTS.....	3
2.2 ARIPO GRANTED PATENTS.....	6
3.0 PATENTS RENEWED UNDER SECTION 61	18
3.1 NATIONAL PATENTS.....	18
4.0 CHANGE OF ADDRESS.....	20
4.1 NATIONAL PATENT	20
5.0 UTILITY MODEL APPLICATIONS PUBLISHED UNDER SECTION 42 AND REGULATION 35	20
5.1 NATIONAL APPLICATION.....	20
6.0 UTILITY MODELS RENEWAL	22
7.0 UTILITY MODELS REGISTERED.....	23
7.1 NATIONAL UTILITY MODELS.....	23
8.0 INDUSTRIAL DESIGN APPLICATIONS PUBLISHED UNDER SECTION 87 AND REGULATION 48	26
8.1 NATIONAL APPLICATIONS	26
8.2 CORRIGENDA.....	31
8.2. ARIPO APPLICATIONS DESIGNATING KENYA.....	34
9.0 REGISTERED INDUSTRIAL DESIGNS.....	40
9.1 NATIONAL INDUSTRIAL DESIGNS.....	40
9.2 ARIPO DESIGNS.....	45
10.0 RENEWED INDUSTRIAL DESIGNS.....	52
10.1 NATIONAL DESIGNS	52
11.0 TRADE MARKS.....	52
11.1 APPLICATIONS ACCEPTED FOR REGISTRATION.....	52
11.2 CORRIGENDA	181
11.3 LICENCE.....	181
11.4 ALTERATION OF GOODS	184
11.5 SURRENDER	185
11.6 MADRID APPLICATIONS ACCEPTED FOR REGISTRATION	185
11.7 CORRIGENDA.....	217
12.0 GENERAL INFORMATION.....	219
1. PATENT, UTILITY MODELS AND INDUSTRIAL DESIGN FEES.	219
2. AFRICAN REGIONAL INTELLECTUAL PROPERTY ORGANIZATION (ARIPO)	219
3. PATENT COOPERATION TREATY	219
4. KENYA IS A SIGNATORY TO THE FOLLOWING TREATIES RELATED TO INDUSTRIAL PROPERTY RIGHTS:	220
5. TRADE MARKS FORMS AND FEES	220

6. THE INTERNATIONAL CLASSIFICATION OF GOODS AND SERVICES FOR THE PURPOSES OF THE REGISTRATION OF MARKS (NICE CLASSIFICATION).....	222
--	-----

WIPO standards**INID CODES**

INID is an acronym for 'Internationally agreed Numbers for the Identification of (bibliographic) Data'. The codes are used on the first page of industrial property documents and in gazettes to identify the bibliographic data without knowledge of the language used and the industrial property laws applied. The following INID codes are used in this Journal:

Standard ST.9 and ST.80 for Patents and utility Models and Industrial Designs

- (11) Number of the document
- (12) Designation of the kind of document
- (15) Correction information
- (19) WIPO standard ST.3 code of the office or organization publishing the document
- (21) Application Number
- (22) Date of filing of application
- (30) Priority data
- (31) Priority Number(s).
- (32) Priority Date(s).
- (33) Priority Country(s).
- (41) Publication date of unexamined application
- (42) Publication date of examined application
- (45) Publication date of registered right/Date of registration
- (51) International classification.
- (54) Title of the Invention.
- (56) Cited documents
- (57) Abstract
- (71) Name(s) of applicant(s)
- (72) Name(s) of Inventor(s)
- (730) Proprietor
- (740) Name and address of Agent or address for service
- (85) Date of entry into national phase for PCT applications
- (87) PCT Publication data
- Standard ST. 60 for Marks
- 111 Registration number
- 180 Expiry Date
- 210 Application number
- 220 Filing date of application
- 300 Data relating to Application under the Paris convention
- 442 Date of advertisement
- 511 International classification and/or list of goods and services
- 526 Disclaimer
- 540 Reproduction of the Mark
- 566 Translation of the mark or words contained in the mark
- 15 Amendment/Correction information
- 591 Information concerning colours claimed
- 730 Name and address of the/proprietor
- 740 Name and address of the agent or applicant
- 791 Name and address of Licensee/registered user

GENERAL NOTICES

1.0 Patent Applications published under Section 42 and Regulation 35.

1.1 National Application

(21) Application no.: KE/P/2020/3772 (22) Filing Date: 21/12/2020

(51) Int.Cl.

(54) Title: METHOD AND SYSTEM FOR REMOTE MANAGEMENT OF ACCESS TO APPLIANCES

(72) Inventors: DOUGLAS JAMES RICKET and JAIDEEP MIRCHANDANI

(73) Applicant(s): PAYJOY INC 655 4TH STREET, SAN FRANCISCO, CALIFORNIA, 94107, U.S.A.

(74) Agent: J.K MUCHAE & COMPANY ADVOCATES, P.O BOX 60664- 00200, NAIROBI, Kenya

(57) Embodiments described herein include methods and systems for remotely managing appliances, including enabling communication between a user of the appliance and third party systems. The third party systems include any entity that has a relationship with the user of the appliance, such as a payment infrastructure handling incremental payments for the appliance, and managing access to the appliance accordingly. In some embodiments, the appliance being controlled is a mobile phone that also includes third party operating system software. Various methods for preventing alteration or replacement of the third party operating system are also described.

.....
(21) Application no.: KE/P/2022/4225 (22) Filing Date: 27/04/2022

(51) Int.Cl.

(54) Title: NAJA ASHEI VENOM ANTI-THREE FINGER TOXINS (3FTXS) MONOCLONAL ANTIBODIES

(72) Inventors: ERNEST ZIEM MANSON; JOSEPHINE KIMANI; MUTINDA C. KYAMA; JAMES H. KIMOTHO and JOSEPH K. GIKUNJU

(73) Applicant(s): JOMO KENYATTA UNIVERSITY OF AGRICULTURE AND TECHNOLOGY (JKUAT) PAN AFRICAN UNIVERSITY INSTITUTE OF BASIC SCIENCES TECHNOLOGY AND INNOVATION (PAUSTI), P.O BOX 62000-00200, NAIROBI, KENYA

(74) Agent: DIRECTORATE OF INTELLECTUAL PROPERTY MANAGEMENT AND UNIVERSITY- INDUSTRY LIASON, JKUAT, P.O BOX 62000-00200, NAIROBI, KENYA

P.O BOX 62000-00200, NAIROBI, KENYA

(57)

The invention relates to *N ashei* venom anti-3FTxs mono clonal antibodies with demonstrated *in vitro* inhibition activity against crude *N ashei* venom. Provided are mice m.Abs that target and bind to cytotoxic 3FTxs proteins present in the venom of *N ashei*, wherein the antibodies are:

- a) anti-3FTxs mono clonal or b) whole antibodies, IgG or antigen-binding fragments thereof or c) engineered into chimeric, humanized or fully human antibodies utilizing anti-3FTxs mAbs or d) generated from the fusion of mouse splenocytes and myeloma cells to form hybridoma cell lines or e) produced *in vitro* by culturing the anti-3FTxs hybridoma cell lines or *in vivo* using rodents to obtain ascites or f) used for producing a pharmaceutical product comprising antibodies which target and bind to 3FTxs in *N ashei* and other spitting cobra venoms or g) used for a pharmaceutical composition wherein the toxin is 3FTxs from *Naja ashei* or other spitting cobra venoms.

.....
(21) Application no.: KE/P/2022/4281 (22) Filing Date: 03/06/2022

(30) Priority: 202121024728 03/06/2021 IN

(51) Int.Cl.2016.01 B 05B 11/00, A 61M 5/50, B 65D 41/34

(54) Title: TAMPER-EVIDENT CLOSURE FOR A RECEPTACLE

(72) Inventors: SANJAY KUMAR SINGH

(73) Applicant(s): VFORM TECHNOPACK PRIVATE LIMITED, FLAT NO-C-34, THIRD FLOOR PURVANCHAL CHS, PLOT NO. 1E, SECTOR-1 AIROLI NAVI MUMBAI, THANE MAHARASHTRA- 400708, India

(74) Agent: COULSON HARNEY LLP, P.O. Box 10643-00100, Nairobi, Kenya

(57) A tamper-evident closure for a receptacle, the tamper-evident closure including a cap (10), adapted to close a mouth (2) of the receptacle, and a capsule (20) with a lower portion (21) with coupling configurations adapted to retain the lower portion around the cylindrical neck (1) of the container and an upper portion (22) surrounding the cap (10), preventing the opening thereof, the upper portion (22) being or including a capsule tear-off seal detachable from the lower portion (21) by breakage, the capsule tear-off seal including a gripping

tab (23); wherein the cap (10) includes a cap twist-off seal (11) including anti-rotational coupling configurations (12) adapted to be attached to the cylindrical neck (1) and adapted to urge the cap twist-off seal (11), or portions thereof, outwards in a radial direction when the cap (10) is rotated in regard to the cylindrical neck (1) producing a break of the twist-off seal (11).

.....

(21) Application no.: KE/P/2022/4331 (22) Filing Date: 09/09/2022

(51) Int.Cl.2016.01 G 08B 21/00, A 61B 5/00

(54) Title: SMART PATIENT MONITOR

(72) Inventors: JANET KAMENE MAKAU; IMMACULATE MATETE and DAVID OCHIENG

(73) Applicant(s): KABETE NATIONAL POLYTECHNIC, JANET KAMENE MAKAU, IMMACULATE MATETE P. O. BOX 29010-00625 NAIROBI, Kenya

(57)

The system continuously monitors the patient's body parameters, displays them on screen and regularly update the data on the doctor's mobile phone in real time. This will ensure that the doctor has maximum update and monitoring of the patient's conditions in real time while attending to other duties. This will save medical staff the time they take to frequently get into the ICU or HDU to check on the patient's conditions as it is the case with the current machines. The system will also be able to sound an alarm if any or all the patient's conditions are not optimum. Multiple technologies (SMS, Bluetooth, Wi-Fi) will be utilized in data transmission to the doctor to avoid communication failure. Biometric Access Control and RFID technology will be utilized to ensure the security of the system, only allowed medical staff will be able to operate and change the parameters of the machine through its HMI. The staff will use their RFID cards to identify themselves and then present their fingerprints to prove that they are who they claim to be before the system turns on for them to be able to use it on patients.

.....

(21) Application no.: KE/P/2022/004371 (22) Filing Date: 28/11/2022

(51) Int.Cl.2016.01: A 01K 27/00, A 01N 25/10

(54) Title: CONTINUOUS RELEASE FLEA AND TICK COLLAR

(72) Inventors: HAPI TELI MVOO, P. O. BOX 114-00618 RUARAKA

(73) Applicant(s): HAPI TELI MVOO, P. O. BOX 114-00618 RUARAKA

(57) A continuous release plastic polymer matrix formulation (PPMF-CR) polyethylene-comprising polymer, a plasticizer and at least one insecticide as active component is described. The PPMF-CR may be used in the manufacture of wearable device for treating ecto-parasitic infections.

.....

(21) Application no.: KE/P/2023/4408 (22) Filing Date: 23/02/2023

(30) Priority: 2023/4399 06/02/2023 KE

(51) Int.Cl.2018.01 G 06Q 20/00

(54) Title: SYSTEM AND PROCESS FOR MICRO - FUNDRAISING BY UTILIZING FLASH MESSAGES AS CALL PLEDGE BADGES

(72) Inventors: SAM MUTUURA

(73) Applicant(s): CROSS GATE SOLUTIONS LIMITED, P.O. BOX 175-00606 NAIROBI, Kenya

(57) The present invention discloses a computer-operated system and process for micro-fundraising by utilizing flash messages as call pledge badges using calling airtime of mobile hand-held devices. The system comprises a funds drive registry, user's subscription module via USSD to the service, an activation module, a means of donation and public portal. The said system comprises an incoming call pledge badge, out-going call pledge badge, memory and service activation flow through a website, USSD Code and Short Code. The said call pledge badge legs are set by customer/person according to preference. When customer/person A calls person B and if person B is available, then person A receives a class 0 message set by person B on call termination designed to facilitate donations for emergency, educational, medical and social needs such as drought, hunger or epidemics.

.....

1.2 Corrigenda

The image of the patent application to appear as below;

(21) Application no.: KE/P/2022/4389 (22) Filing Date: 20/12/2022

(30) Priority: 2022/4340 27/09/2022 KE

(51) Int.Cl.2016.01 F 24C 3/08

(54) Title: FIRE CHAMBER COOK STOVE

(72) Inventors: ISAAC KIRAGU W, P.O. BOX 1416-00200 NAIROBI, Kenya
(73) Applicant(s): SUNVINE AFRICA LIMITED, P.O. BOX 1416-00200 NAIROBI, Kenya
(74) Agent: FRED OTSWONG'O, INTELLECTUAL PROPERTY ASSOCIATES, P. O. BOX 54708-00200 NAIROBI, KENYA
(57)

Disclosed in the invention is a steel and ceramic fire chamber cook stove 100, comprising a ceramic combustion chamber 13, three support stands 1, stainless wire mesh 6, a frame, outer body cover 2, air inlet door 5, bottom lid 10 at the base and other members. The combustion chamber outer cover 2 is attached to the top lid 4 and bottom lid 10. The top lid is manufactured from stainless steel or cast iron. On the surface of the cover, are placed sturdy ergo designed four pot support holders 3 to increase stability while cooking. The distance between the pot and the flame from the cook stove is designed to allow effective heat transfer to avoid wastage. The cast iron cover assumes a dark colour finished to suit different cook stove fuel using charcoal, wood, briquette.

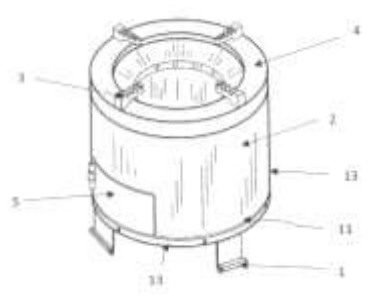

.....

1.3 PCT National Phase Applications

(21) KE/23/04414 (PCT/CN2021/114718)
(22) 26/08/2021
(54) TAMPING DEVICE AND TAMPING MACHINE
(71) CRCC HIGH-TECH EQUIPMENT CORPORATION LIMITED
(85) 09/03/2023
.....

(22) 14/09/2021
(54) A METHOD OF PROCESSING TOBACCO FINES INTO A NON-CONTINUOUS TOBACCO MATERIAL
(71) BRITISH AMERICAN TOBACCO EXPORTS LIMITED
(85) 14/03/2023
.....

(21) KE/23/04419 (PCT/GB2021/052504)
(22) 24/09/2021
(54) A GAS METER FOR A BIOGAS DIGESTER
(71) INCLUSIVE ENERGY LTD
(85) 10/03/2023
.....

(21) KE/23/04425 (PCT/BR2021/050397)
(22) 17/09/2021
(54) SEALING SYSTEM WITH AUTOMATIC COMPENSATION FOR THERMAL EXPANSION FOR A ROTARY CYLINDRICAL REACTOR
(71) TECNORED DESENVOLVIMENTO TECNOLOGICO S.A.
(85) 20/03/2023
.....

(21) KE/23/04421 (PCT/GB2021/052379)

2.0 Patents Granted under Section 45

2.1 National Patents

(11) Patent Number: KE 959 date of grant: 01/03/2023
(21) Application Number: KE/P/2022/4353 (22) Filing Date:18/11/2022
(73) Owner(s): DARYA AFRICA INVESTMENTS LIMITED of P. O. BOX 49670-00100 NAIROBI, Kenya
(72) Inventor(s) JOHN MUNGAI, P. O. BOX 49670-00100 NAIROBI, Kenya
(74) Agent/address for correspondence: NGERI, OMITI & BUSH ADVOCATES LLP, P. O BOX 12263-00100, Nairobi, Kenya
(54) Title: AN APPLICATION AND SYSTEM FOR PROVIDING CASH ADVANCES
(51) Int.Cl.2016.01: G 06F 17/00, G 07F 7/08, G 07F 19/00
(57) Abstract:

The present invention relates generally to a system that allows a customer to get cash when paying their bills and more specifically to a system and method for providing cash advances. The invention discloses a system that allows a customer to get cash when paying their bills and more specifically to a system and method for providing cash advances comprising of:- A Mini App that allows the client to input the till, the bill amount and

cash to withdraw; A cloud application hosted on AWS that processes the requests and sends a message to the merchant requesting them to give funds to the customer and also does the commission sharing; An ERP that allows real time reporting and A USSD Application that serves customers with feature phones. It is in this invention that the cloud application is further divided to: A queueing service that queues and processes the call back notifications from the service providers; A C2B service that handles C2B call backs and inserts them to a database for the ERP System; A B2B Service that automates the splitting of partner commissions and saves the records on a DB for the ERP System and report generation; Database to hold C2B and the B2B records and A web ERP application for report generation and settlement

.....

(11): KE 960 (45): 06/03/2023 (21):2018/2790 (22):10/10/2016 (30):15189033.2 08/10/2015 EP
(73): SICPA HOLDING SA of Avenue de Florissant 41 1008 Prilly, Switzerland
(72): DUCA, Nicola and BOULLE, Alexandre (74): Kaplan & Stratton Advocates, P.O. BOX 40111-00100 Nairobi, Kenya
(54): SECURE DELIVERY SYSTEM, LOGGING MODULE AND ACCESS CONTROLLED CONTAINER
(51) Int.Cl.2016.01: G 06Q 10/08, G 06Q 30/00, F 16K 35/02, B 41J 2/17
(57): A logging module for identifying a suspected tampering condition of an access-controlled container, the logging module comprising : data collection means configured to collect data from said access-controlled container; and communication means for communicatively connecting the logging module across a network to a database storing a use history associated with said access-controlled container; wherein the logging module is configured to compare the collected data to the corresponding use history associated with said access - controlled container stored in the database to identify a suspected tampering condition of said access - controlled container, wherein the use history comprises data associated with the weight and/or volume of content of the access -controlled container.

.....

(11): KE 961 (45): 08/03/2023 (21):2016/2445 (22):15/07/2011 (30):2013/1739 16/01/2013 KE; 10-2010-0097424 06/10/2010 KR and 61/364,986 16/07/2010 US
(73): SAMSUNG ELECTRONICS CO., LIMITED of 129, Samsung-Ro Yeongtong-gu, Suwon-si Gyeonggi-Do 443-742, Rep. of Korea
(72): HAN, Woo-Jin; MIN, Jung-Hye and LEE, Sun-Il
(74): Hamilton Harrison & Mathews, P.O. Box 30333 - 00100, Nairobi, Kenya
(54): METHOD AND APPARATUS FOR ENCODING AND DECODING IMAGE THROUGH INTRA PREDICTION
(51) Int.Cl.2016.01: H 04N 7/34, H 04N 7/32
(57): A method and apparatus for encoding and decoding an image through intra prediction using a pixel of the neighboring block along an extended line having a predetermined gradient about a pixel inside the current block.

.....

(11): KE 962 (45): 08/03/2023 (21):2016/2464 (22):15/07/2011 (30):2016/002445 06/04/2016 KE; 10-2010-0097424 06/10/2010 KR and 61/364,986 16/07/2010 US
(73): SAMSUNG ELECTRONICS CO., LIMITED of 129, Samsung-Ro Yeongtong-Gu, Suwon-Si Gyeonggi-Do 443-742, Rep. of Korea
(72): HAN, Woo-Jin; MIN, Jung-Hye and LEE, Sun-Il
(74): Hamilton Harrison & Mathews Advocates P.O. Box 30333-00100, Nairobi, Kenya
(54): METHOD AND APPARATUS FOR ENCODING AND DECODING IMAGE THROUGH INTRA PREDICTION
(51) Int.Cl.2016.01: H 04N 7/34, H 04N 7/32
(57): A method and apparatus for encoding and decoding an image through intra prediction using a pixel of the neighboring block along an extended line having a predetermined gradient about a pixel inside the current block.

.....

(11): KE 963 (45): 17/03/2023 (21):2018/2957 (22):30/11/2016 (30):15201660.6 21/12/2015 EP
(73): UNILEVER PLC of Unilever House, 100 Victoria Embankment London, Greater London EC4Y 0DY, United Kingdom
(72): DONSI, Francesco; VELIKOV, Krassimir, Petkov; VOUDOURIS, Panayiotis and JANSEN, Jeffrey, Nikolai
(74): Kaplan & Stratton Advocates, P. O. Box 40111-00100 Nairobi, Kenya
(54): IRON-FORTIFIED SAVOURY CONCENTRATE
(51) Int.Cl.2016.01: A 23L 33/10
(57):
The present invention relates to a savoury concentrate containing: • 30-80 wt.% of salt particles, including at least 0.002 wt.% of iron-containing salt particles comprising: 0.03-30 mol% of iron cation selected from Fe²⁺,

Fe³⁺ and combinations thereof; 10-49.97 mol% of non-iron cations selected from Na⁺, K⁺, Ca²⁺, NH₄⁺ and combinations thereof; 16-70.2 mol% of Cl⁻; 0-30 mol% of anions selected from SO₄²⁻, citrate, fumarate and combinations thereof; • at least 3 wt.% of taste imparting components selected from glutamate, sugars, pieces of plant material and combinations thereof; 0-30 wt.% of oil; • 0-10 wt.% water. The savoury concentrate of the present invention offers the advantage that the iron contained therein is highly bioavailable. Furthermore, the iron-containing salt particles contained in the savoury concentrate do not give rise to unacceptable colour changes.

.....

(11): KE 964 (45): 17/03/2023 (21):2016/2466 (22):15/07/2011 (30):2016/002445 06/04/2016 KE; 10-2010-0097424 06/10/2010 KR and 61/364,986 16/07/2010 US

(73): SAMSUNG ELECTRONICS CO., LIMITED of 129, Samsung-Ro Yeongtong-Gu, Suwon-si Gyeonggi-Do 443-742, Rep. of Korea

(72): HAN, Woo-Jin; MIN, Jung-Hye and LEE, Sun-Il

(74): Hamilton Harrison & Mathews Advocates, P.O. Box 30333-00100, Nairobi, Kenya

(54): METHOD AND APPARATUS FOR ENCODING AND DECODING IMAGE THROUGH INTRA PREDICTION

(51) Int.Cl.2016.01: H 04N 7/34, H 04N 7/32

(57): A method and apparatus for encoding and decoding an image through intra prediction using a pixel of the neighboring block along an extended line having a predetermined gradient about a pixel inside the current block.

.....

(11): KE 965 (45): 23/03/2023 (21):2017/2669 (22):01/06/2015 (30):

(73): GUANGDONG OPPO MOBILE TELECOMMUNICATIONS CORP., LTD. of No.18, Haibin Road, Wusha, Chang'an Dongguan, Guangdong 523860, China

(72): ZHANG, Jialiang

(74): SIMBA & SIMBA ADVOCATES, P.O. BOX 10312-00100, NAIROBI, Kenya

(54): CHARGING CIRCUIT AND MOBILE TERMINAL

(51) Int.Cl.2016.01: H 02J 7/00

(57): A charging circuit and a mobile terminal, the charging circuit (30) being arranged between a charging interface (10) and a battery (20) of the mobile terminal, the charging circuit comprising: a first circuit (31), a capacitive coupling element (33) and a second circuit (32) which are sequentially connected in series between the charging interface and the battery, the capacitive coupling element breaking a direct current path of the charging circuit. A direct current path of the charging circuit is separated by the capacitive coupling element. In other words, a direct current path is not present on the charging circuit, so that when the first circuit fails, direct current outputted by the charging interface is not directly outputted to the second circuit and the battery, thereby improving the reliability of the charging circuit.

.....

(11): KE 966 (45): 29/03/2023 (21):2016/2531 (22):23/01/2015

(30):325/CHE/2014 27/01/2014 IN

(73): PRAHARAJU LAXMIHARAYANA of 35E, Phase V, IDA Cherlapally Hyderabad - 500 051, India

(72): Ajay Kumar Singh

(74): SIMBA & SIMBA ADVOCATES, REET, P.O. BOX 10312-00100, NAIROBI, Kenya

(54): MYCOHERBICIDAL COMPOSITION FOR CONTROLLING LANTANA CAMARA WEED

(51) Int.Cl.2016.01: A 01N 63/04

(57): The invention relates to describe host-specific extracellular phytotoxins produced by Fusarium sp. That has a phytotoxic to Lantana camara. A novel method using phytotoxin has been developed for controlling Lantana camara, these phytotoxin can be used partially pure, as a cell- and spore-free filtrate, a crude filtrate, or a crude suspension of the culture and optionally along with other additives. 18s rRNA sequence analysis showed 93% nucleotide similarity of the Fungi to Fusarium sp. But also indicated nucleotide variation of this fungus from other known genus of Nectaria, Mariannaea, Volutella, Myrothecium. This analysis suggested that the novel fungus is closest to Fusarium sp. It is proposed that this is a new species of Fusarium sp.

.....

(11) Patent Number: KE 967 date of grant: 31/03/2023

(21) Application Number: KE/P/2018/3044 (22) Filing Date:15/03/2019

(73) Owner(s): ABDULKADIR AHMAD MOHAMED of P.O. BOX 197-80500 LAMU, Kenya

(72) Inventor(s) ABDULKADIR AHMAD MOHAMED, P.O. BOX 197-80500 LAMU, Kenya

(74) Agent/address for correspondence: ABDALLAH SALIM BUSAID, P.O. BOX 20140-00100 NAIROBI, Kenya

(54) Title: PORTABLE LIQUID DISPENSER AND MEASURER

(51) Int.Cl.2018.01: G 01F 15/00, G 01F 25/00, G 01F 3/00, B 05B 11/00, A 47J 31/00

(57) Abstract: The invention relates to a portable liquid dispenser for dispensing preselected quantities of liquid on demand from a liquid receptacle comprising a housing containing a pump driven response to motor activation signals received from a microcontroller, a microcontroller, a battery and a flow control handle at which the desired quantity of liquid to be delivered can be dispersed through. The pump is connected by way of flexible liquid dispensing tubes connected to the respective liquid inlet and liquid outlet ports of the pump. A filter is connected to the liquid inlet tube while the liquid outlet tube is connected to a flow control handle containing a flow sensor, solenoid valve and spout nozzle. The flow sensor pulses when liquid flows through it, for the microcontroller to process into volumes of liquid. The microcontroller calculates the cumulative volume of liquid dispensed and produces a signal for closing of the solenoid valve when the preselected quantity has been dispensed

.....

2.2 ARIPO granted Patents

(11) Patent Number: 5469 date of grant: 15/02/2021

(21) Application Number: 2017/9975 (22) Filing Date: 07/12/2015

(30) Priority:14196954.3 09/12/2014 EP

(73) Owner(s): BAYER AKTIENGESELLSCHAFT of Kaiser-Wilhelm-Allee 1, 51373 Leverkusen, Germany

(72) Inventor(s)

(74) Agent/Address for service: ADAMS AND ADAMS MOZAMBIQUE, Rua Estevão Ata-de, #20, R/C Bairro da Sommerschild, Maputo, Mozambique

(54) Title: 1,3-THIAZOL-2-YL SUBSTITUTED BENZAMIDES

(51) Int.Cl.: C 07D 417/12, C 07D 417/14, A 61K 31/497, A 61K 31/4439, A 61K 31/501, A 61K 31/506, A 61K 31/433, A 61P 31/18, A 61P 29/00, A 61P 25/16, A 61P 13/00

(57) Abstract: The present invention relates to 1,3-thiazol-2-yl substituted benzamide compounds of general formula (I) as de - scribed and defined herein, to pharmaceutical compositions and combinations comprising said compounds and to the use of said compounds for manufacturing a pharmaceutical composition for the treatment or prophylaxis of a disease, in particular of neurogenic disorder, as a sole agent or in combination with other active ingredients.

.....

(11) Patent Number: 6290 date of grant: 16/06/2022

(21) Application Number: 2019/11827 (22) Filing Date: 03/02/2018

(30) Priority:201741004017 03/02/2017 IN

(73) Owner(s): HLL LIFECARE LIMITED of HLL Bhavan, Mahilamandiram Road, Poojappura, Thiruvananthapuram, Kerala 695 012, India and NATIONAL INSTITUTE OF IMMUNOLOGY of Aruna Asaf Ali Marg, New Delhi, 110067, India

(72) Inventor(s)

(74) Agent/Address for service: ROLAND INTELLECTUAL PROPERTY CONSULTANTS, 3 Maritz Street, Windhoek, P. O. Box 91198, WINDHOEK, Namibia

(54) Title: HERBAL MICROBICIDE FORMULATION FOR PREVENTING HIV

(51) Int.Cl.: A 61K 36/185, A 61K 36/47, A 61K 36/48, A 61K 36/75, A 61K 9/00, A 61P 31/18

(57) Abstract: The present invention relates to an aqueous gel formulation and its method of preparation using combination of four or five medicinal plants for preventing sexually transmitted HIV-1. The gel formulation comprises 50% aqueous ethanolic extracts of medicinal plants namely Terminalia chebula, Phyllanthus emblica, Lagerstroemia speciosa, Acacia catechu and/or Aegle marmelos. The invention provides an herbal formulation useful as a vaginal/rectal microbicide gel. These herbal formulations showed potent in vitro anti-HIV-1 activity using reporter-gene based cell lines (TZM-bl) as well as human peripheral blood lymphocytes. These formulations also inhibited HIV-1 reverse transcriptase, integrase and protease activities suggesting that these may be working at multiple steps/stages of HIV life cycle and thus may be a valuable tool for alternative therapy.

.....

(11) Patent Number: 6291 date of grant: 16/06/2022

(21) Application Number: 2019/11902 (22) Filing Date: 05/04/2018

(30) Priority:62/482,175 05/04/2017 US

(73) Owner(s): BOEHRINGER INGELHEIM ANIMAL HEALTH USA INC. of 3239 Satellite Blvd., Duluth, Georgia, 30096, United States of America

(72) Inventor(s)

(74) Agent/Address for service: Cronjão & Co., 1 Charles Cathral Street, Olympia, Windhoek, Namibia

(54) Title: CRYSTALLINE FORMS OF (S)-AFOXOLANER

(51) Int.Cl.: C 07D 261/04, A 61K 31/42, A 61P 33/00

(57) Abstract: The present invention provides crystalline forms of compound of formula (Ia) and processes of making the crystalline forms. Also provided are compositions comprising the crystalline forms and crystalline forms for treating or preventing parasitic infections in an animal.

.....
(11) Patent Number: 6292 date of grant: 16/06/2022

(21) Application Number: 2019/12106 (22) Filing Date: 28/06/2018

(30) Priority:201821014426 IN; 15/716,661 US and 15/903,597 US

(73) Owner(s): Glenmark Specialty S.A. of Avenue LÄ©opold-Robert 37 2300 La Chaux-De-Fonds, Switzerland

(72) Inventor(s)

(74) Agent/Address for service: FISHER CORMACK & BOTHA, P.O. Box 74 Blantyre MALAWI

(54) Title: DISPENSING DEVICE AND PHARMACEUTICAL COMPOSITION FOR THE TREATMENT OF RHINITIS

(51) Int.Cl.: B 05B 11/00, A 61K 47/02, A 61K 9/00, A 61M 15/08, A 61M 11/00

(57) Abstract: A nasal dispensing device and pharmaceutical composition includes a container; a dispenser head having at least a pump, a dispensing channel, and a dispensing orifice; a dip tube; and a pharmaceutical composition comprising mometasone, an ester thereof (e.g., mometasone furoate), or a salt thereof and olopatadine or its salt (e.g., olopatadine hydrochloride). The container can have a conically shaped internal bottom, angled downwardly toward a center, and a further angularly deepened well, centrally located, with the dip tube extending into the well. An optional cap is provided that includes a sealing sleeve communicating in a seal tight manner with a perimeter of a lateral wall of the dispenser head.

.....
(11) Patent Number: 6486 date of grant: 14/10/2022

(21) Application Number: 2018/11089 (22) Filing Date: 12/04/2017

(30) Priority:EP16165075.9 13/04/2016 EP and 2016/02520 13/04/2016 ZA

(73) Owner(s): DUPONT NUTRITION BIOSCIENCES APS of Langebrogade 1 1411 Copenhagen K, Denmark

(72) Inventor(s)

(74) Agent/Address for service: FISHER CORMACK & BOTHA, P O Box 74, Blantyre, MALAWI

(54) Title: MANUFACTURE OF A CEREAL-BASED LACTIC ACID-FERMENTED PRODUCT

(51) Int.Cl.: A 23C 11/10, A 23L 7/104, A 23L 2/38

(57) Abstract: The present invention relates to a culture or kit-of-part comprising a Lactobacillus delbrueckii subsp lactis strain, and uses thereof to manufacture a cereal-based lactic acidfermented product, in particular a maize-based lactic acid-fermented product such as mahewu.

.....
(11) Patent Number: 6502 date of grant: 19/10/2022

(21) Application Number: 2020/12191 (22) Filing Date: 12/06/2018

(30) Priority:102017000074290 03/07/2017 IT

(73) Owner(s): I.V.A.R. S.P.A. of Via IV Novembre, 181, 25080 Prevalle (bS), Italy

(72) Inventor(s)

(74) Agent/Address for service: FISHER CORMACK & BOTHA, P. O. Box 74, Blantyre, MALAWI

(54) Title: HEAT MACHINE CONFIGURED FOR REALIZING HEAT CYCLES AND METHOD FOR REALIZING HEAT CYCLES BY MEANS OF SUCH HEAT MACHINE

(51) Int.Cl.: F 01C 1/077, F 01C 1/18, F 01K 13/00, F 01K 7/36

(57) Abstract: A heat machine (121) for realizing a heat cycle, the heat machine operating with a thermal fluid and comprising a drive unit (1) provided with a first rotor (4) and a second rotor (5), each having three pistons (7a, 7b,7c; 9a,9b,9c) that are slidable in an annular chamber (12), wherein the pistons delimit six variable-volume chambers (13', 13", 13""; 14', 14", 14""). The drive unit comprises a transmission configured to convert the rotary motion with respective first and second periodically variable angular velocities (İ%1, İ%2) of said first and second rotor (4, 5), offset from each other, into a rotary motion at a constant angular velocity. The heat machine further comprises a compensation tank (44), configured to accumulate the compressed thermal fluid from the drive unit, a regenerator (42) configured to preheat the thermal fluid, a heater (41) configured to superheat the thermal fluid circulating in the serpentine coil, a burner (40), configured to supply the necessary thermal energy to the heater (41); wherein the regenerator (42), in fluid communication with the drive unit (1), is further configured to acquire energy-heat from the exhausted thermal fluid and use it to preheat the thermal fluid to be sent to the heater (41). The invention further relates to a method for realizing a heat cycle by means of said heat machine.

.....
(11) Patent Number: 6577 date of grant: 06/12/2022

(21) Application Number: 2019/11871 (22) Filing Date: 21/03/2018

(30) Priority:1704738.2 24/03/2017 GB
(73) Owner(s): POWER ROLL LIMITED of Washington Business Centre, 2 Turbine Way, Sunderland, SR5 3NZ , United Kingdom
(72) Inventor(s)
(74) Agent/Address for service: FISHER CORMACK & BOTHA, P. O. Box 74 Blantyre MALAWI
(54) Title: OPTOELECTRONIC DEVICE WITH REFLECTIVE FACE
(51) Int.Cl.: H 01G 11/00, H 01G 9/00, H 01L 31/053, H 01L 31/0236, H 01L 31/056, H 01L 31/0224
(57) Abstract: The present invention relates to an optoelectronic device comprising a substrate having a first and a second substantially planar face, a series of grooves in the first substantially planar face, and a first and a second electrical conductor on the second substantially planar face; wherein a first face of the first electrical conductor and a first face of the second electrical conductor are reflective.

.....

(11) Patent Number: 6578 date of grant: 06/12/2022
(21) Application Number: 2020/12481 (22) Filing Date: 27/11/2018
(30) Priority:1719688.2 27/11/2017 GB
(73) Owner(s): PYROGENESYS LIMITED of Faraday Wharf Holt Street Birmingham West Midlands B7 4BB, United Kingdom
(72) Inventor(s)
(74) Agent/Address for service: FISHER CORMACK & BOTHA, P. O. Box 74, Blantyre, Malawi
(54) Title: PYROLYSIS REACTOR AND METHOD OF PYROLYZING BIOMASS WASTE RESIDUE
(51) Int.Cl.: C 10B 53/02, C 10B 47/44
(57) Abstract: A pyrolysis reactor(10)having an inlet for material (42) and an outlet for products(43), the reactor comprising a screw (1) for conveying biomass waste from the inlet to the outlet, the screw (1) comprising a shaft (2) with a first end and a second end adjacent the outlet and a helical flight (3) arranged about the shaft and extending between the first and second ends, wherein the pitch of the flight (3) alters between the first and second ends of the shaft, the screw (1) having a heater extending from the first end to the second end.

.....

(11) Patent Number: 6579 date of grant: 06/12/2022
(21) Application Number: 2020/12721 (22) Filing Date: 16/04/2019
(30) Priority:00493/18 17/04/2018 CH
(73) Owner(s): UHCS PROPERTY SA of c/o Fondation The Ark Rue de l'Industrie 17, 1950 Sion, Switzerland
(72) Inventor(s)
(74) Agent/Address for service: FISHER CORMACK & BOTHA, P. O. Box 74, Blantyre, Malawi
(54) Title: CONSTRUCTION SYSTEM FOR A MODULE OF A BUILDING
(51) Int.Cl.: E 04B 1/343, E 04B 1/58, E 04C 3/04
(57) Abstract: The invention proposes a system for constructing a module of a building, including core construction elements (1) that are surrounded by the surrounding construction elements (2A, 2B). The core construction elements (1) each include, in section, a cross including two main arms (6) of equal length which intersect at midlength at right angle. Each core construction element (1) has a plane of symmetry about the axes of the arms. The main arms (6) of the cross terminate, at the ends thereof, with transverse portions (7). Each surrounding construction element (2A, 2B) is composed of four partial surrounding parts (2A, 2B, 2Aâ€™™, 2Bâ€™™) of a generally triangular shape which are assembled around a core element (1). Construction elements forming junction parts (4A, 4B) allow assembling panels (4A, 4B) to form a module of a building in the form of a rectangular parallelepiped volume comprising four corners.

.....

(11) Patent Number: 6581 date of grant: 07/12/2022
(21) Application Number: 2019/11299 (22) Filing Date: 21/06/2017
(30) Priority:16175687.9 22/06/2016 EP
(73) Owner(s): UWATER Oy of KaskimÄ±enkatu 2 33900 Tampere, Finland
(72) Inventor(s)
(74) Agent/Address for service: ENSafrica Namibia, Private Bag 12007, Ausspannplatz, Windhoek, Namibia
(54) Title: DETECTING MICROSCOPIC OBJECTS IN FLUIDS
(51) Int.Cl.: G 01N 15/02, G 01N 15/10, G 01N 21/85, G 03H 1/00, G 06T 7/10
(57) Abstract: A method (10) comprises: obtaining (11) prepared image data captured by an image sensor receiving light propagated across a sample volume, containing a fluid possibly comprising microscopic objects of foreign origin, while illuminating the sample volume by coherent light, the prepared image data comprising, for a microscopic object, a prepared hologram pattern with prepared spatially alternating intensity formed by interference fringes; providing (12) filtered image data, comprising automatically filtering the prepared image

data by an edge enhancing filter, the filtered image data comprising, for a prepared hologram pattern, a filtered hologram pattern; and automatically detecting (13), on the basis of the filtered hologram pattern, the presence of the microscopic object associated with the filtered hologram pattern in the sample volume of the fluid.

.....

(11) Patent Number: 6585 date of grant: 09/12/2022
(21) Application Number: 2019/11526 (22) Filing Date: 03/11/2017
(30) Priority:1618635.5 04/11/2016 GB
(73) Owner(s): The Governors Of The University Of Alberta of #4000 10230 Jasper Avenue Edmonton, Alberta T5J 4P6, Canada and The Secretary Of State For Environment, Food And Rural Affairs of Acting through the Animal and Plant Health Agency Woodham Lane Addlestone Surrey KT15 3NB, United Kingdom
(72) Inventor(s)
(74) Agent/Address for service: FISHER, CORMACK & BOTHA, P. O. Box 74, Blantyre, Malawi
(54) Title: CAPPED OLIGOSACCHARIDES COMPRISING SEVEN OR MORE UNITS OF 4,6-DIDEOXY-4-ACYLAMIDO-ALPHA-PYRANOSE AND CONJUGATES THEREOF AS VACCINES AGAINST INFECTIONS CAUSED BY BRUCELLA ORGANISMS
(51) Int.Cl.: G 01N 33/53, C 07H 15/18, C 07H 5/06
(57) Abstract: There is provided a molecule comprising a chain of seven or more contiguous units of 4,6-dideoxy-4-acylamido- α -pyranose, each pair of units joined by a C₁-C₂ or a C₁-C₃ link, the chain having a terminal end and a reducing end, wherein the pyranose ring in the unit of the chain most distal from the reducing end is linked to a cap structure. The cap structure is not a 4,6-dideoxy-4-acylamido- α -pyranose. There are also provided vaccine compositions comprising the molecule and methods of vaccinating an animal against infection by a Brucella organism, including methods of distinguishing between a vaccinated and an infected animal. There are further provided novel methods of detecting the presence in a sample of an anti-Brucella antibody.

.....

(11) Patent Number: 6612 date of grant: 05/01/2023
(21) Application Number: 2020/12840 (22) Filing Date: 23/05/2019
(30) Priority:1810046.1 19/06/2018 GB
(73) Owner(s): HAYGROVE LIMITED of Redbank, Ledbury, Hereford and Worcester HR8 2JL, United Kingdom
(72) Inventor(s)
(74) Agent/Address for service: FISHER CORMACK & BOTHA, P. O. Box 74, Blantyre, Malawi
(54) Title: POLYTUNNEL STRUCTURE
(51) Int.Cl.: A 01G 9/24, A 01G 9/14
(57) Abstract: A polytunnel structure (10) is described comprising a plurality of cover support members (16) supported upon respective pairs of legs (12), a cover member (18) supported by the cover support members (16), an edge of the cover member (18) being secured to a rotatable beam (20), and an anchor rope (22), strap or the like extending over the cover member (18) to anchor the cover member (18) in position, wherein the cover support members (16) are each shaped to define a step (26) between a first section (28) and a second section (30), wherein when the rotatable beam (20) is supported upon the second section (30), the anchor rope (22), strap or the like provides a reduced resistance to movement thereof.

.....

(11) Patent Number: 6613 date of grant: 18/01/2023
(21) Application Number: 2020/12794 (22) Filing Date: 26/04/2019
(30) Priority:10 2018 206 673.6 30/04/2018 DE
(73) Owner(s): THYSSENKRUPP INDUSTRIAL SOLUTIONS AG of ThyssenKrupp Allee 1 45143 Essen, Germany
(72) Inventor(s)
(74) Agent/Address for service: FISHER CORMACK & BOTHA, P. O. Box 74, Blantyre, Malawi
(54) Title: OXYFUEL CLINKER PRODUCTION WITH SPECIAL OXYGEN ADDITION
(51) Int.Cl.: C 04B 7/36, F 27B 7/38, F 27B 7/36
(57) Abstract: Methods and systems for the production of cement clinker, wherein an oxygen-containing gas, which has a proportion of 15 vol.% or less of nitrogen and a proportion of 50 vol.% or more of oxygen, is guided from a first section of the cooler directly adjoining the kiln head to the rotating kiln and optionally also guided to the calciner and wherein more than 50 vol.% (preferably more than 85 vol.%) of the gas flows supplied to the combustion processes in total consist of oxygen.

.....

(11) Patent Number: 6614 date of grant: 18/01/2023
(21) Application Number: 2020/12812 (22) Filing Date: 26/04/2019

(30) Priority:10 2018 206 674.4 30/04/2018 DE

(73) Owner(s): THYSSENKRUPP INDUSTRIAL SOLUTIONS AG of ThyssenKrupp Allee 1 45143 Essen, Germany

(72) Inventor(s)

(74) Agent/Address for service: FISHER CORMACK & BOTHA, P. O. Box 74, Blantyre, Malawi

(54) Title: OXYFUEL CLINKER PRODUCTION WITHOUT RECIRCULATION OF THE PREHEATER EXHAUST GASES

(51) Int.Cl.: C 04B 2/10, C 04B 7/43, F 27B 19/04, F 27B 7/20

(57) Abstract: The invention relates to methods and installations for producing cement clinker without recirculation of the preheater exhaust gases, wherein, in said preheater, the ratio of supplied solid to waste gas is set to greater than 1.0 kg solid to gas.

.....

(11) Patent Number: 6615 date of grant: 19/01/2023

(21) Application Number: 2021/12987 (22) Filing Date: 29/08/2019

(30) Priority:62/726,520 04/09/2018 US

(73) Owner(s): ELI LILLY AND COMPANY of Lilly Corporate Center, Indianapolis, Indian 46285, United States of America

(72) Inventor(s)

(74) Agent/Address for service: ADAMS AND ADAMS MOZAMBIQUE, Rua Estevão Ata-de, #20 R/C Bairro da Sommerschild Maputo, Mozambique

(54) Title: 2,6-DIAMINO PYRIDINE COMPOUNDS

(51) Int.Cl.: C 07D 213/00, A 61K 31/4439, A 61P 9/04, A 61P 3/10

(57) Abstract: The present invention provides a compound of Formula I or a pharmaceutically acceptable salt thereof, and the use of compounds of Formula I for treating metabolic conditions, such as type 2 diabetes mellitus, heart failure, diabetic kidney disease, and non-alcoholic steatohepatitis.

.....

(11) Patent Number: 6618 date of grant: 20/01/2023

(21) Application Number: 2020/12696 (22) Filing Date: 01/04/2019

(30) Priority:18165619.0 04/04/2020 EP

(73) Owner(s): ROCKWOOL INTERNATIONAL A/S of Hovedgade 584 2640 Hedehusene, Denmark

(72) Inventor(s)

(74) Agent/Address for service: ENSafrica Namibia, Private Bag 12007, Ausspannplatz, Windhoek, Namibia

(54) Title: SECURITY BARRIER MADE OF MINERAL WOOL FILLABLE WITH A LIQUID

(51) Int.Cl.: E 01F 15/14, E 01F 15/08

(57) Abstract: The present invention concerns a security barrier for providing protection in a public space or the like, said barrier comprising a mineral wool assembly (1) comprising at least one mineral wool element (1', 1", 1''') having an outer liquid impermeable covering (5) and wherein the at least one mineral wool element is adapted for being filled with a liquid. The invention further comprises a method of manufacturing such security barrier and a method of preparing the security barrier for providing protection in a public space.

.....

(11) Patent Number: 6620 date of grant: 23/01/2023

(21) Application Number: 2019/11499 (22) Filing Date: 27/10/2017

(30) Priority:16306415.7 28/10/2016 EP

(73) Owner(s): LES LABORATOIRES SERVIER of 35 Rue de Verdun, 92284 Suresnes, France and NOVARTIS AG of Lichtstrasse 35, 4056 Basel, Switzerland

(72) Inventor(s)

(74) Agent/Address for service: FISHER, CORMACK & BOTHA, P. O. Box 74, Blantyre, Malawi

(54) Title: LIPOSOMAL FORMULATION FOR USE IN THE TREATMENT OF CANCER

(51) Int.Cl.: A 61K 31/519, A 61K 9/127, A 61P 35/00

(57) Abstract: The invention relates to a pharmaceutical liposomal composition comprising 2-[[5-{3-chloro2-methyl-4-[2-(4-methylpiperazin-1-yl)ethoxy]phenyl}-6-(4-fluorophenyl)thieno [2,3-d]pyrimidin-4-yl]oxy}-3-(2-[[2-(2-methoxyphenyl) pyrimidin-4-yl]methoxy]phenyl) propanoic acid, referred to herein as 'Compound A', or a pharmaceutically acceptable salt thereof. More specifically the invention relates to a liposomal vehicle, an organic concentrate composition comprising Compound A, and a pharmaceutical composition for parenteral administration comprising liposomes and Compound A. Furthermore, the invention relates to the use of such compositions for the treatment of cancer. 'Compound A' as used herein includes all enantiomers, diastereoisomers, and atropisomers thereof, or mixtures thereof, and also optionally includes the pharmaceutically acceptable salts thereof

.....

(11) Patent Number: 6624 date of grant: 25/01/2023
(21) Application Number: 2018/11064 (22) Filing Date: 05/05/2017
(30) Priority:2016901686 06/05/2016 AU and 2016901741 10/05/2016 AU
(73) Owner(s): BULK ORE SHUTTLE SYSTEM PTY LTD of 235 Mill Point Road, South Perth, Western Australia 6151, Australia
(72) Inventor(s)
(74) Agent/Address for service: GALLOWAY & COMPANY, P O Box A761, Avondale, Harare, Zimbabwe
(54) Title: RAIL TRANSPORT SYSTEM
(51) Int.Cl.: B 61C 13/00, B 61D 17/18, B 61D 3/00, B 61D 11/00, B 61D 7/00, B 61D 9/14, B 61D 9/00, B 61F 13/00, B 65G 67/02, B 65G 67/42
(57) Abstract: A rail transport system 10 has at least two load carrying bodies 12 which are arranged end to end. Mutually adjacent bodies 12 are coupled together by respective coupling systems 14. The rail transport system 10 further includes a plurality of axles 16 each provided at opposite ends with respective rail wheels 18 which support the bodies 12. A flexible liner 20 is supported by the bodies 12. The liner 20 is configured to span respective coupling systems 14. In this way the bodies 12 and the flexible liner 20 form a continuous load carrying structure 22. The continuous load carrying structure 22 is arranged so as to be able to pivot about an axis perpendicular to the axles 16 to facilitate unloading of cargo from the bodies 12.

.....

(11) Patent Number: 6628 date of grant: 26/01/2023
(21) Application Number: 2019/12084 (22) Filing Date: 14/03/2018
(30) Priority:62/521,147 16/06/2017 US
(73) Owner(s): TELEFONAKTIEBOLAGET LM ERICSSON (PUBL) of 164 83 Stockholm, Sweden
(72) Inventor(s)
(74) Agent/Address for service: FISHER CORMACK & BOTHA, P.O. Box 74, Blantyre, MALAWI
(54) Title: UPLINK POWER CONTROL BASED ON MULTIPLE REFERENCE SIGNALS
(51) Int.Cl.: H 04B 7/06, H 04L 27/26, H 04W 52/32, H 04W 52/24, H 04W 72/04, H 04W 52/14
(57) Abstract: According to certain embodiments, a method implemented in a wireless device comprises determining configuration data representing a set of configurations. The method comprises receiving at least one reference signal from a transmission point. The receiving of the at least one reference signal is performed in accordance with a configuration selected from the set, wherein the configuration is related to uplink power control and is specific to an uplink channel or signal or a group thereof. The method comprises measuring a propagation-related quantity on the basis of the at least one reference signal and deriving an uplink power setting on the basis of the measured propagation-related quantity.

.....

(11) Patent Number: 6629 date of grant: 27/01/2023
(21) Application Number: 2020/12722 (22) Filing Date: 05/04/2019
(30) Priority:62/653566 06/04/2018 US
(73) Owner(s): TELEFONAKTIEBOLAGET LM ERICSSON (PUBL) of SE-164 83 Stockholm, Sweden
(72) Inventor(s)
(74) Agent/Address for service: FISHER CORMACK & BOTHA, P. O. Box 74, Blantyre, Malawi
(54) Title: BANDWIDTH PART SWITCHING
(51) Int.Cl.: H 04L 5/00, H 04W 72/04, H 04W 36/00
(57) Abstract: A network node and wireless device and methods for switching between an active bandwidth part and the target bandwidth part. According to one aspect a method in a network node comprises selecting one or more resource blocks comprised in the target bandwidth part for a transmission or reception between the wireless device and the network node. The method further comprises indicating the selected resource blocks to be used in the target bandwidth part in a resource allocation field of a downlink control channel information in the active bandwidth part, the allocation field comprising information bits and wherein the resource allocation field in the active bandwidth part and the information bits therein are configured based on a target bandwidth part resource allocation type wherein the target bandwidth part resource allocation type indicates whether the information bits comprise a bitmap corresponding to one or more resource block groups or an integer value corresponding to a starting resource block and a length of the allocation in resource blocks.

.....

(11) Patent Number: 6630 date of grant: 27/01/2023
(21) Application Number: 2013/7014 (22) Filing Date: 24/01/2012
(30) Priority:61/435,398 24/01/2011 US
(73) Owner(s): NOVOMATIC AG of Wiener Strasse 158, 2352 Gumpoldskirchen, Austria
(72) Inventor(s)
(74) Agent/Address for service: FISHER CORMACK & BOTHA, P O Box 74 Blantyre, MALAWI

(54) Title: Gaming machine, system and method for playing a feature game

(51) Int.Cl.: G 07F 17/32

(57) Abstract: A gaming system and method involving a fixed bonus code and dynamic game code wherein one or more players playing multiple designated electronic gaming machines attempt to match a dynamic game code to the bonus code to win a fixed jackpot or progressive jackpot. The game code symbols adjust randomly (i.e., change) responsive to each play of a corresponding electronic gaming machine. Once a game code symbol matches a corresponding bonus code symbol, the game code symbol locks up such that the matching game code symbol cannot adjust again until the jackpot is won based on each game code symbol matching a corresponding bonus code symbol. Different electronic gaming machines may be re-assigned to drive different game code symbols as needed.

.....

(11) Patent Number: 6631 date of grant: 30/01/2023

(21) Application Number: 2018/11227 (22) Filing Date: 29/07/2016

(30) Priority:

(73) Owner(s): Permanent Privacy Ltd. of Sea Meadow House Blackburne Highway Road Town, Tortola, British Virgin Islands

(72) Inventor(s)

(74) Agent/Address for service: FISHER CORMACK & BOTHA, P. O. Box 74, Blantyre, Malawi

(54) Title: APPLICATIONS IN CONNECTION WITH SECURE ENCRYPTION

(51) Int.Cl.: H 04L 9/06

(57) Abstract: An encryption box device has a memory and a processor coupled to the memory. A first clipboard runs on the processor and downloads a plaintext stream. An encryption engine runs on the processor and receives the plaintext stream and encrypts the plaintext stream to produce an encrypted stream. A digitizer runs on the processor and digitizes the encrypted stream to produce a digitized encrypted stream. A second clipboard runs on the processor and uploads the digitized encrypted stream. The encryption engine may also decrypt the encrypted stream to produce the plaintext stream and upload the plaintext stream to the first clipboard.

.....

(11) Patent Number: 6632 date of grant: 30/01/2023

(21) Application Number: 2019/11438 (22) Filing Date: 29/08/2017

(30) Priority:201621029473 30/08/2016 IN

(73) Owner(s): MOJJ ENGINEERING SYSTEMS LTD of 81-15/B, M. I. D. C.Bhosari, Pune 411026, India

(72) Inventor(s)

(74) Agent/Address for service: GALLOWAY & COMPANY, P O Box A761 Avondale, Harare, Zimbabwe

(54) Title: BIO-METHANATED SPENT WASH EVAPORATION PROCESS USING MULTI STAGE DEGASSING SYSTEM

(51) Int.Cl.: B 01D 19/00, C 04B 18/00, C 12F 3/00

(57) Abstract: Bio-Methanated Spent wash Evaporation Process Using Multi Stage Degassing System The present invention discloses a two stage degassing system for defoaming of bio-methanated spent wash wherein the spent wash is degassed at lower temperature and higher vacuum in the first stage and at higher temperature and lower vacuum in the second stage in multi tray column and/or a third stage thermo-mechanical degassing before it is subjected to multiple effect evaporation for concentration. The invention also discloses use of an optional pressure spray ring instead of fresh steam to deactivate the mycelium more effectively and also reduce the energy consumption of the overall evaporation unit. The invention further discloses a reactor design wherein two stage degassing of bio-methanated spent wash can be performed.

.....

(11) Patent Number: 6634 date of grant: 30/01/2023

(21) Application Number: 2020/12468 (22) Filing Date: 11/12/2018

(30) Priority:2017-251785 27/12/2017 JP

(73) Owner(s): KANEKA CORPORATION of 3-18, Nakanoshima 2-chome, Kita-ku, Osaka-shi, Osaka 530-8288, Japan

(72) Inventor(s)

(74) Agent/Address for service: CronjÃ© & Co., 1 Charles Cathral Street, Olympia, Windhoek, Namibia

(54) Title: ARTIFICIAL HAIR, HEAD DECORATION PRODUCT INCLUDING SAME, AND ARTIFICIAL HAIR PRODUCTION METHOD

(51) Int.Cl.: A 41G 3/00, A 61Q 5/00

(57) Abstract: The present invention pertains to artificial hair in which a fiber treating agent composition is adhered to the surface of chemical fibers, wherein the fiber treating agent composition contains an oxazoline group-containing acrylic resin and an organic-modified silicone oil, and the oxazoline group-containing acrylic resin has a main chain including a (meth)acrylic ester and styrene. Further, the present invention pertains to a

head decoration product including said artificial hair. Accordingly, the present invention provides: artificial hair having a smooth texture and excellent combing durability; and a head decoration product including said artificial hair.

.....

(11) Patent Number: 6637 date of grant: 01/02/2023
(21) Application Number: 2019/12100 (22) Filing Date: 14/06/2018
(30) Priority:62/520,047 15/06/2017 US
(73) Owner(s): Reventech Inc. of Jayla Place Wickams Cay I Road Town Tortola, British Virgin Islands
(72) Inventor(s)
(74) Agent/Address for service: FISHER CORMACK & BOTHA, P.O. Box 74, Blantyre, MALAWI
(54) Title: PROCESS TO PRODUCE HYDROGEN FROM UNDERGROUND GEOTHERMAL RESERVOIRS
(51) Int.Cl.: E 21B 36/00, E 21B 43/38, E 21B 43/08, E 21B 43/00
(57) Abstract: A geothermal reservoir induces gasification and water gas shift reactions to generate hydrogen. The hydrogen or protons are produced to surface by using hydrogen-only or proton-only membranes in production wells. Energy from the reservoir is produced to surface as protons or hydrogen.

.....

(11) Patent Number: 6639 date of grant: 02/02/2023
(21) Application Number: AP/P/2018/011047 / (22) Filing Date: 11/04/2017
(30) Priority: 16165029.6 13/04/2016 EP
(73) Owner(s): IMD Natural Solutions GmbH of Otto-Hahn-Stra e 15, 44227 Dortmund, Germany
(72) Inventor(s)
(74) Agent/Address for service: ,
(54) Title: FORMULATION SYSTEMS FOR ANTIMICROBIAL GLYCOLIPIDS
(51) Int.Cl.: A 01N 43/14, A 01N 63/02, A 01P 1/00, C 07H 15/04, C 12P 19/44
(57) Abstract: The invention relates to a composition comprising one or more antimicrobial glycolipids and one or more formulation stabilizers. The invention also relates to methods of preparing the compositions and their application in water containing food, beverage, cosmetic, home care and medical products.

.....

(11) Patent Number: 6640 date of grant: 02/02/2023
(21) Application Number: 2020/12763 (22) Filing Date: 04/05/2018
(30) Priority:PCT/CN2018/083124 13/04/2018 CN
(73) Owner(s): NOKIA TECHNOLOGIES OY of Karakaari 7, 02610 Espoo, Finland
(72) Inventor(s)
(74) Agent/Address for service: GALLOWAY & COMPANY, P. O. Box A761 Avondale, Harare, Zimbabwe
(54) Title: ENHANCEMENT OF MEDIUM ACCESS CONTROL SUBHEADERS
(51) Int.Cl.: H 04W 80/00
(57) Abstract: In accordance with an example embodiment of the apparatus there is at least a method and apparatus to perform determining a grant for data to be communicated, comprising identifying logical channels to be multiplexed into a medium access control protocol data unit for the data to be communicated, wherein at least one of a logical channel identifier for at least one logical channel of the multiplexed logical channels and length of at least one logical channel service data unit is configured to be omitted from the medium access control protocol data unit. Further in accordance with an example embodiment of the apparatus there is at least a method and apparatus to perform receiving a grant for the data to be communicated, comprising logical channels multiplexed into a medium access control protocol data unit for the data to be communicated, wherein at least one of a logical channel identifier for at least one logical channel of the multiplexed logical channels and length of at least one logical channel service data unit is configured to be omitted from the medium access control protocol data unit.

.....

(11) Patent Number: 6642 date of grant: 03/02/2023
(21) Application Number: 2019/11737 (22) Filing Date: 20/12/2017
(30) Priority:1621732.5 20/12/2016 GB
(73) Owner(s): AGRICULTURAL RESEARCH COUNCIL of 1134 Park Street, Hatfield, 0083 Pretoria, South Africa
(72) Inventor(s)
(74) Agent/Address for service: FISHER CORMACK & BOTHA, P O Box 74, Blantyre, MALAWI
(54) Title: A MULTI-EPITOME DNA VACCINE FOR HEARTWATER
(51) Int.Cl.: C 07K 14/29, A 61K 39/02
(57) Abstract: The present invention relates to nucleic acids comprising sequences encoding Ehrlichia ruminantium epitopes which induce a CD4 immune response, and sequences encoding Ehrlichia ruminantium

epitopes which induce a CD8 immune response. The invention also relates to multi-epitope DNA vaccines comprising the nucleic acids and the polypeptides encoded by the nucleic acids. The invention further relates to uses and methods of eliciting an immune response against heartwater disease in a subject using the nucleic acids, multi-epitope DNA vaccines and polypeptides.

.....

(11) Patent Number: 6643 date of grant: 03/02/2023
(21) Application Number: 2019/11813 (22) Filing Date: 31/01/2018
(30) Priority:62/452,804 31/01/2017 US; 62/452,816 31/01/2017 US and 62/510,723 24/05/2017 US
(73) Owner(s): MS Biotech, Inc. of 2489 W. Main Street, Littleton, Colorado 80120, United States of America, +1, U.S.A. and KANSAS STATE UNIVERSITY RESEARCH FOUNDATION of 2005 Research Park Circle, Suite 105, Manhattan, Kansas 66502, United States of America
(72) Inventor(s)
(74) Agent/Address for service: FISHER CORMACK & BOTHA, P. O. Box 74 Blantyre MALAWI
(54) Title: MICROBIAL CELLS, METHODS OF PRODUCING THE SAME, AND USES THEREOF
(51) Int.Cl.: C 12N 1/00, C 12N 1/14, C 12N 1/04, C 12N 1/21, A 23K 1/18, A 23K 1/00, A 61P 31/04
(57) Abstract: The present invention relates to microbial cells, including but not limited to aerobic bacteria cells and anaerobic bacteria cells, as well as yeast cells, and methods for producing the cells, feed additives and compositions comprising the cells, and uses involving administration of the cells to animals.

.....

(11) Patent Number: 6644 date of grant: 03/02/2023
(21) Application Number: 2020/12800 (22) Filing Date: 29/05/2019
(30) Priority:2018-103058 30/05/2018 JP
(73) Owner(s): AQUASOLUTION CORPORATION of 443, Kazawa, Tomi-shi, Nagano 389-0514, Japan
(72) Inventor(s)
(74) Agent/Address for service: HUSSEIN RANCHHOD & CO, Ground Floor, Block 1 Arundel Office Park, Norfolk Road, Mount Pleasant, Harare, Zimbabwe
(54) Title: SOIL AMELIORATION METHOD
(51) Int.Cl.: A 01G 22/15, A 01G 7/00, A 01G 22/60
(57) Abstract: The present invention addresses the problem of providing a soil amelioration method that makes it possible to conveniently ameliorate soil. This soil amelioration method involves applying nano-bubble water to soil.

.....

(11) Patent Number: 6645 date of grant: 03/02/2023
(21) Application Number: 2020/12801 (22) Filing Date: 29/05/2019
(30) Priority:2018-103097 30/05/2018 JP
(73) Owner(s): AQUASOLUTION CORPORATION of 443, Kazawa, Tomi-shi, Nagano 389-0514, Japan
(72) Inventor(s)
(74) Agent/Address for service: HUSSEIN RANCHHOD & CO, Ground Floor, Block 1 Arundel Office Park, Norfolk Road, Mount Pleasant, Harare, Zimbabwe
(54) Title: FERTILIZER ABSORPTION IMPROVEMENT METHOD
(51) Int.Cl.: A 01G 22/25, A 01G 22/60, A 01G 7/00, C 05G 3/00
(57) Abstract: The present invention addresses the problem of providing a fertilizer absorption improvement method that makes it possible to conveniently improve fertilizer absorption. This fertilizer absorption improvement method involves applying nano-bubble water to a plant.

.....

(11) Patent Number: 6647 date of grant: 17/02/2023
(21) Application Number: 2019/11746 (22) Filing Date: 24/04/2019
(30) Priority:PCT/CN2018/085165 28/04/2018 CN
(73) Owner(s): TELEFONAKTIEBOLAGET LM ERICSSON (PUBL) of SE-164 83 Stockholm, Sweden
(72) Inventor(s)
(74) Agent/Address for service: FISHER CORMACK & BOTHA, P. O. Box 74, Blantyre, Malawi
(54) Title: QoS FLOW CONTROL PARAMETERS SIGNALING
(51) Int.Cl.:
(57) Abstract: The present disclosure provides methods for signaling QoS Flow control parameters, and corresponding NF entities. The method comprises generating one or more data flow rules associated with a QoS Flow and a QoS Flow profile. The data flow rules include parameters specific to a data flow that belongs to the QoS Flow, while the QoS Flow profile includes parameters that are common to all data flows that belong to the

same QoS Flow. The present disclosure further discloses a corresponding method of receiving the QoS Flow control parameters. The present disclosure further provides corresponding computer readable medium.

.....

(11) Patent Number: 6648 date of grant: 07/02/2023
(21) Application Number: 2020/12476 (22) Filing Date: 06/11/2014
(30) Priority:61/902,544 11/11/2013 US
(73) Owner(s): GILEAD SCIENCES, INC. of 333 Lakeside Drive, Foster City, CA 94404, United States of America
(72) Inventor(s)
(74) Agent/Address for service: B. W. KAHARI LEGAL PRACTITIONERS, 24 Lanark Road, Avondale, Harare, Zimbabwe
(54) Title: PYRROLO [1,2,F] [1,2,4] TRIAZINES USEFUL FOR TREATING RESPIRATORY SYNCYTIAL VIRUS INFECTIONS
(51) Int.Cl.: C 07D 487/04, A 61K 31/16, A 61K 31/706
(57) Abstract: Provided herein are formulations, methods and substituted tetrahydrofuranyl- pyrrolo[1,2-f][1,2,4]triazine-4-amine compounds of Formula (I) for treating Pneumovirinae virus infections, including respiratory syncytial virus infections, as well as methods and intermediates for synthesis of tetrahydrofuranyl-pyrrolo[1,2-fj[i,2,4]triazine-4-amine compounds.

.....

(11) Patent Number: 6650 date of grant: 23/02/2023
(21) Application Number: 2019/11682 (22) Filing Date: 08/12/2016
(30) Priority:201611090494.2 30/11/2016 CN
(73) Owner(s): Shanghai Transsion Information Technology Limited of Mengqi, Wang, Intellectual Property Department, No. 1 Building, 433 Lane, Guoshoujing Road, Pudong District Shanghai 201203, People's Republic of China
(72) Inventor(s)
(74) Agent/Address for service: ADAMS AND ADAMS MOZAMBIQUE, Rua Estevão Ata-de, #20, R/C Bairro da Sommerschild, Maputo, Mozambique
(54) Title: USB CONNECTOR SOCKET AND USB CONNECTOR
(51) Int.Cl.: H 01R 13/02
(57) Abstract: A USB connector socket (200), comprising a socket shell, a tongue plate located in the socket shell, and a plurality of terminals fixed on the tongue plate, wherein the plurality of terminals comprise a power supply terminal (201), a grounding terminal (205) and a plurality of data signal terminals (202-204) between the power supply terminal (201) and the grounding terminal (205). The power supply terminal (201) and the grounding terminal (205) both comprise: a front-end part (201a); and an extension part (201b) extending backwardly and outwardly from the tail end of the front-end part (201a). By means of this structure, the contact reliability and charging efficiency of a USB connector is improved.

.....

(11) Patent Number: 6651 date of grant: 23/02/2023
(21) Application Number: 2020/12203 (22) Filing Date: 02/08/2018
(30) Priority: 62/541,627 04/08/2017 US
(73) Owner(s): BAYER PHARMA AKTIENGESELLSCHAFT of MÅllerstr. 178, 13358 Berlin 13353, Germany; BAYER AKTIENGESELLSCHAFT of Kaiser-Wilhelm-Allee 1, 51373 Leverkusen, Germany; THE BROAD INSTITUTE, INC. of 415 Main Street, Cambridge, Massachusetts 02142, United States of America and DANA-FARBER CANCER INSTITUTE, INC. of 450 Brookline Avenue, Boston, Massachusetts 02215, United States of America
(72) Inventor(s)
(74) Agent/Address for service: ADAMS AND ADAMS MOZAMBIQUE, Rua Estevão Ata-de, #20, R/C Bairro da Sommerschild, Maputo, Mozambique
(54) Title: DIHYDROOXADIAZINONES
(51) Int.Cl.: C 07D 273/04, C 07D 417/10, C 07D 491/107, C 07D 413/10, A 61K 31/5395, A 61P 35/00
(57) Abstract: The present invention provides dihydroxydiazinone compounds of general formula (I) : in which R¹ , R² , R³ , and R⁴ , are as defined herein, methods of preparing said compounds, intermediate compounds useful for preparing said compounds, pharmaceutical compositions and combinations comprising said compounds and the use of said compounds for manufacturing pharmaceutical compositions for the treatment or prophylaxis of diseases, in particular of hyperproliferative diseases, as a sole agent or in combination with other active ingredients.

.....

(11) Patent Number: 6652 date of grant: 23/02/2023
(21) Application Number: 2020/12888 (22) Filing Date: 07/06/2019

(30) Priority:62/681,847 07/06/2018 US and 62/777,491 10/12/2018 US
(73) Owner(s): SEAGEN INC. of 21823 30th Drive SE Bothell, Washington 98021, United States of America
(72) Inventor(s)
(74) Agent/Address for service: FISHER CORMACK & BOTHA, P. O. Box 74, Blantyre, Malawi
(54) Title: CAMPTOTHECIN CONJUGATES
(51) Int.Cl.: C 07D 491/22, A 61K 47/68, A 61P 35/00
(57) Abstract: Antibody conjugates with camptothecin compounds are described, with methods of use and preparations.

.....

(11) Patent Number: 6654 date of grant: 27/02/2023
(21) Application Number: 2020/12223 (22) Filing Date: 27/07/2017
(30) Priority:
(73) Owner(s): NTT DOCOMO, INC. of 11-1, Nagatacho 2-chome, Chiyoda-ku, Tokyo 100-6150, Japan
(72) Inventor(s)
(74) Agent/Address for service: FISHER CORMACK & BOTHA, P. O. Box 74, Blantyre, MALAWI
(54) Title: USER TERMINAL AND RADIO COMMUNICATION METHOD
(51) Int.Cl.: H 04W 72/04
(57) Abstract: This user terminal is characterized by comprising: a control unit which determines the relation between a prescribed control resource set and a prescribed bandwidth part (BWP), and a transmitting/receiving unit which, in the case of detecting downlink control information in the aforementioned prescribed control resource set, performs transmission and/or receiving in the prescribed BWP on the basis of the aforementioned relation. It is possible to prevent reduction in communication throughput even when performing control based on the BWP.

.....

(11) Patent Number: 6655 date of grant: 28/02/2023
(21) Application Number: 2019/12118 (22) Filing Date: 17/12/2019
(30) Priority:201910482606.6 04/06/2019 CN
(73) Owner(s): SHENZHEN TRANSSION HOLDINGS CO., LTD. of Room 1702-1703, Desay Building, No. 9789 Shennan Road, Hi-tech Park, Nanshan District, Shenzhen, China
(72) Inventor(s)
(74) Agent/Address for service: INVENTA MOZAMBIQUE, LDA., Av. 25 de Setembro, 1821 Maputo, Mozambique
(54) Title: MOBILE TERMINAL AND METHOD FOR DISPLAYING NOTIFICATION ON MOBILE TERMINAL
(51) Int.Cl.2016.01: H 02J 3/38
(57) Abstract: Disclosed are a control method for battery charging, an intelligent terminal and a charging system, which relates to the technical field of intelligent terminal charging. The control method for battery charging is applied to a charging process of an intelligent terminal by a power adapter. The method includes: detecting, whether the power adapter is operable under a constant current output, and a maximum current value of the constant current; controlling the power adapter to output in the constant current with the maximum current value in a preset charging phase, when the constant current output is detected operable. According to the present technical solution, the intelligent terminal can cooperate with a power supply operable under the constant current output, to charge the battery with a high efficiency, reduce the heat and power loss in charging.

.....

(11) Patent Number: 6656 date of grant: 28/02/2023
(21) Application Number: 2020/12153 (22) Filing Date: 13/01/2020
(30) Priority:201910876620.4 17/09/2019 CN
(73) Owner(s): SHENZHEN TRANSSION HOLDINGS CO., LTD. of Room 1702-1703, Desay Building, No. 9789 Shennan Road, Hi-tech Park, Nanshan District, Shenzhen, China
(72) Inventor(s)
(74) Agent/Address for service: HUSSEIN RANCHHOD & CO, Ground Floor, Block 1 Arundel Office Park, Norfolk Road, Mount Pleasant, Harare, Zimbabwe
(54) Title: METHOD AND DEVICE FOR GENERATING PAINTING IMAGE, TERMINAL AND STORAGE MEDIUM
(51) Int.Cl.2016.01: G 06T 15/00, G 06T 7/00, G 06T 19/00
(57) Abstract: The present application discloses a method for generating a painting image, which includes the following operations: processing an acquired target picture as a painting template; and acquiring an editing operation based on the painting template and obtaining the painting image. The present application further discloses a device for generating a painting image, a terminal and a storage medium. According to the present application, the painter may select a painting template from different pictures according to individual needs or wishes to perform the painting operation. It avoids the problem that individual needs of the painter may not

be satisfied due to limitation of the terminal storage space, and limitation of picture templates built in the painting application. In addition, it avoids occupying a large amount of terminal memory due to the large number of image templates built in the painting application.

.....

(11) Patent Number: 6658 date of grant: 28/02/2023
(21) Application Number: 2020/12443 (22) Filing Date: 22/08/2018
(30) Priority:10 2017 120 212.9 01/09/2017 DE
(73) Owner(s): BIOGENTS AG of Weissenburgerstrasse 22, Regensburg, 93055, Germany
(72) Inventor(s)
(74) Agent/Address for service: COGHLAN, WELSH & GUEST, Cecil House, 2 Central Avenue, P. O. Box 53, Harare, Zimbabwe
(54) Title: INSECT TRAP AND METHOD FOR ATTRACTING AND/OR CAPTURING FLYING INSECTS
(51) Int.Cl.: A 01M 1/06
(57) Abstract: The invention relates to an insect trap (10) and a method for attracting and/or capturing flying insects and/or insect pests (12). The trap (10) has a suction opening (14) which continues into a suction channel (16), in which there is an air flow (18) applying the suction opening (14) with a negative pressure or with a suction flow, and leading to an internal space (20) of the insect trap (10). The trap (10) also has a surface which surrounds the suction channel (16) near the suction opening (14), encases the suction channel (16) in a further region at a varying radial distance, widens in a direction parallel to the direction of the air flow (18) passing through the suction channel (16), and is at least partially permeable to out-flowing air (24), and which forms at least one part of an outer wall (22) of the insect trap (10). In addition, an end or base side (28) is provided, which is connected to the outer wall (22), is substantially impermeable to in- or out-flowing air, and is positioned opposite the suction opening (14), and which is at least slightly spaced apart from an open end side (30) of the suction channel (16) extending into the internal space (20) of the trap (10).

.....

(11) Patent Number: 6659 date of grant: 28/02/2023
(21) Application Number: 2020/12610 (22) Filing Date: 19/02/2019
(30) Priority:62/632,348 19/02/2018 US
(73) Owner(s): DERRICK CORPORATION of 590 Duke Road Buffalo, New York 14225, United States of America
(72) Inventor(s)
(74) Agent/Address for service: ENSafrica Namibia, Private Bag 12007, Ausspannplatz, Windhoek, Namibia
(54) Title: ECCENTRIC VIBRATOR SYSTEMS AND METHODS
(51) Int.Cl.: B 06B 1/16
(57) Abstract: An apparatus that generates vibrational motion is disclosed. The apparatus includes a first mass, a second mass, a drive system, and a control system. The first mass is eccentrically mounted on, and configured to rotate about, a first shaft. The second mass is eccentrically mounted on, and configured to rotate about, a second shaft, with first and second shafts sharing a common axis. The drive system imparts rotational motion to first and second shafts, and the control system controls rotational frequencies, directions, and initial angles of the first and second masses. Linear, elliptical, or circular vibratory motion of the apparatus may be induced by controlling such rotational properties of the first and second masses. The apparatus may include a measurement device that measures angular position and/or velocity of the first and second masses. The control system may control the vibrational motion based on measurements taken by the measurement device.

.....

(11) Patent Number: 6661 date of grant: 28/02/2023
(21) Application Number: 2020/12753 (22) Filing Date: 22/04/2019
(30) Priority:119/2018 23/04/2018 BD
(73) Owner(s): AHMED Mio of Miyanomori 4-3-3-3, Chuo-Ku, Sapporo, Hokkaido, 0640954, Japan
(72) Inventor(s)
(74) Agent/Address for service: ROLAND INTELLECTUAL PROPERTY CONSULTANTS, 3 Maritz Street, Windhoek, P. O. Box 91198, Windhoek, Namibia
(54) Title: SYSTEM AND METHOD OF OPERATING OPEN ENDED INTERACTIVE VOICE RESPONSE IN ANY SPOKEN LANGUAGES
(51) Int.Cl.: H 04M 3/493, G 06F 17/28
(57) Abstract: System and method of operating open ended interactive voice response in any spoken languages such as Austroasiatic, Austronesian, Dravidian, Indo-Aryan, Afroasiatic, SinoTibetan and Tai-Kadai, discloses the invention of open Ended Interactive Voice Response System, wherein customer just have to speak their desired intention in a spoken languages and the system will take care of the rest, thus making it efficient, user friendly, secure and unified. Whereas, IVR also serves businesses by eliminating their need to create and

maintain any IVR systems, secure integration with other businesses and itself, worry about scalability of their systems.

.....

(11) Patent Number: 6662 date of grant: 28/02/2023
 (21) Application Number: 2020/12770 (22) Filing Date: 13/05/2019
 (30) Priority:62/671,306 14/05/2018 US and 62/749,918 24/10/2018 US
 (73) Owner(s): GILEAD SCIENCES, INC. of 333 Lakeside Drive, Foster City, CA 94404, United States of America
 (72) Inventor(s)
 (74) Agent/Address for service: B. W. KAHARI LEGAL PRACTITIONERS, 24 Lanark Road, Avondale, Harare, Zimbabwe
 (54) Title: MCL-1 INHIBITORS
 (51) Int.Cl.: C 07D 513/08, A 61K 31/553, A 61P 35/00
 (57) Abstract: The present disclosure generally relates to compounds and pharmaceutical compositions that may be used in methods of treating cancer.

.....

(11) Patent Number: 6663 date of grant: 28/02/2023
 (21) Application Number: 2021/13325 (22) Filing Date: 18/12/2019
 (30) Priority:18213505.3 18/12/2018 EP
 (73) Owner(s): STAMICARBON B. V. of Mercator 3, 6135 KW Sittard, The Netherlands
 (72) Inventor(s)
 (74) Agent/Address for service: HONEY & BLANCKENBERG, P. O. Box 85, Harare, Zimbabwe
 (54) Title: UREA GRANULATION DEVICE
 (51) Int.Cl.: B 01J 2/16, C 05C 9/00
 (57) Abstract: A fluidized bed granulator for granulation with urea or urea-containing liquids is described, wherein the granulation liquid is supplied via a supply manifold comprising a header and risers. The risers are at least in part provided inside channels for secondary gas.

.....

(11) Patent Number: 6665 date of grant: 01/03/2023
 (21) Application Number: 2014/7951 (22) Filing Date: 27/02/2013
 (30) Priority:2012900778 28/02/2012 AU; 2012903078 20/07/2012 AU and 2012903288 01/08/2012 AU
 (73) Owner(s): GLOBALTECH CORPORATION PTY LTD of 1/48 Vinnicombe Drive, Canning Vale, Western Australia 6155, Australia
 (72) Inventor(s)
 (74) Agent/Address for service: GALLOWAY & COMPANY, Baronage House, 24 Lanark Road Belgravia, Avondale, Harare Zimbabwe
 (54) Title: Improvements to downhole surveying and core sample orientation systems, devices and methods
 (51) Int.Cl.: E 21B 47/02, E 21B 25/16
 (57) Abstract: A method and system of validating orientation of a core obtained by drilling the core from a subsurface body of material, the method including: a) determining that vibration from drilling is below a nominated level, b) recording data relating to orientation of the core to be retrieved, the data recorded using a downhole core orientation data recording device, c) separating the core from the subsurface body, and d) obtaining from the core orientation data recording device an indication of the orientation of the core based on the recorded data obtained when the vibration from drilling was below the nominated level and before the core was separated from the subsurface body. A method of determining orientation of a core sample obtained by drilling from aboveground into a subsurface body includes recording data relating to a core sample being obtained by the drilling when vibration from drilling is below a threshold; providing an input to a user operated communication device; the communication device identifying a time of the user input to the communication device; retrieving the data gathering device and core sample; communicating between the communication device and the retrieved data gathering device; determining from indications provided by the retrieved data gathering device an orientation of the core sample.

.....

3.0 Patents Renewed under Section 61

3.1 National Patents

(11)/(21) 479(KE/P/2009/963)
 (71) SELEX COMMUNICATIONS S.P.A.

(24) Registration/application extended up to:
 12/03/2024

..... (11)/(21) 634(KE/P/2010/1184) (71) Astra Zeneca ABBayer Schering Pharma Aktiengesellschaft (24) Registration/application extended up to: 20/05/2023	(11)/(21) 886(KE/P/2020/3718) (71) HOCHSCHULE ANHALT (24) Registration/application extended up to: 12/03/2024
(11)/(21) 645(KE/P/2012/1656) (71) Anand, Ashish (24) Registration/application extended up to: 01/03/2023	(11)/(21) (KE/P/2020/3752) (71) SAWANT, Arun VitthalVADAKEKUTTU, Thankapan (24) Registration/application extended up to: 10/05/2024
(11)/(21) 704(KE/P/2013/1767) (71) TELEFONAKTIEBOLAGET L M ERICSSON (PUBL) (24) Registration/application extended up to: 18/03/2024	(11)/(21) (KE/P/2020/3753) (71) SAWANT, Arun Vitthal VADAKEKUTTU, Thankapan (24) Registration/application extended up to: 04/05/2024
(11)/(21) 801(KE/P/2013/1927) (71) ISHIHARA SANGYO KAISHA, LTD (24) Registration/application extended up to: 06/04/2024	(11)/(21) (KE/P/2020/3766) (71) CORTEVA AGRISCIENCE LLC (24) Registration/application extended up to: 19/05/2024
(11)/(21) (KE/P/2014/2130) (71) Shindengen Electric Manufacturing Co., Ltd (24) Registration/application extended up to: 10/05/2024	(11)/(21) (KE/P/2021/3854) (71) NOVOZYMES A/S (24) Registration/application extended up to: 20/03/2024
(11)/(21) (KE/P/2014/2142) (71) MILLENIUM PHARMACEUTICALS, INC. (24) Registration/application extended up to: 19/03/2023	(11)/(21) (KE/P/2021/3880) (71) LOHIA CORP LIMITED (24) Registration/application extended up to: 24/01/2024
(11)/(21) 888(KE/P/2017/2723) (71) TELEFONAKTIEBOLAGET LM ERICSSON (PUBL) (24) Registration/application extended up to: 25/03/2024	(11)/(21) 956(KE/P/2021/3916) (71) GALACTIC TELECOM GROUP (24) Registration/application extended up to: 14/04/2023
(11)/(21) 873(KE/P/2018/3011) (71) LOXO ONCOLOGY, INC. (24) Registration/application extended up to: 04/04/2024	(11)/(21) (KE/P/2022/4328) (71) BAYER AKTIENGESELLSCHAFT (24) Registration/application extended up to: 16/03/2024
(11)/(21) 928(KE/P/2018/3012) (71) LOXO ONCOLOGY, INC. (24) Registration/application extended up to: 04/04/2024	(11)/(21) (KE/P/2022/4343) (71) VALLOUREC TUBE-ALLOY, LLC (24) Registration/application extended up to: 31/03/2024
(11)/(21) (KE/P/2020/3637) (71) SAMSUNG ELECTRONICS CO., LTD. (24) Registration/application extended up to: 30/03/2024	(11)/(21) (KE/P/2022/4344) (71) BAYER AKTIENGESELLSCHAFT (24) Registration/application extended up to: 31/03/2024

(11)/(21) (KE/P/2013/1836)
 (71) MWAURA JOHN KAMONJO
 (24) Registration/application extended up to:
 05/06/2024

(11)/(21) 783(KE/P/2014/2030)
 (71) WANJA HANNAH DAHLHEIM
 (24) Registration/application extended up to:
 04/04/2024

(11)/(21) 931(KE/P/2017/2665)
 (71) PAN AFRICAN UNIVERSITY INSTITUTE OF
 SCIENCES TECHNOLOGY AND INNOVATION
 (PAUSTI)JOMO KENYATTA UNIVERSITY OF
 AGRICULTURE AND TECHNOLOGY(JKUAT)
 (24) Registration/application extended up to:
 22/05/2024

(11)/(21) 808(KE/P/2017/2667)
 (71) JOMO KENYATTA UNIVERSITY OF AGRICULTURE
 (JKUAT)
 (24) Registration/application extended up to:
 22/05/2024

.....

(11)/(21) 854(KE/P/2017/2683)
 (71) JOMO KENYATTA UNIVERSITY OF AGRICULTURE
 AND TECHNOLOGY (JKUAT)
 (24) Registration/application extended up to:
 13/06/2024

(11)/(21) (KE/P/2020/3612)
 (71) SHINING HOPE FOR COMMUNITIES (SHOFKO)
 (24) Registration/application extended up to:
 28/02/2024

(11)/(21) (KE/P/2020/3618)
 (71) GITHINJI JANE WANJIKU KURIA
 (24) Registration/application extended up to:
 10/03/2024

(11)/(21) 893(KE/P/2020/3623)
 (71) TOUGHBUILT INDUSTRIES, INC.
 (24) Registration/application extended up to:
 18/03/2024

4.0 Change of Address

4.1 National Patent

Application No. KE/P/2023/004419 /Registration No.:
 Old Owner Name & Address: INCLUSIVE ENERGY LTD, 465c Hornsey Road London N19 4DR, United Kingdom
 New Owner Name & Address: INCLUSIVE ENERGY LTD of 12 South Charlotte Street, Edinburgh EH2 4AX,
 United Kingdom

5.0 Utility Model Applications Published under Section 42 and Regulation 35

5.1 National Application

(21) KE/U/2018/1058 (22) 23/11/2018
 (73) WANJIRU GATHECHA WAWERU of P. O. BOX 43642-00100 NAIROBI, Kenya
 (72) WANJIRU GATHECHA WAWERU, P. O. BOX 43642-00100 NAIROBI, Kenya
 (54) METHOD FOR PRODUCING A BUILDING BOARD
 (51) E 04B 1/00(2006.01)
 (57) The invention discloses a method for producing building boards or panels which includes use of agro waste and specifically use of rice husks, a binding agent, reducing moisture content of rice husk and binding agent mix, subjecting mix to a heat press and lamination.

(21) KE/U/2020/1437 (22) 06/07/2020
 (73) HERI ONLINE LTD of P. O. BOX 52273-00100, NAIROBI, Kenya
 (72) RITA RAE AKINYI OYIER and PATRICK OWINO OCHIENG
 (54) SERVIETTE DISPENSING BOX
 (51)2016.01: B 65D 83/00(2006.01)
 (57)
 A serviette dispensing box that is also a disposable holder and hygienic dispenser that includes several sides defining a confined space. One side has a t-shaped slot covered by a semitransparent film that has a slit on the bottom of the \ shaped slot. The Slit aligns perpendicularly with the bottom t section ensuring that as the

napkins are dispensed, the rest of the serviettes stay untouched by human hands. The serviette dispensing box allows the user to pull only one serviette at a time without affecting the integrity of the rest of the serviettes.
.....

(21) KE/U/2022/1968 (22) 25/10/2022

(30) Priority: 2022/001946 09/09/2022 KE

(73) GREEN STEM PRODUCTS LTD of P. O. BOX 1369-00606 SARIT CENTRE NAIROBI, Kenya

(72) ANITA SHAH

(74) FRED OTSWONG'O & INTELLECTUAL PROPERTY ASSOCIATES, P. O. BOX 54708-00200, NAIROBI, Kenya

(54) PLANT FIBRE PUNNET AND PROCESS THEREOF

(51) 2016.01:B 65D 85/34

(57)

Disclosed in the present invention a food packaging punnet. The said plant fiber punnet is made of bagasse, banana, wheat/rice straw, bamboo and recycled paper material that are compostable, biodegradable and affordable alternative punnetts for fruits and vegetable food packaging. The plant fiber punnet further comprises fruit and vegetable punnetts made from virgin banana, bagasse wheat/rice straw, bamboo pulp and recycled paper, and food grade corn/cassava starch-based bio adhesive material that are used, bio based water proofing barrier that is used instead of a plastic barrier, elongated shelf life as long as the food product itself and not the life of the planet i.e., thousands of years, and 100% biodegradable and compostable in a backyard compost. Also disclosed is a process of manufacturing plant fiber punnet comprising bagasse, banana, wheat/rice straw, bamboo and recycled paper material and consisting a series of steps.
.....

(21) KE/U/2022/1988 (22) 16/12/2022

(73) THE FUSUION EXPERIENCE KENYA LTD of P.O. BOX 51659-00200 NAIROBI, Kenya

(72) ISRAEL LWANGA, P.O.BOX 51659-00200 NAIROBI, Kenya

(54) GAS CYLINDER WITH A UNIFIED SAFETY VALVE

(51) 2016.01: F 17C 1/00

(57)The present invention relates to a 0.5kg gas cylinder with a unified safety valve comprising of a Collar; foot Ring and Universal Valve and that the said gas cylinder has a burner with an On/Off Knob and a Stand and a regulator further comprising of a Hose Connector; Gas Regulator; On/Off Switch; Release Button; Securing Clip and Gas Cylinder Connector. In the present invention cooking kit solution consists of a 0.5 kg gas cylinder, a single burner with rubber pipe and a regulator. The gas cylinder despite its small size has been fitted with a universal valve that is used in higher density cylinders. This unique feature on this size of cylinder provides higher safety as opposed to the camping valve that is used in small cylinders
.....

(21) KE/U/2022/1991 (22) 20/12/2022

(73) ONFON MEDIA LTD of P.O. BOX 69825-00400 NAIROBI, Kenya

(72) ANDREW QUENTIN BOAZ MBUYA

(54) A SYSTEM AND METHOD FOR MANAGING REAL EASTATE PROPERTIES

(57) The invention discloses a computer implemented system for managing rental properties. In particular, it relates to smart devices such as computer integrated with systems for the creation, integration and implementation of lease agreements and systems that allow refund of rental deposits. The system of the present invention is integrated in a computer or smart device; the said system having a property owner module, a tenant module, financial account module for consolidated funds; the said fund account integrated with various systems such as those for corporates bonds, insurance agencies, commercial banks and the likes for purposes of commercialization of the consolidated fund.
.....

(21) KE/U/2023/2014 (22) 14/02/2023

(73) QIU FAN of P. O. BOX 103104-00600 NAIROBI, Kenya

(72) QIU FAN

(54) CARBONATED BEVERAGE MAKER

(51) A 47J 31/40(2006.01), A 47J 31/00(2006.01)

(57) The present invention relates to Carbonated Beverage maker comprising of the following components: Water filtration system; CO2 system; Syrup system; Carbonation system; Refrigeration system and Distribution system capable of mixing and releasing cooled carbonated water and syrup in a certain proportion through the distribution valve, in a frozen and refreshing carbonated Beverage. It is the principle of the carbonated Beverage maker that after filtering the tap water through the filter or use Bottle water directly, it enters the carbonator and mixes with carbon dioxide gas to form carbonated water wherein the Carbonated water and

syrup are cooled in the Chilled water coil through independent pipes and then the cooled carbonated water and syrup are released by mixing them in a certain proportion through the distribution valve, and become a frozen and refreshing carbonated Beverage.

.....

(21) Application no.: KE/U/2023/2026 (22) Filing Date: 28/02/2023

(51) Int.Cl.2018.01: G 06Q 50/18

(54) Title: LEGAL INFORMATION SYSTEM

(72) Inventors: JACQUELINE KALI, P.O. BOX 44324-00100 NAIROBI, Kenya

(73) Applicant(s): JACQUELINE KALI, P.O. BOX 44324-00100 NAIROBI, Kenya

(57) A legal document information analyzing and output system where the system highlights sections in a legal document that have potential of serious adverse consequences if breached; extracts those sections and provides their explanations in a layman language; and where the system comprises of an application that provides connection and interaction between the user, the databases, the data and information analysis and the system data and information input.

.....

(21) KE/U/2023/2029 (22) 03/03/2023

(73) CHRISTOPHER UVYU MBOLE of P.O. BOX 64434-00620 NAIROBI, Kenya

(72) CHRISTOPHER UVYU MBOLE, P.O. BOX 64434-00620 NAIROBI, Kenya

(54) A location Based System for Conducting Learning Sessions

(57)

The present invention relates generally to training systems and more particularly to GPS enabled training systems and computer medium having augmented reality capabilities for providing training modules. Hence disclosed here is a computer implemented training system that combines physical engagement, conference facilitation, and the learning of new concepts. The said system being capable to integrate a GPS locating device or system and Augmented Reality (AR) system to deliver the training modules.

6.0 Utility Models Renewal

(11)/(21) 160(KE/U/2016/631)

(71) JOMO KENYATTA UNIVERSITY OF AGRICULTURE AND TECHNOLOGY

(24) Registration/application extended up to: 07/04/2024

.....

(11)/(21) 240(KE/U/2017/790)

(71) KINYANJUI DANIEL KANGETHE

(24) Registration/application extended up to: 09/05/2024

.....

(11)/(21) 242(KE/U/2017/816)

(71) JOMO KENYATTA UNIVERSITY OF AGRICULTURE AND TECHNOLOGY (JKUAT)

(24) Registration/application extended up to: 13/06/2024

.....

(11)/(21) 248(KE/U/2017/817)

(71) JOMO KENYATTA UNIVERSITY OF AGRICULTURE AND TECHNOLOGY (JKUAT)

(24) Registration/application extended up to: 13/06/2024

.....

(11)/(21) 165(KE/U/2017/818)

(71) JOMO KENYATTA UNIVERSITY OF AGRICULTURE AND TECHNOLOGY (JKUAT)

(24) Registration/application extended up to: 13/06/2024

.....

(11)/(21) 262(KE/U/2018/1025)

(71) JOMO KENYATTA UNIVERSITY OF AGRICULTURE AND TECHNOLOGY JOSHUA IRUNGU MWAURA

(24) Registration/application extended up to:

.....

(11)/(21) 362(KE/U/2018/1035)

(71) JOMO KENYATTA UNIVERSITY OF AGRICULTURE AND TECHNOLOGY

(24) Registration/application extended up to: 07/04/2024

.....

(11)/(21) 299(KE/U/2019/1233)

(71) JOMO KENYATTA UNIVERSITY OF AGRICULTURE AND TECHNOLOGY

(24) Registration/application extended up to: 07/04/2023

.....

(11)/(21) (KE/U/2019/1282)

(71) KOLIL PHILIP KIBOR

(24) Registration/application extended up to: 04/12/2023

.....

(11)/(21) (KE/U/2019/1282)

(71) KOLIL PHILIP KIBOR

(24) Registration/application extended up to: 04/12/2022

..... (11)/(21) (KE/U/2019/1282) (71) KOLIL PHILIP KIBOR (24) Registration/application extended up to: 04/12/2021	(24) Registration/application extended up to: 07/04/2024
(11)/(21) 290(KE/U/2020/1364) (71) MUTUA STEVE MUTUKU (24) Registration/application extended up to: 20/02/2023	(11)/(21) 366(KE/U/2021/1535) (71) MWANGI RICHARD (24) Registration/application extended up to: 19/03/2023
(11)/(21) 321(KE/U/2020/1470) (71) JOMO KENYATTA UNIVERSITY OF AGRICULTURE AND TECHNOLOGY (JKUAT)	(11)/(21) (KE/U/2022/1918) (71) JOMO KENYATTA UNIVERSITY OF AGRICULTURE AND TECHNOLOGY PAN AFRICAN UNIVERSITY INSTITUTE OF SCIENCES TECHNOLOGY AND INNOVATION (PAUSTI) (24) Registration/application extended up to: 10/06/2024

7.0 Utility Models Registered

7.1 National Utility Models

(11) Registration no.: 413 (45) Date of grant: 01/03/2023
 (21) Application no.: KE/18/01058 (22) Filing Date: 23/11/2018
 (31) Priority:
 (73) Applicant(s): WANJIRU GATHECHA WAWERU, P. O. BOX 43642-00100 NAIROBI, Kenya
 (72) Inventors: WANJIRU GATHECHA WAWERU, P. O. BOX 43642-00100 NAIROBI, Kenya
 (51) Int.Cl.2018.01: E 04B 1/00
 (54) Title: METHOD FOR PRODUCING A BUILDING BOARD
 (57) The invention discloses a method for producing building boards or panels which includes use of agro waste and specifically use of rice husks, a binding agent, reducing moisture content of rice husk and binding agent mix, subjecting mix to a heat press and lamination.

.....
 (11) Registration no.: 414 (45) Date of grant: 01/03/2023
 (21) Application no.: KE/20/01437 (22) Filing Date: 06/07/2020
 (73) Applicant(s): HERI ONLINE LTD, P. O. BOX 52273-00100, NAIROBI, Kenya
 (72) Inventors: RITA RAEL AKINYI OYIER and PATRICK OWINO OCHIENG
 (51) Int.Cl.2018.01: B 65D 83/00
 (54) Title: SERVIETTE DISPENSING BOX
 (57)
 A serviette dispensing box that is also a disposable holder and hygienic dispenser that includes several sides defining a confined space. One side has a t-shaped slot covered by a semitransparent film that has a slit on the bottom of the \ shaped slot. The Slit aligns perpendicularly with the bottom t section ensuring that as the napkins are dispensed, the rest of the serviettes stay untouched by human hands. The serviette dispensing box allows the user to pull only one serviette at a time without affecting the integrity of the rest of the serviettes.

.....
 (11) Registration no.: 415 (45) Date of grant: 02/03/2023
 (21) Application no.: KE/22/01994 (22) Filing Date: 22/12/2022
 (73) Applicant(s): PADMAD FOUNDATIONAL LIMITED, P.O. BOX 142, ELDORET, Kenya
 (72) Inventors: MADHHVI DALAL
 (74) Agent: FREDRICK O. OTSWONG'O, FRED OTSWONG'O & IP ASSOCIATES, P. O. BOX 54708-00200, NAIROBI, Kenya
 (51) Int.Cl.2016.01: A 61F 13/472
 (54) Title: REUSABLE SANITARY PAD
 (57) Disclosed in the present invention is a reusable sanitary pad. The said pad comprises small pads, large pads, liner holders, liners and fastening plastic buttons. The pad is used by women during their menstrual period. The pad has winged back and front outer layers made of 100% knitted cotton material, wherein the

front outer layer further comprises 100% woven cotton kitenge. In addition, the pad has an inner absorbing layer made of natural 100% cotton material configured to absorb the menses liquid, disposed below the inner absorbing layer and having air permeability. When not in use, the said pad has a width of about 70 mm and can be closed by a pair of fastening plastic buttons. Also disclosed is a panty liner of about 3 mm thick and up to about 45 mm.

.....

(11) Registration no.: 416 (45) Date of grant: 02/03/2023

(21) Application no.: KE/23/02003 (22) Filing Date: 13/01/2023

(31) Priority: 2022/1958 27/09/2022 KE

(73) Applicant(s): DROP ACCESS LIMITED, P. O. BOX 2523-00200 NAIROBI, Kenya

(72) Inventors: NORAH MAGERO and JAMES MULATYA

(74) Agent: FREDRICK O. OTSWONG'O, FRED OTSWONG'O & IP ASSOCIATES, P.O. BOX 54708-00200, NAIROBI, Kenya

(51) Int.Cl.2016.01: G 05F 1/67

(54) Title: PORTABLE SOLAR POWERED REFRIGERATOR

(57) Disclosed in the present invention is a portable solar powered refrigerator, comprising a stainless steel exterior body 1 with at least two layers of lid panels 3A, fiberglass interior 2 having a freezing compartment and phase change material or ice packs, telescopic handle 9 A, wheels, inbuilt battery storage 18, solar and AC charging ports with an automatic changeover and selection of power source. The fridge has a temperature sensor 27 and PCB 12A, wherein the PCB is designed to transmit voltage, door status, location and temperature in real-time through Bluetooth, WIFI and GSM, and also send warning alerts. The fridge uses Internet of Things (IoT) using the mobile application 36 and a web platform through which stock management is performed and monitored in real time during transportation of vaccines among other things.

.....

(11) Registration no.: 417 (45) Date of grant: 07/03/2023

(21) Application no.: KE/22/01979 (22) Filing Date: 21/11/2022

(73) Applicant(s): EVANS MUTAMBUKI, LUMUMBA DRIVE, LEDIAN APARTMENT, NAIROBI, Kenya and JACOB MIRU GAKUNGA MOWLEM HEIGHTS, OFF KOMAROCK ROAD, NAIROBI, Kenya

(72) Inventors: EVANS MUTAMBUKI and JACOB MIRU GAKUNGA

(74) Agent: EVANS MUTAMBUKI, P. O. BOX 15472-00100 NAIROBI, Kenya

(51) Int.Cl.2016.01: G 06Q 20/20, G 06Q 30/06, G 07G 1/14, B 62B 5/00, B 62B 3/14

(54) Title: SMART SHOPPING CART

(57) The present invention relates to shopping cart and of smart shopping carts for use at retail points. In particular, it relates to smart shopping carts, smart shopping systems and their usage. It discloses a smart shopping cart to push cashier less checkout in physical stores. The smart shopping cart of the present invention being able to automatically detect items with sensors, cameras, and computer vision algorithms. It allows customers to skip the checkout line in a physical store by charging the smart card attached to their accounts.

.....

(11) Registration no.: 418 (45) Date of grant: 16/03/2023

(21) Application no.: KE/21/01593 (22) Filing Date: 21/09/2021

(73) Applicant(s): ADIDI OCHIENG KENEDY, P. O. BOX 39-40100 KISUMU, Kenya

(72) Inventors: ADIDI OCHIENG KENEDY, P. O. BOX 39-40100 KISUMU, Kenya

(51) Int.Cl.2016.01: G 06Q 20/00

(54) Title: MOBILE MONEY TRANSFER TRACKING SYSTEM

(57) The invention discloses a system that enables a mobile money user to be able to track their expenses by labelling all customer to customer transactions. The invention allows the sender and recipient to receive the same transaction information message.

.....

(11) Registration no.: 419 (45) Date of grant: 21/03/2023

(21) Application no.: KE/21/01589 (22) Filing Date: 12/08/2021

(73) Applicant(s): ALVIN TECHNOLOGIES LIMITED, P. O. BOX 6780-00100 NAIROBI, Kenya

(72) Inventors: WINSTON DAVIS REID

(74) Agent: PETER JOSEPH KEYA, KIBUNGEI & CO. ADVOCATES, P. O. BOX 103082-00101, NAIROBI, Kenya

(51) Int.Cl.2018.01: G 06Q 30/06

(54) Title: A FINANCIAL MANAGEMENT DEVICE AND SYSTEM

(57)

The present invention relates to a device and systems for managing funds. In particular, the invention of this application relates to a device that is embedded with a mobile application capable of tracking user financial transactions and providing information that helps in budgeting. The system for managing finance comprising of

a smart device wherein the smart device is either an android or iOS device, a tracking system and saving tools; the system of the present invention provides an in-app affiliate purchasing option that enable users to make transactions based on their savings and a device integrated with a mobile application that enables a user to manage their funds through tracking their experiences in terms of expenditure.

.....

(11) Registration no.: 420 (45) Date of grant: 22/03/2023

(21) Application no.: KE/23/02011 (22) Filing Date: 08/02/2023

(73) Applicant(s): PACTTECH CONSULTANT GROUP LTD, P.O. BOX 82-20300 NYAHURURU, Kenya

(72) Inventors: ALLAN NJENGA WAIRIMU and JACOB NDIRITU MAINA

(51) Int.Cl.2018.01: G 06Q 50/08

(54) Title: SITE VISIT SYSTEM

(57) A site visit system comprising of; backend application which is also the administration panel; a frontend application which is integrated on the website; input of site visit data and information; uploading site visit videos; and generation of a site visit certificate.

.....

(11) Registration no.: 421 (45) Date of grant: 29/03/2023

(21) Application no.: KE/22/01950 (22) Filing Date: 15/09/2022

(73) Applicant(s): MACIOCIA, PHILIP MATHEW, P.O. BOX 1901-00621, VILLAGE MARKET, NAIROBI, Kenya

(72) Inventors: MACIOCIA, PHILIP MATHEW, P.O. BOX 1901-00621, VILLAGE MARKET, NAIROBI, Kenya

(51) Int.Cl.2016.01: B 09B 3/00, F 23G 5/027

(54) Title: CHAR PRODUCTION FROM PLASTICS

(57)

The present invention relates to the commercial production of char from plastics using industrial pyrolysis technologies. In the present invention that discloses a container and skid- mounted pyrolysis plant that is movable whenever required and can produce char from plastics and that the said char can be used in construction applications such as cement manufacturing whereby it improves tensile strength of the cement. Additionally, the char is a carbon capture option that is eligible for the verification of carbon credits that can be sold on the international voluntary carbon markets.

.....

(11) Registration no.: 422 (45) Date of grant: 29/03/2023

(21) Application no.: KE/22/01969 (22) Filing Date: 02/11/2022

(73) Applicant(s): RASHIK OUMA, P. O. BOX 35337-00100 Nairobi, Kenya

(72) Inventors: RASHIK OUMA, P. O. BOX 35337-00100 Nairobi, Kenya

(51) Int.Cl.2016.01: G 01N 33/497, G 01S 19/01

(54) Title: 4G-WIFI GPS Tracker Integrated with Alcohol Blow and/or with Keypad

(57) This invention discloses 4G-WIFI Tracker integrated with alcohol blow and keypad system. It is characterized by: when a driver enters the car the tracker's alcohol blow carries out an alcohol test. If the alcohol test is passed the buzzer will sound twice and upload the alcohol pass alarm data to the platform and driver can drive the vehicle. If the alcohol test fails, the buzzer will sound thrice and upload the alcohol failure data to the platform and the driver can't drive the vehicle because relay had cut off engine. While the vehicle is in motion depending on user preference the tracker will sound to remind the driver to breath into the alcohol sensor

.....

(11) Registration no.: 423 (45) Date of grant: 29/03/2023

(21) Application no.: KE/22/01990 (22) Filing Date: 20/12/2022

(73) Applicant(s): ANDREW QUENTIN, P. O. BOX 69825-00400 NAIROBI, Kenya

(72) Inventors: ANDREW QUENTIN, P. O. BOX 69825-00400 NAIROBI, Kenya

(51) Int.Cl.:

(54) Title: FINANCIAL MANAGEMENT DEVICE AND SYSTEM

(57) The present invention relates to financial management device and system for saving funds. In particular, smart device having a financial management product, the said used to manage funds as the user executes payments. The system of the present invention is enables or configured to be accessed from various financial institution. In particular, the apparatus having the system of the present invention can access different financial bank accounts integrated with it; the said institution being able to provide access periodically to savings once queried by a user

.....

(11) Registration no.: 424 (45) Date of grant: 29/03/2023

(21) Application no.: KE/22/01991 (22) Filing Date: 20/12/2022
(73) Applicant(s): ONFON MEDIA LTD, P.O. BOX 69825-00400 NAIROBI, Kenya
(72) Inventors: ANDREW QUENTIN BOAZ MBUYA, P.O. BOX 69825-00400 NAIROBI, Kenya
(51) Int.Cl.:

(54) Title: A SYSTEM AND METHOD FOR MANAGING REAL ESTATE PROPERTIES

(57) The invention discloses a computer- implemented system for managing rental properties. In particular, it relates to smart devices such as computer integrated with systems for the creation, integration and implementation of lease agreements and systems that allow refund of rental deposits. The system of the present invention is integrated in a computer or smart device; the said system having a property owner module, a tenant module, financial account module for consolidated funds; the said fund account integrated with various systems such as those for corporates bonds, insurance agencies, commercial banks and the likes for purposes of commercialization of the consolidated fund.

.....

7.2 ARIPO Utility Models granted

8.0 Industrial Design Applications Published Under Section 87 and Regulation 48

NOTICE is given that any person who has grounds of opposition to the Registration of any of the Industrial designs published herein may within sixty (60) days from the date of this Journal, lodge a notice of opposition on form IP 36 (in duplicate) together with a fee of Ksh.5,000/= (local opponent) or US\$ 250 (foreign opponent).

The period of lodging the notice of opposition may be extended by the Managing Director as he deems fit and upon such terms as he may direct. Any request for such extension should be made to the Managing Director to reach him before the expiry of the period allowed.

Formal opposition should not be lodged until after reasonable notice has been given in writing to the applicant to afford him an opportunity of withdrawing his application before the expense of preparing the notice of opposition is incurred. Failure to give such notice will be taken into account in considering any application by an opponent for an order for costs if the opposition is uncontested by the applicant. Representations and samples of the designs advertised herein can be seen at the Patent Registry, Kenya Industrial Property Institute, KIPI Centre, 17 Kabarsiran Avenue, Off Waiyaki Way, Lavington, Nairobi.

8.1 National Applications

((21):2020/2397 (22): 22/12/2020 (30): None
(73): JOMO KENYATTA UNIVERSITY OF AGRICULTURE AND TECHNOLOGY P.O BOX 62000-00200, NAIROBI, Kenya
(74): DIRECTORATE OF INTELLECTUAL PROPERTY MANAGEMENT AND UNIVERSITY- INDUSTRY LIAISON, JKUAT, P.O BOX 62000-00200, NAIROBI, Kenya
(51) International Class (Loc (6)): 12-02 (54): Organic Material Sieving Machine
The novelty of the design resides in the shape and features of the Organic Material Sieving Machine as shown in the aesthetic features and representations.

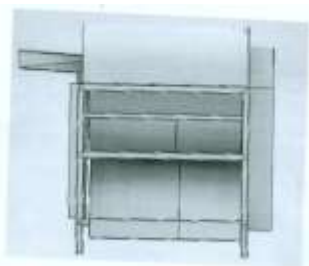

.....

((21):2022/2555 (22): 25/02/2022 (30):29/805,929 31/08/2021 US
(73): THERMOS L.L.C 475 N. MARTINGALE ROAD, SUITE 1100, SHAUMBURG, IL 60173, U.S.A.
(74): Coulson Harney Advocates, P. O. Box 10643-00100, Nairobi, Kenya
(51) International Class (Loc (6)): 09-01 (54): BEVERAGE CONTAINER
The ornamental Design for a lid and container as shown and described.



.....

(21):2022/2557 (22): 25/02/2022 (30):29/805,994 31/08/2021 US
(73): Thermos L.L.C 475 N. Martingale Road, Suite 1100, Schaumburg, IL 60173 , U.S.A.
(74): COULSON HARNEY ADVOCATES, P.O. BOX 10643-00100 NAIROBI, Kenya
(51) International Class (Loc (6)): 09-01 (54): BEVERAGE HOLDER
The ornamental Design for a beverage holder as shown and described.



FIG. 1

.....

(21):2022/2562 (22): 25/02/2022 (30):29/806,160 01/09/2021 US
(73): THERMOS LLC 475 N. MARTINGALE ROAD, SUITE 1100, SCHAU MBURG, IL 60173, U.S.A.
(74): Coulson Harney Advocates, P. O. Box 10643-00100, Nairobi
(51) International Class (Loc (6)): 09-01 (54): BEVERAGE CONTAINER
The ornamental Design for a beverage container as shown and described.



.....

(21):2022/2647 (22): 09/11/2022 (30): None
(73): WATERVALE INVESTMENTS LIMITED, P. O. BOX 00505-21951 Nairobi, Kenya
(74): CATHERINE NYAMBURA KARANJA, P. O. BOX 2318-00606 SARIT CENTER NAIROBI, Kenya
(51) International Class (Loc (6)): 06-13 (54): MATTRESS
The features of the design for which novelty is claimed are the pattern and ornamentation of the article as shown in the representations.
All wordings appearing on the design are disclaimed.



.....

((21):2023/2690 (22): 21/02/2023 (30): None
(73): Huming PVC Company Limited, P.O. BOX 1132-00242 KITENGELA, Kenya (74):
(51) International Class (Loc (6)): 06-06 (54): Decorative edgings for furniture
The features for which novelty is claimed are the surface pattern and ornamentation of decorative edgings for furniture as substantially shown in the representations.



.....

((21):2023/2691 (22): 21/02/2023 (30): None
(73): Huming PVC Company Limited, P.O. BOX 1132-00242 KITENGELA, Kenya (74):
(51) International Class (Loc (6)): 06-06 (54): Decorative edgings for furniture
The features for which novelty is claimed are the surface pattern and ornamentation of decorative edgings for furniture as substantially shown in the representations.



.....

((21):2023/2692 (22): 21/02/2023 (30): None
(73): Huming PVC Company Limited, P.O. BOX 1132-00242 KITENGELA, Kenya (74):
(51) International Class (Loc (6)): 06-06 (54): Decorative edgings for furniture
The features for which novelty is claimed are the surface pattern and ornamentation of decorative edgings for furniture as substantially shown in the representations.



.....
((21):2023/2693 (22): 21/02/2023 (30): None
(73): Huming PVC Company Limited P.O. BOX 1132-00242 KITENGELA, Kenya (74):
(51) International Class (Loc (6)): 06-06 (54): Decorative edgings for furniture
The features for which novelty is claimed are the surface pattern and ornamentation of decorative edgings for furniture as substantially shown in the representations.



.....
((21):2023/2694 (22): 21/02/2023 (30): None
(73): Huming PVC Company Limited, P.O. BOX 1132-00242 KITENGELA, Kenya (74):
(51) International Class (Loc (6)): 06-06 (54): Decorative edgings for furniture
The features for which novelty is claimed are the surface pattern and ornamentation of decorative edgings for furniture as substantially shown in the representations.



.....
((21):2023/2695 (22): 21/02/2023 (30): None
(73): Huming PVC Company Limited P.O. BOX 1132-00242 KITENGELA, Kenya (74):
(51) International Class (Loc (6)): 06-06 (54): Decorative edgings for furniture
The features for which novelty is claimed are the surface pattern and ornamentation of decorative edgings for furniture as substantially shown in the representations.



.....
((21):2023/2696 (22): 21/02/2023 (30): None
(73): HUMING PVC COMPANY LIMITED, P.O. BOX 1132-00242 KITENGELA, Kenya (74):
(51) International Class (Loc (6)): 06-06 (54): DECORATIVE EDGINGS FOR FURNITURE
The features for which novelty is claimed are the surface pattern and ornamentation of decorative edgings for furniture as substantially shown in the representations.



.....
((21):2023/2697 (22): 21/02/2023 (30): None
(73): HUMING PVC COMPANY LIMITED, P.O. BOX 1132-00242 KITENGELA, Kenya (74):
(51) International Class (Loc (6)): 06-06 (54): DECORATIVE EDGINGS FOR FURNITURE

The features for which novelty is claimed are the surface pattern and ornamentation of decorative edgings for furniture as substantially shown in the representation



.....

((21):2023/2698 (22): 21/02/2023 (30): None

(73): HUMING PVC COMPANY LIMITED, P.O. BOX 1132-00242 KITENGELA, Kenya (74):

(51) International Class (Loc (6)): 06-06 (54): DECORATIVE EDGINGS FOR FURNITURE

The features for which novelty is claimed are the surface pattern and ornamentation of decorative edgings for furniture as substantially shown in the representation.



.....

((21):2023/2699 (22): 01/03/2023 (30): None

(73): PLANET CHIKA CHIKA LTD, P.O.BOX 2083-80100 MOMBASA, Kenya (74):

(51) International Class (Loc (6)): 09-01 (54): BOTTLE

THE FEATURES OF THE DESIGN FOR WHICH NOVELTY IS CLAIMED ARE IN THE GENRAL SHAPE, CONFIGURATION, ORNAMENTATION AND THE PATTERN AS SHOWN IN THE REPRESENTATIONS.

WE DISCLAIM ALL THE WRITING APPEARING ON THE DESIGN BOTTLE AS A WHOLE



.....

8.2 Corrigenda

The images of the Industrial designs applications to appear as below;

((21):2021/2476 (22): 29/04/2021 (30): None
(73): NILESH D J DODHIA, P. O. BOX 48158-00100 NAIROBI (74):
(51) International Class (Loc (6)):13-2021.01.07.07 (54): BUCKET

The features of the design for which novelty is claimed are the shape and the configuration of the article as shown in the representation.

All wordings appearing in the design are disclaimed

VIEW OF COMPLETE BUCKET



((21):2021/2477 (22): 29/04/2021 (30): None
(73): NILESH D J DODHIA, P. O. BOX 48158-00100 NAIROBI (74): ,
(51) International Class (Loc (6)): 13-2021.01.07.07 (54): BUCKET

The features of the design for which novelty is claimed are the shape and the configuration of the article as shown in the representation.

All wordings appearing in the design are disclaimed

VIEW OF COMPLETE BUCKET



((21):2021/2478 (22): 29/04/2021 (30): None
(73): NILESH D J DODHIA, P. O. BOX 48158-00100 NAIROBI (74):
(51) International Class (Loc (6)): 13-2021.01.07.07 (54): BUCKET

The features of the design for which novelty is claimed are the shape and the configuration of the article as shown in the representation.

All wordings appearing in the design are disclaimed

PERSPECTIVE VIEW



.....
The images of the Industrial designs applications to appear as below;

(21):2022/2614 (22): 08/08/2022 (30):008857460-0001 10/02/2022 DE
(73): Condor Flugdienst GmbH An der Gehespitz 50 D-63263 Neu-Isenburg, Germany **(74):** Chebet & Co. Advocates, 3rd floor, Jacaranda Bldg, General Mathenge Road, Nairobi, Kenya
(51) International Class (Loc (6)): 12-07 and 32-00 **(54):** AEROPLANES

The novelty of the design (as covered in Community Design number 008857460-0001 filed at the European Union Intellectual Property Office) lies in the novel visual features of the pattern and composition of colour stripes as applied to the body of an aeroplane and to the ends of the wings, as shown in the representations, which pattern and composition gives a special appearance to the aeroplane. In the representations, the dotted/broken lines denote and delineate the outer limits/edges of the design, and the parts of the aeroplane not covered by the pattern and composition of colour stripes fall outside the scope of protection sought, do not form part of the design and are disclaimed



.....
(21):2022/2615 (22): 08/08/2022 (30):008857460-002 10/02/2022 DE
(73): Condor Flugdienst GmbH An der Gehespitz 50 D-63263 Neu-Isenburg, Germany **(74):** Chebet & Co. Advocates, 3rd floor, Jacaranda Bldg, General Mathenge Road Nairobi, Kenya
(51) International Class (Loc (6)): 12-07 and 32-00 **(54):** AEROPLANES

The novelty of the design (as covered in Community Design number 008857460-0002 filed at the European Union Intellectual Property Office) lies in the novel visual features of the pattern and composition of colour stripes as applied to the body of an aeroplane and to the ends of the wings, as shown in the representations, which pattern and composition gives a special appearance to the aeroplane. In the representations, the dotted/broken lines denote and delineate the outer limits/edges of the design, and the parts of the aeroplane not covered by the pattern and composition of colour stripes fall outside the scope of protection sought, do not form part of the design and are disclaimed.



.....
(21):2022/2616 (22): 08/08/2022 (30):008857460-0003 10/02/2022 DE
(73): Condor Flugdienst GmbH An der Gehespitz 50 D-63263 Neu-Isenburg, Germany
(74): Chebet & Co. Advocates, 3rd floor, Jacaranda Bldg. General Mathenge Road Nairobi, Kenya
(51) International Class (Loc (6)): 12-07 and 32-00 **(54):** AEROPLANES

The novelty of the design (as covered in Community Design number 008857460-0003 filed at the European Union Intellectual Property Office) lies in the novel visual features of the pattern and composition of colour stripes as applied to the body of an aeroplane and to the ends of the wings, as shown in the

representations, which pattern and composition gives a special appearance to the aeroplane. In the representations, the dotted/broken lines denote and delineate the outer limits/edges of the design, and the parts of the aeroplane not covered by the pattern and composition of colour stripes fall outside the scope of protection sought, do not form part of the design and are disclaimed.



.....
((21):2022/2617 (22): 08/08/2022 (30):008857460-0004 10/02/2022 DE
(73): Condor Flugdienst GmbH An der Gehespitz 50 D-63263 Neu-Isenburg, Germany (74): Chebet & Co. Advocates, 3rd floor, Jacaranda Bldg, General Mathenge Road Nairobi, Kenya
(51) International Class (Loc (6)): 12-07 (54): AEROPLANES

The novelty of the design (as covered in Community Design number 008857460-0004 filed at the European Union Intellectual Property Office) lies in the novel visual features of the pattern and composition of colour stripes as applied to the body of an aeroplane and to the ends of the wings, as shown in the representations, which pattern and composition gives a special appearance to the aeroplane. In the representations, the dotted/broken lines denote and delineate the outer limits/edges of the design, and the parts of the aeroplane not covered by the pattern and composition of colour stripes fall outside the scope of protection sought, do not form part of the design and are disclaimed.



.....
((21):2022/2618 (22): 08/08/2022 (30):008857460-0005 10/02/2022 DE
(73): Condor Flugdienst GmbH An der Gehespitz 50 D-63263 Neu-Isenburg, Germany (74): Chebet & Co. Advocates, 3rd floor, Jacaranda Bldg, General Mathenge Road Nairobi, Kenya
(51) International Class (Loc (6)): 12-07 (54): AEROPLANES

The novelty of the design (as covered in Community Design number 008857460-0005 filed at the European Union Intellectual Property Office) lies in the novel visual features of the pattern and composition of colour stripes as applied to the body of an aeroplane and to the end of the wings, as shown in the representations, which pattern and composition gives a special appearance to the aeroplane. In the representations, the dotted/broken lines denote and delineate the outer Limits/edges of the design, and the parts of the aeroplane not covered by the pattern and composition of colour stripes fall outside the scope of protection sought, do not form part of the design and are disclaimed.



.....
((21):2022/2619 (22): 08/08/2022 (30):008857460-0006 10/02/2022 DE
(73): Condor Flugdienst GmbH An der Gehespitz 50 D-63263 Neu-Isenburg, Germany
(74): Chebet & Co. Advocates, 3rd floor, Jacaranda Bldg. General Mathenge Road Nairobi, Kenya
(51) International Class (Loc (6)): 12-07 (54): AEROPLANES

The novelty of the design (as covered in Community Design number 008857460-0006 filed at the European Union Intellectual Property Office) lies in the novel visual features of the pattern and composition of colour stripes as applied to the body of an aeroplane and to the ends of the wings, as shown in the representations, which pattern and composition gives a special appearance to the aeroplane. In the

representations, the dotted/broken lines denote and delineate the outer limits/edges of the design, and the parts of the aeroplane not covered by the pattern and composition of colour stripes fall outside the scope of protection sought, do not form part of the design and are disclaimed.

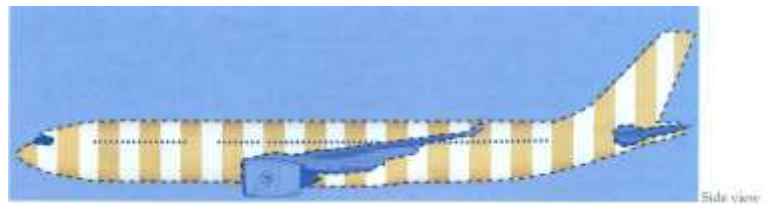

8.2. ARIPO Applications Designating Kenya

(21) Application No.:AP/D/2021/1603

(22) Filing date: 23/12/2021

(30) Priority:202130670046.5 13/10/2021 CN

(51) Classification:14-03

(54) Article to which design is applied: TELEVISION

(73) Applicant: SHENZHEN TRANSSION HOLDINGS CO., LTD. Room 1702-1703, Desay Building, No.9789 Shennan Road, Hi-tech Park, Nanshan District, Shenzhen, China

(74) Agent/address of service: INVENTA MOZAMBIQUE, LDA., Av. 25 de Setembro, 1821 Maputo, Mozambique

The feature for which novelty is claimed is the shape of a television as substantially shown by the graphic representations.

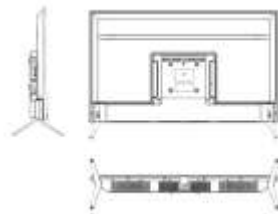

(21) Application No.:AP/D/2021/1607

(22) Filing date: 29/12/2021

(30) Priority:

(51) Classification:13-03

(54) Article to which design is applied: INSULATOR ARRANGEMENT TO SUPPORT A FUSE CUT-OUT ASSEMBLY AND/OR A SURGE PROTECTION ASSEMBLY OF AN ELECTRICAL PROTECTION ASSEMBLY

(73) Applicant: THE TRUSTEES FOR THE TIME BEING OF THE LIVE LINE INTERNATIONAL TRUST Acclaim House, 12 Mount Havelock, 1M1 2QG Douglas, Isle of Man, ISLE OF MAN

(74) Agent/address of service: ADAMS AND ADAMS MOZAMBIQUE, Rua Estevão Ata-de, #20, R/C Bairro da Sommerschield, Maputo, Mozambique



Three-dimensional view
Figure 1

- (21) Application No.:AP/D/2022/1678
- (22) Filing date: 23/05/2022
- (30) Priority:6177528 24/11/2021 GB
- (51) Classification:07-10
- (54) Article to which design is applied: CHILLER
- (73) Applicant: MARS, INCORPORATED 6885 Elm Street, McLean, Virginia 22101-3883, United States of America
- (74) Agent/address of service: ADAMS AND ADAMS MOZAMBIQUE, Rua Estevão Ataã-de, #20, R/C Bairro da Sommerschild, Maputo, Mozambique

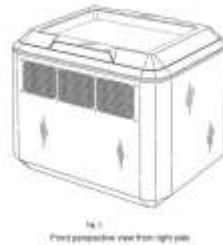

-
- (21) Application No.:AP/D/2022/1687
 - (22) Filing date: 20/06/2022
 - (30) Priority:
 - (51) Classification:20-03
 - (54) Article to which design is applied: ADVERTISING PANEL
 - (73) Applicant: KARANJA George Ragui, P. O. Box 9712-00200 Nairobi, Kenya
 - (74) Agent/address of service: KARANJA George Ragui, P. O. Box 9712-00200 Nairobi, Kenya
- The features for which novelty is claimed are the features of shape, configuration, and pattern as shown in the drawings.

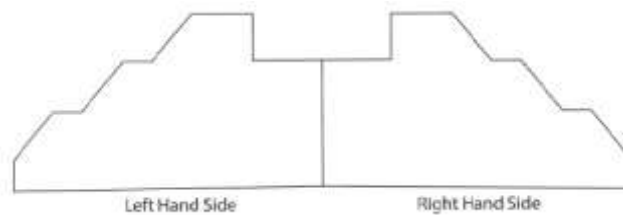

-
- (21) Application No.:AP/D/2022/1721
 - (22) Filing date: 18/11/2022
 - (30) Priority:009030158-0002 19/05/2022 EU
 - (51) Classification:07-02
 - (54) Article to which design is applied: AIR FRYER
 - (73) Applicant: PHILIPS DOMESTIC APPLIANCES HOLDING B.V., High Tech Campus 42, 5656AE Eindhoven, The Netherlands
 - (74) Agent/address of service: HAMILTON HARRISON & MATHEWS ADVOCATES, 1st Floor, Delta Office Suites, Block A, Off Waiyaki Way, Muthangari, P.O. Box 30333 Nairobi - 00100, Kenya



.....

- (21) Application No.:AP/D/2022/1730
- (22) Filing date: 09/12/2022
- (30) Priority:202230575615.2 01/09/2022 CN
- (51) Classification:14-03
- (54) Article to which design is applied: MOBILE TELEPHONE
- (73) Applicant: SHENZHEN TRANSSION HOLDINGS CO., LTD., Room 1702-1703, Desay Building, No.9789 Shennan Road, Hi-tech Park, Nanshan District, Shenzhen
- (74) Agent/address of service: INVENTA MOZAMBIQUE, LDA., Av. 25 de Setembro, 1821 Maputo, Mozambique



.....

- (21) Application No.:AP/D/2023/1736
- (22) Filing date: 09/01/2023
- (30) Priority:2022502918 08/01/2022 RU
- (51) Classification:09-03
- (54) Article to which design is applied: PACKAGING CONTAINERS FOR MEDICINAL PRODUCTS
- (73) Applicant: JOINT STOCK COMPANY "BIOCAD" 198515, Saint Petersburg, vn. ter. g. poselok Strelna, p. Strelna, ul. Svyazi, d. 38, str. 1, pomeshch. 89, Russian Federation
- (74) Agent/address of service: HONEY & BLANCKENBERG, 200 Herbert Chitepo Avenue, Harare, Zimbabwe



THREE DIMENSIONAL VIEW FROM ABOVE OF THE PACKAGING CONTAINER IN AN ISOMETRIC STATE

.....

- (21) Application No.:AP/D/2023/1737
- (22) Filing date: 09/01/2023
- (30) Priority:2022502918 08/07/2022 RU
- (51) Classification:09-03
- (54) Article to which design is applied: PACKAGING CONTAINERS FOR MEDICINAL PRODUCTS
- (73) Applicant: JOINT STOCK COMPANY "BIOCAD" 198515, Saint Petersburg, vn. ter. g. poselok Strelna, p. Strelna, ul. Svyazi, d. 38, str. 1, pomeshch. 89, Russian Federation
- (74) Agent/address of service: HONEY & BLANCKENBERG, 200 Herbert Chitepo Avenue, Harare, Zimbabwe



THREE-DIMENSIONAL VIEW FROM ABOVE, OF THE PACKAGING CONTAINER IN AN ASSEMBLED STATE

.....

- (21) Application No.:AP/D/2023/1739
- (22) Filing date: 09/01/2023
- (30) Priority:2022502918 08/07/2022 RU
- (51) Classification:09-03
- (54) Article to which design is applied: PACKAGING CONTAINERS FOR MEDICINAL PRODUCTS
- (73) Applicant: JOINT STOCK COMPANY "BIOCAD" 198515, Saint Petersburg, vn. ter. g. poselok Strelna, p. Strelna, ul. Svyazi, d. 38, str. 1, pomesch. 89, Russian Federation
- (74) Agent/address of service: HONEY & BLANCKENBERG, 200 Herbert Chitepo Avenue, Harare, Zimbabwe



THREE-DIMENSIONAL VIEW FROM ABOVE, OF THE PACKAGING CONTAINER IN AN ASSEMBLED STATE

.....

- (21) Application No.:AP/D/2023/1740
- (22) Filing date: 09/01/2023
- (30) Priority:2022502919 08/07/2022 RU
- (51) Classification:09-03
- (54) Article to which design is applied: PACKAGING CONTAINERS FOR MEDICINAL PRODUCTS
- (73) Applicant: JOINT STOCK COMPANY "BIOCAD" 198515, Saint Petersburg, vn. ter. g. poselok Strelna, p. Strelna, ul. Svyazi, d. 38, str. 1, pomesch. 89, Russian Federation
- (74) Agent/address of service: HONEY & BLANCKENBERG, 200 Herbert Chitepo Avenue, Harare, Zimbabwe



THREE-DIMENSIONAL VIEW FROM ONE END OF THE PACKAGING CONTAINER IN AN ASSEMBLED STATE

.....

- (21) Application No.:AP/D/2023/1741
- (22) Filing date: 09/01/2023
- (30) Priority:2022502919 08/07/2022 RU
- (51) Classification:09-03
- (54) Article to which design is applied: PACKAGING CONTAINERS FOR MEDICINAL PRODUCTS
- (73) Applicant: JOINT STOCK COMPANY "BIOCAD" 198515, Saint Petersburg, vn. ter. g. poselok Strelna, p. Strelna, ul. Svyazi, d. 38, str. 1, pomesch. 89, Russian Federation
- (74) Agent/address of service: HONEY & BLANCKENBERG, 200 Herbert Chitepo Avenue, Harare, Zimbabwe



.....

- (21) Application No.:AP/D/2023/1743
- (22) Filing date: 09/01/2023
- (30) Priority:2022502919 08/07/2022 RU
- (51) Classification:09-03
- (54) Article to which design is applied: PACKAGING CONTAINERS FOR MEDICINAL PRODUCTS
- (73) Applicant: JOINT STOCK COMPANY "BIOCAD" 198515, Saint Petersburg, vn. ter. g. poselok Strelna, p. Strelna, ul. Svyazi, d. 38, str. 1, pomeshch. 89, Russian Federation
- (74) Agent/address of service: HONEY & BLANCKENBERG, 200 Herbert Chitepo Avenue, Harare, Zimbabwe



.....

- (21) Application No.:AP/D/2023/1746
- (22) Filing date: 23/01/2023
- (30) Priority:009096902-0001 26/07/2022 EU
- (51) Classification:13-03
- (54) Article to which design is applied: SWITCH FOR ELECTRICAL CIRCUIT
- (73) Applicant: LEGRAND SNCLEGRAND FRANCE 128 avenue du MarÃ©chal de Lattre-de-Tassigny, 87000 Limoges, France, France and 128 avenue du MarÃ©chal de Lattre-de-Tassigny, 87000 Limoges, France
- (74) Agent/address of service: FISHER CORMACK & BOTHA, P. O. Box 74, Blantyre, Malawi



.....

- (21) Application No.:AP/D/2023/1747
- (22) Filing date: 23/01/2023
- (30) Priority:009096902-0002 26/07/2022 EU
- (51) Classification:13-03
- (54) Article to which design is applied: SWITCH FOR ELECTRICAL CIRCUIT
- (73) Applicant: LEGRAND SNCLEGRAND FRANCE 128 avenue du MarÃ©chal de Lattre-de-Tassigny, 87000 Limoges, France and 128 avenue du MarÃ©chal de Lattre-de-Tassigny, 87000 Limoges, France
- (74) Agent/address of service: FISHER CORMACK & BOTHA, P. O. Box 74, Blantyre, Malawi

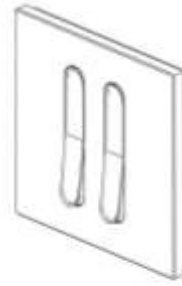

Perspective view

.....

(21) Application No.:AP/D/2023/1748

(22) Filing date: 23/01/2023

(30) Priority:009096902-0003 26/07/2022 EU

(51) Classification:13-03

(54) Article to which design is applied: SWITCH FOR ELECTRICAL CIRCUIT

(73) Applicant: LEGRAND SNCLEGRAND FRANCE 128 avenue du Mar  chal de Lattre-de-Tassigny, 87000 Limoges, France and 128 avenue du Mar  chal de Lattre-de-Tassigny, 87000 Limoges, France

(74) Agent/address of service: FISHER CORMACK & BOTHA, P. O. Box 74, Blantyre, Malawi

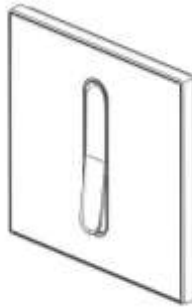

Perspective view

.....

(21) Application No.:AP/D/2023/1749

(22) Filing date: 23/01/2023

(30) Priority:009096902-0005 26/07/2022 EU

(51) Classification:13-03

(54) Article to which design is applied: SWITCH FOR ELECTRICAL CIRCUIT

(73) Applicant: LEGRAND SNCLEGRAND FRANCE 128 avenue du Mar  chal de Lattre-de-Tassigny, 87000 Limoges, France and 128 avenue du Mar  chal de Lattre-de-Tassigny, 87000 Limoges, France

(74) Agent/address of service: FISHER CORMACK & BOTHA, P. O. Box 74, Blantyre, Malawi

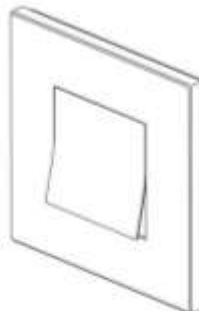

Perspective view

.....

(21) Application No.:AP/D/2023/1750

(22) Filing date: 23/01/2023

(30) Priority:009096902-0004 26/07/2022 EU

(51) Classification:13-03

(54) Article to which design is applied: SWITCH FOR ELECTRICAL CIRCUIT

(73) Applicant: LEGRAND SNCLEGRAND FRANCE 128 avenue du Mar  chal de Lattre-de-Tassigny, 87000 Limoges, France and 128 avenue du Mar  chal de Lattre-de-Tassigny, 87000 Limoges, France
(74) Agent/address of service: FISHER CORMACK & BOTHA, P. O. Box 74, Blantyre, Malawi

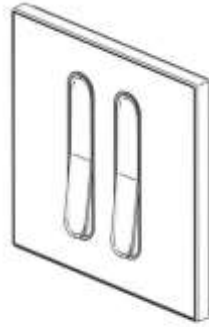

Perspective view

.....

(21) Application No.:AP/D/2023/1751

(22) Filing date: 23/01/2023

(30) Priority:009096902-0006 26/07/2022 EU

(51) Classification:13-03

(54) Article to which design is applied: SWITCH FOR ELECTRICAL CIRCUIT

(73) Applicant: LEGRAND SNCLEGRAND FRANCE 128 avenue du Mar  chal de Lattre-de-Tassigny, 87000 Limoges, France, and 128 avenue du Mar  chal de Lattre-de-Tassigny, 87000 Limoges, France

(74) Agent/address of service: FISHER CORMACK & BOTHA, P. O. Box 74, Blantyre, Malawi

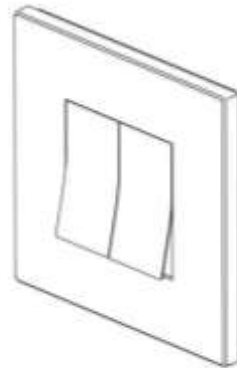

Perspective view

.....

9.0 Registered Industrial Designs

9.1 National Industrial Designs

(11): 1565 (45): 01/03/2023 (21): 2019/2024 (22): 13/05/2019 (30): (51): (Loc (6)):09-01 (54): BOTTLE (73): PREMIER FOOD INDUSTRIES LIMITED, P.O. BOX 41476-00100, NAIROBI, Kenya (74):

The novelty of the bottle design resides in the shape, pattern, configuration and contours as shown in the representations.

All wordings appearing in the bottle do not form part of the design and are disclaimed.



.....

(11): 1566 (45): 01/03/2023 (21): 2019/2025 (22): 13/05/2019 (30): (51): (Loc (6)):09-01 (54): BOTTLE (73): PREMIER FOOD INDUSTRIES LIMITED, P.O. BOX 41476-00100, NAIROBI, Kenya (74):
The novelty of the bottle design resides in the shape, pattern, configuration and contours as shown in the representations.

All wordings appearing in the bottle do not form part of the design and are disclaimed.



.....

(11): 1567 (45): 16/03/2023 (21): 2022/2655 (22): 29/11/2022 (30): (51): (Loc (6)):02-02 (54): BRIDAL DRESS (73): FARMTUAL INVESTMENTS LIMITED, P. O. BOX 28781-00100 NAIROBI, Kenya (74):
The features for which novelty is claimed are the shape, configuration and pattern of a bridal dress as shown in the representations.



.....

(11): 1568 (45): 16/03/2023 (21): 2022/2656 (22): 29/11/2022 (30): (51): (Loc (6)):02-02 (54): BRIDAL DRESS (73): FARMTUAL INVESTMENTS LIMITED, P. O. BOX 28781-00100 NAIROBI, Kenya (74):
The features for which novelty is claimed are the shape, configuration and pattern of a bridal dress as shown in the representations.



.....

(11): 1569 (45): 16/03/2023 (21): 2022/2657 (22): 29/11/2022 (30): (51): (Loc (6)):02-02 (54): BRIDAL DRESS (73): FARMTUAL INVESTMENTS LIMITED, P. O. BOX 28781-00100 NAIROBI, Kenya (74):
The features for which novelty is claimed are the shape, configuration and pattern of a bridal dress as shown in the representations.



.....

(11): 1570 (45): 16/03/2023 (21): 2022/2658 (22): 29/11/2022 (30): (51): (Loc (6)):02-02 (54): BRIDAL DRESS (73): FARMTUAL INVESTMENTS LIMITED P. O. BOX 28781-00100 NAIROBI, Kenya (74):
The features for which novelty is claimed are the shape, configuration and pattern of a bridal dress as shown in the representations.



.....

(11): 1571 (45): 16/03/2023 (21): 2022/2659 (22): 29/11/2022 (30): (51): (Loc (6)):02-02 (54): BRIDAL DRESS (73): FARMTUAL INVESTMENT LIMITED, P. O. BOX 28781-00100 NAIROBI, Kenya (74):

The features for which novelty is claimed are the shape, configuration and pattern of a bridal dress as shown in the representations.



.....

(11): 1572 (45): 16/03/2023 (21): 2022/2660 (22): 29/11/2022 (30): (51): (Loc (6)):02-02 (54): BRIDAL DRESS (73): FARMTUAL INVESTMENT LIMITED, P. O. BOX 28781-00100 NAIROBI, Kenya (74):
The features for which novelty is claimed are the shape, configuration and pattern of a bridal dress as shown in the representations.



.....

(11): 1573 (45): 16/03/2023 (21): 2022/2661 (22): 29/11/2022 (30): (51): (Loc (6)):02-02 (54): BRIDAL DRESS (73): FARMTUAL INVESTMENT LIMITED, P. O. BOX 28781-00100 NAIROBI, Kenya (74):
The features for which novelty is claimed are the shape, configuration and pattern of a bridal dress as shown in the representations.



.....

(11): 1574 (45): 16/03/2023 (21): 2022/2662 (22): 29/11/2022 (30): (51): (Loc (6)):02-02 (54): BRIDAL DRESS (73): FARMTUAL INVESTMENT LIMITED, P. O. BOX 28781-00100 NAIROBI, Kenya (74): The features for which novelty is claimed are the shape, configuration and pattern of a bridal dress as shown in the representations.



.....

(11): 1575 (45): 22/03/2023 (21): 2021/2538 (22): 30/09/2021 (30):29/776,669 31/03/2021 US (51): (Loc (6)):07-01 (54): LID WITH STRAW (73): THERMOS L.L.C. 475 N., Martingale Road, Suite 1100, Schaumburg, Illinois 60173, U.S.A. (74): Coulson Harney Advocates, P.O. Box 10643-00100 Nairobi, Kenya The ornamental design for a lid with straw, as shown and described.



.....

(11): 1576 (45): 22/03/2023 (21): 2021/2550 (22): 29/12/2021 (30):202130427414.3 07/07/2021 CN (51): (Loc (6)):13-03 and 26-99 (54): SWITCH SOCKET (73): LEGRAND INTELLIGENT ELECTRICAL (HUIZHOU) CO., LTD., Factory Bldg, BI-B3, No. 39 East Hechang No. 6 Road, Zhongkai Hi-tech Industrial Development Park, HuiZhou, GuangDong, 516006, China (74): J.K. MUCHAE & COMPANY ADVOCATES, P. O. BOX 60664-00200, NAIROBI, Kenya The design relates to a switch Socket and features of the design for which protection id claimed are those of shape and/or configuration, and/or pattern, but the features shown in the broken lines are illustrative purposes only, do not form part of the design and are disclaimed.



.....

(11): 1577 (45): 23/03/2023 (21): 2022/2596 (22): 15/06/2022 (30): (51): (Loc (6)):09-05 (54): BAG (73): BURUK GENERAL TRADING CO LTD, P. O. BOX 23082-00100, ATLANTIS BUSINESS PARK B3, NAIROBI, Kenya (74): The features for which novelty is claimed are the pattern and ornamentation of a bag as shown in the representations.

All the wordings and the logo appearing in the design do not form part of the design and are disclaimed.



Fig. 1 Front view

.....

9.2 ARIPO Designs

(11) Registration No.: 1367

(45) Registration date: 27/02/2023

(21) Application No.: 2019/1359

(22) Filing date: 02/01/2019

(30)Priority: F2018/01032 02/08/2018 ZA

(51): Classification:25-01

(54) Article to which design is applied: MULTI-FUNCTIONAL BEAM FOR FORMWORK, FALSEWORK AND SCAFFOLDING RELATED APPLICATIONS

(73) Owner: WACO Africa (Pty) Ltd t/a FORMSCAFF 181 Barbara Road, ELANDSFONTEIN, Johannesburg, 1401, Gauteng, South Africa

(74) Agent/ Address for service: ADAMS AND ADAMS MOZAMBIQUE, Rua Estevão Ata-de, #20, R/C, Bairro da Sommerschild, Maputo, Mozambique

The features of the design for which protection is claimed include the shape and/or configuration of a beam for formwork, falsework and scaffolding related applications, substantially as illustrated in the accompanying representations



.....

(11) Registration No.: 1150

(45) Registration date: 26/10/2020

(21) Application No.: 2020/1442

(22) Filing date: 28/01/2020

(30) Priority:

(51): Classification: 09-03

(54) Article to which design is applied: A CONTAINER FOR CHEMICALS

(73) Owner: CONTROL CHEMICALS (PTY) LTD 70 Thirteenth Road, Kew, Johannesburg, 2090, Gauteng, South Africa

(74) Agent/ Address for service: ADAMS AND ADAMS MOZAMBIQUE, Rua Estevão Ata-de, #20, R/C Bairro da Sommerschild, Maputo, Mozambique



Three-dimensional view

.....

(11) Registration No.: 1279

(45) Registration date: 18/08/2022

(21) Application No.: 2021/1553

(22) Filing date: 21/06/2021

(30) Priority: 008364681-0001 22/12/2020 EM

(51): Classification:

(54) Article to which design is applied: SOLAR LIGHTS

(73) Owner: NAMENE SOLAR LIGHTS LIMITED 51 Holland Street, London W8 7JB, United Kingdom

(74) Agent/ Address for service: GALLOWAY & COMPANY, P. O. Box A761, Avondale, Harare, Zimbabwe

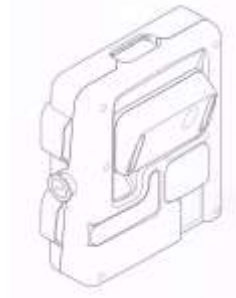

.....

(11) Registration No.: 1368

(45) Registration date: 27/02/2023

(21) Application No.: 2021/1560

(22) Filing date: 11/08/2021

(30) Priority: 339101-001 13/02/2021 IN

(51): Classification: 12-14

(54) Article to which design is applied: CARGO LOAD DECK VEHICLE

(73) Owner: TVS MOTOR COMPANY LIMITED Chaitanya, No.12, Khader Nawaz Khan Road, Nungambakkam, Chennai 600 006, India

(74) Agent/ Address for service: CLAIRWOOD CHAMBERS, 38 Clairwood Road, Alexandra Park, Harare, Zimbabwe

Novelty resides in the entire shape and configuration of the Cargo Load deck vehicle illustrated.

No claim is made by virtue of this registration in respect of any mechanical or other action of the mechanism whatsoever or in respect of any mode or principle of construction of the article.

No claim is made by virtue of registration in respect of any extraneous matter not forming part of the design as illustrated.

No claim is made by virtue of the registration to any right to the exclusive use of the words, letters, numerals, flags, crowns, arms or other trade marks etc. appearing in the Cargo Load deck vehicle as illustrated



FRONT LEFT PERSPECTIVE VIEW

.....

(11) Registration No.: 1275

(45) Registration date: 15/07/2022

(21) Application No.: 2021/1576

(22) Filing date: 06/09/2021

(30) Priority: 202130155533.8 23/03/2021 CN

(51): Classification:

(54) Article to which design is applied: MOBILE PHONE

(73) Owner: SHENZHEN TRANSSION HOLDINGS CO., LTD. Room 1702-1703, Desay Building, No.9789 Shennan Road, Hi-tech Park, Nanshan District, Shenzhen, China

(74) Agent/ Address for service: INVENTA MOZAMBIQUE, LDA., Av. 25 de Setembro, 1821 Maputo, Mozambique

The features for which novelty is claimed are the shape of a mobile phone as shown in the representations



.....

(11) Registration No.: 1291

(45) Registration date: 16/09/2022

(21) Application No.: 2021/1584

(22) Filing date: 02/11/2021

(30) Priority: 202112651 06/05/2021 AU

(51): Classification:15-99

(54) Article to which design is applied: CUTTING TOOL HANDLING ASSEMBLY

(73) Owner: CHESTER BROWN INDUSTRIES PTY LTD 4 Stockton Rd., Port Kennedy WA 6172, Australia

(74) Agent/ Address for service: GALLOWAY & COMPANY, P. O. Box A761, Avondale, Harare, Zimbabwe



(11) Registration No.: 1292
(45) Registration date: 16/09/2022
(21) Application No.: 2021/1585
(22) Filing date: 02/11/2021
(30) Priority: 202112653 06/05/2021 AU
(51): Classification:15-99
(54) Article to which design is applied: CUTTING TOOL HANDLING ASSEMBLY
(73) Owner: CHESTER BROWN INDUSTRIES PTY LTD, 4 Stockton Rd., Port Kennedy WA 6172, Australia
(74) Agent/ Address for service: GALLOWAY & COMPANY, P. O. Box A761, Avondale, Harare, Zimbabwe



(11) Registration No.: 1343
(45) Registration date: 25/01/2023
(21) Application No.: 2021/1586
(22) Filing date: 03/11/2021
(30) Priority: 30-2021- 0049109 18/10/2021 KR
(51): Classification:23-01
(54) Article to which design is applied: CERAMIC FILTER FOR WATER PURIFIER
(73) Owner: TAB CO., LTD., 118, Jungang-ro, Jung-gu, Daejeon, Republic of Korea
(74) Agent/ Address for service: ADAMS AND ADAMS MOZAMBIQUE, Rua Estevão Ata-de, #20, R/C Bairro da Sommerschild, Maputo, Mozambique



(11) Registration No.: 1295
(45) Registration date: 19/09/2022
(21) Application No.: 2021/1592
(22) Filing date: 30/11/2021

(30)Priority: A2021/00800 09/07/2021 ZA

(51): Classification:08-03

(54) Article to which design is applied: KNIFE BLADES

(73) Owner: VECTO TRADE 461 PROPRIETARY LIMITED Lasher Building, 3 Sigma Road, Industries West, 1401 Germiston, South Africa

(74) Agent/ Address for service: ADAMS AND ADAMS MOZAMBIQUE, Rua Estevão Ata-de, #20, R/C Bairro da Sommerschild, Maputo, Mozambique

The features for which novelty is claimed are the shape and/or the configuration and/or the ornamentation of a knife blade

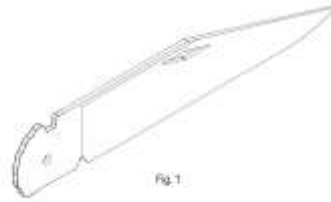

(11) Registration No.: 1296

(45) Registration date: 19/09/2022

(21) Application No.: 2021/1593

(22) Filing date: 30/11/2021

(30)Priority:

(51): Classification:

(54) Article to which design is applied: KNIFE BLADES

(73) Owner: VECTO TRADE 461 PROPRIETARY LIMITED Lasher Building, 3 Sigma Road, Industries West, 1401 Germiston, South Africa

(74) Agent/ Address for service: ADAMS AND ADAMS MOZAMBIQUE, Rua Estevão Ata-de, #20, R/C Bairro da Sommerschild, Maputo, Mozambique

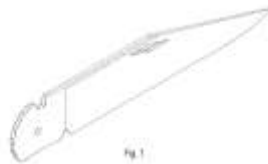

(11) Registration No.: 1278

(45) Registration date: 16/08/2022

(21) Application No.: 2021/1595

(22) Filing date: 03/12/2021

(30)Priority:

(51): Classification:06-03

(54) Article to which design is applied: WORKSTATION

(73) Owner: KOK Barend ChristiaanTROXLER Carrie Anne Yvonne 14A Bristol Road, Saxonwold, 2196, South Africa and 15A Henry Road, Rivonia, 2128, South Africa

(74) Agent/ Address for service: SAMURIWO ATTORNEYS, 2nd Floor, Block 6, Celestial Office Park, Borrowdale, Harare, Zimbabwe



(11) Registration No.: 1274
(45) Registration date: 30/06/2022
(21) Application No.: 2021/1596
(22) Filing date: 09/12/2021
(30) Priority: A2021/00820 14/07/2021 ZA
(51): Classification: 29-02
(54) Article to which design is applied: RESPIRATORY MASKS
(73) Owner: RED VILLAGE TRADING PROPRIETARY LIMITED 6 Perfecta Road, Paarden Eiland, Cape Town 7451, South Africa
(74) Agent/ Address for service: ADAMS AND ADAMS MOZAMBIQUE, Rua Estevão Ata-de, #20, R/C Bairro da Sommerschild, Maputo, Mozambique

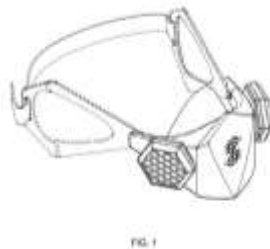

(11) Registration No.: 1280
(45) Registration date: 15/08/2022
(21) Application No.: 2021/1602
(22) Filing date: 21/12/2021
(30) Priority: 202130677003X 15/10/2021 CN
(51): Classification:
(54) Article to which design is applied: MOBILE PHONE
(73) Owner: SHENZHEN TRANSSION HOLDINGS CO., LTD., Room 1702-1703, Desay Building, No. 9789 Shennan Road, Nanshan District, Shenzhen, Guangdong 518057, China
(74) Agent/ Address for service: ROLAND INTELLECTUAL PROPERTY CONSULTANTS, 3 Maritz Street, Windhoek, P. O. Box 91198, Windhoek, Namibia



(11) Registration No.: 1315
 (45) Registration date: 13/10/2022
 (21) Application No.: 2021/1606
 (22) Filing date: 28/12/2021
 (30) Priority: 202130609179.1 14/09/2021 CN
 (51): Classification:
 (54) Article to which design is applied: EARPHONE
 (73) Owner: SHENZHEN TRANSSION COMMUNICATION LIMITED, Rooms 01-07, 14/F, Unit B Building No. 9, Shenzhen Bay Eco-Technology Park, Yuehai Street, Nanshan District, Shenzhen City, China
 (74) Agent/ Address for service: INVENTA MOZAMBIQUE, LDA., Av. 25 de Setembro, 1821 Maputo, Mozambique
 The feature for which novelty is claimed is the shape of an earphone as shown in the representations.



Front Elevation View

.....

(11) Registration No.: 1345
 (45) Registration date: 25/01/2023
 (21) Application No.: 2022/1673
 (22) Filing date: 18/05/2022
 (30) Priority: A2022/00507 12/05/2022 ZA
 (51): Classification:25-01
 (54) Article to which design is applied: BUILDING UNITS AND CONSTRUCTION ELEMENTS
 (73) Owner: VAN DAM Rodney Cornel 63 York Street, Kensington South, Johannesburg, South Africa
 (74) Agent/ Address for service: ADAMS AND ADAMS MOZAMBIQUE, Rua Estevão Ata-de, #20, R/C Bairro da Sommerschild, Maputo, Mozambique
 The features of the design for which protection is claimed include one or more of the pattern, the shape, the configuration and the ornamentation of a channel substantially as shown in the representations

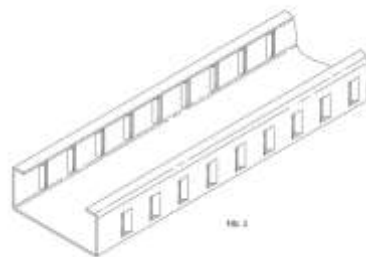

FIG. 1

.....

(11) Registration No.: 1346
 (45) Registration date: 03/01/2023
 (21) Application No.: 2022/1686
 (22) Filing date: 15/06/2022
 (30) Priority: 2021-028040 21/12/2021 JP
 (51): Classification:23-06
 (54) Article to which design is applied: TOILET PAN
 (73) Owner: LIXIL CORPORATION 2-1-1 Ojima, Koto-ku, Tokyo 136-8535, Japan
 (74) Agent/ Address for service: FISHER CORMACK & BOTHA, P. O. Box 74, Blantyre, Malawi
 The novelty of the design resides in the features of the shape and/or configuration and/or pattern and/or ornamentation of a toilet pan, but the features shown in broken lines are for illustrative purposes only, do not form part of the design and are disclaimed

FIG. 1



Perspective view

.....

10.0 Renewed Industrial Designs

10.1 National Designs

(11) Design Number:764
 (22) Filing Date: 20/03/2013
 (51) International Class. (Loc (6)):09-01
 (54) Title: BOTTLE
 (73) Owner(s): TURNED TREASURES, P.O. BOX 6208-00200, NAIROBI, Kenya
 (24) Registration extended up to: 20/03/2028

.....

(11) Design Number:1513
 (22) Filing Date: 03/02/2017
 (51) International Class. (Loc (6)):09-01
 (54) Title: BOTTLE

(73) Owner(s): NERO COMPANY LIMITED, P. O. BOX 2675-00621 NAIROBI, Kenya
 (24) Registration extended up to: 03/02/2027

.....

(11) Design Number:1093
 (22) Filing Date: 19/06/2018
 (51) International Class. (Loc (6)):09-01
 (54) Title: BOTTLE
 (73) Owner(s): KENYA WINE AGENCIES LIMITED, P.O. BOX 40550-00100 NAIROBI, Kenya
 (24) Registration extended up to: 19/06/2028

.....

11.0 Trade Marks

11.1 Applications accepted for registration

NOTICE is given that any person who has grounds of opposition to the Registration of any of the trade marks advertised herein according to these classes may within sixty (60) days from the date of this Journal, lodge a notice of opposition on form TM. No. 6 (in duplicate) together with a fee of Ksh.5,000/= (local opponent) or US\$ 250 (foreign opponent). The period of lodging the notice of opposition may be extended by the Registrar as he deems fit and upon such terms as he may direct. Any request for such extension should be made to the Registrar to reach him before the expiry of the period allowed.

Formal opposition should not be lodged until after a reasonable notice has been given in writing to the applicant for registration to afford him any opportunity of withdrawing his application before the expense of preparing the notice of opposition is incurred. Failure to give such notice will be taken into account in considering any application by an opponent for an order for costs if the opposition is uncontested by the applicant.

Representations of the marks advertised herein can be seen at the Trade Marks Registry, Kenya Industrial Property Institute, KIPI Centre, Kabarsiran Avenue Off Waiyaki Way, Lavington, Nairobi.

(210): 63880 **(220):** 15/08/2008

(300): None **(511):** 3(Cosmetics, including cosmetic preparations for slimming purposes; sun-tanning lotions for cosmetic purposes; creams for cosmetic purposes; essential oils, shampoos and hair lotions.) and 5(Pharmaceutical preparations and dietetic substances for medical use.) **(526):** Registration of this mark shall give no right to the exclusive use of the word 'HERBALS' separately and apart from the mark as a whole. **(730):** HIMALAYA HOUSE of Himalaya House, 138 Elgin Avenue, P.O. Box 1162, Grand Cayman KY1-1102, Cayman Islands **(740):** Kaplan & Stratton Advocates of P.O. Box 40111 - 00100, Nairobi, Kenya



(210): 63882 **(220):** 15/08/2008

(300): None **(511):** 3(Cosmetics, including cosmetic preparations for slimming purposes; sun-tanning lotions for cosmetic purposes; creams for cosmetic purposes; essential oils, shampoos and hair lotions.), 5(Pharmaceutical preparations and dietetic substances for medical use.) and 30(Honey and Tea formulations, and flour and preparation made from bread and confectionary.) **(526):** Registration of this mark shall give no right to the exclusive use of the word 'HERBAL' and 'HEALTHCARE' each separately and apart from the mark as a whole **(730):** HIMALAYA HOUSE of Himalaya House, 138 Elgin Avenue, P.O. Box 1162, Grand Cayman KY1-1102, Cayman Islands **(740):** Kaplan & Stratton Advocates of P.O. Box 40111 - 00100, Nairobi, Kenya



(210): 73276 **(220):** 23/11/2011

(300): None **(511):** 5(Soil conditioner) **(526):** None **(730):** ORION EAST AFRICA LIMITED of P.O. Box 10170 - 00100, Nairobi, Kenya **(740):** Mbugua Ng'ang'a & Co Advocates of P.O. Box 9316 - 00200, Nairobi, Kenya

Agri-Soc

(210): 85505 **(220):** 27/11/2014

(300): None **(511):** 18(Leather and imitations of leather, and goods made of these materials and not included in other classes; animal skins, hides; trunks and travelling bags; umbrellas and parasols; walking sticks; whips, harness and saddlery.) **(526):** None **(730):** LEVI STRAUSS & CO. of Levi's Plaza, 1155 Battery Street, San Francisco, California 94111, United States of America **(740):** J. K. Muchae & Company Advocates of P.O. Box 60664 - 00200, Nairobi, Kenya



(210): 101452 **(220):** 22/03/2018

(300): None **(511):** 1(Agrochemical.) and 5(Insecticide.) **(526):** None **(730):** ASCENDIS BIOSCIENCES EAST AFRICA LIMITED of P.O. Box 3485 - 00506 Nairobi, Kenya **(740):** None

PLEDGE

(210): 101453 **(220):** 22/03/2018

(300): None **(511):** 1(Agrochemical.) and 5(Fungicide.) **(526):** None **(730):** ASCENDIS BIOSCIENCES EAST AFRICA LIMITED of P.O. Box 3485 - 00506 Nairobi, Kenya **(740):** None

WALKER

(210): 101454 **(220):** 22/03/2018

(300): None **(511):** 1(Agrochemical.) and 5(Fungicide.) **(526):** None **(730):** ASCENDIS BIOSCIENCES EAST AFRICA LIMITED of P.O. Box 3485 - 00506, Nairobi, Kenya **(740):** None

LATITUDE

(210): 103201 **(220):** 23/07/2018

(300): None **(511):** 9(Scientific, nautical, surveying, photographic, cinematographic, optical, weighing, measuring, signalling, checking (supervision), life-saving and teaching apparatus and instruments; apparatus and instruments for conducting, switching, transforming, accumulating, regulating or controlling electricity; apparatus for recording, transmission or reproduction of sound or images; magnetic data carriers, recording discs; compact discs, DVDs and other digital recording media; mechanisms for coin-operated apparatus; cash registers, calculating machines, data processing equipment, computers; computer software; fire-extinguishing

AFRICANACITY

apparatus), 16(Paper, cardboard and goods made from these materials, not included in other classes; printed matter; bookbinding material; photographs; stationery; adhesives for stationery or household purposes; artists' materials; paint brushes; typewriters and office requisites (except furniture); instructional and teaching material (except apparatus); plastic materials for packaging (not included in other classes); printers' type; printing blocks), 35(Advertising; business management; business administration; office functions; offering for sale and the sale of goods in the retail and wholesale trade), 36(Insurance; financial affairs; monetary affairs; real estate affairs.), 38(Telecommunications), 41(education; providing of training; entertainment; sporting and cultural activities) and 42(Scientific and technological services and research and design relating thereto; industrial analysis and research services; design and development of computer hardware and software) **(526)**: None **(730)**: ABSA BANK LIMITED, a South African company of 7th Floor Absa Towers West 15 Troye Street Johannesburg Republic of South Africa **(740)**: Coulson Harney Advocates of P.O. Box 10643 - 00100, Nairobi, Kenya

(210): 109574 **(220)**: 15/10/2019

(300): None **(511)**: 16(Paper and cardboard; printed matter; bookbinding material; photographs; stationery and office requisites, except furniture; adhesives for stationery or household purposes; drawing materials and materials for artists; paintbrushes; instructional and teaching materials; plastic sheets, films and bags for wrapping and packaging; printers' type, printing blocks.) **(526)**: Registration of this mark shall give no right to the exclusive use of the word "ALUMINIUM FOIL" separately and apart from the mark as a whole. **(730)**: FRED KIAMA MWANGI of P.O. Box 4089 - 00100, Thika, Kenya **(740)**: Mungai Kuria & Muthoga LLP of P. O. Box 3118 - 00100, Nairobi, Kenya

**DANEEL ALUMINIUM
FOIL**

(210): 109574 **(220)**: 15/10/2019

(300): None **(511)**: 16(Paper and cardboard; printed matter; bookbinding material; photographs; stationery and office requisites, except furniture; adhesives for stationery or household purposes; drawing materials and materials for artists; paintbrushes; instructional and teaching materials; plastic sheets, films and bags for wrapping and packaging; printers' type, printing blocks.) **(526)**: Registration of this mark shall give no right to the exclusive use of the word "ALUMINIUM FOIL" separately and apart from the mark as a whole. **(730)**: FRED KIAMA MWANGI of P.O. Box 4089 - 00100, Thika, Kenya **(740)**: Mungai Kuria & Muthoga LLP of P. O. Box 3118 - 00100, Nairobi, Kenya

**DANEEL ALUMINIUM
FOIL**

(210): 110068 **(220)**: 19/11/2019

(300): None **(511)**: 3(Soaps, Liquid soap, hygiene products, Cleaning products.) **(526)**: None **(730)**: INTERNATIONAL FOODSTUFFS CO. LLC. of Al-Wahda Street, Industrial Area No.1 P.O. Box 4115 Sharjah, United Arab Emirates **(740)**: Talal Abu-Ghazaleh Intellectual Property of P.O. Box 2537 - 00606, Nairobi, Kenya

SAVANNAH

(210): 111084 **(220)**: 14/02/2020

(300): None **(511)**: 1(Agrochemical.) and 5(Insecticide.) **(526)**: None **(730)**: ASCENDIS BIOSCIENCES EAST AFRICA LIMITED of P.O. Box 3485 - 00506, Nairobi, Kenya **(740)**: None

STILLETTO

(210): 112100 (220): 22/05/2020

(300): None (511): 35(Shopping centre; green grocer; advertising including online e-commerce business.), 37(Installation services for vehicle service stations (refueling and maintenance) and 43(Restaurant services for providing food and drink.) (526): Registration of this mark shall give no right to the exclusive use of the words 'Shop', 'Save', 'Safi' and the device of a 'shopping cart' each separately and apart from the mark as a whole (730): SNAPFRESH INVESTMENTS LIMITED of One Africa Place, 15th floor Waiyaki way, P.O. Box 12342 - 00100, Nairobi, Kenya (740): Ensafrica (NBMA Advocates LLP) of P.O. Box 12342 - 00100, Nairobi, Kenya



(210): 112597 (220): 29/06/2020

(300): None (511): (526): Registration of this mark shall give no right to the exclusive use of the word 'NUTRI' separately and apart from the mark as a whole. (730): SOCIETE DES PRODUITS NESTLE S.A. a Swiss company of 1800 Vevey, Switzerland (740): Coulson Harney Advocates of P.O. Box 10643 - 00100, Nairobi, Kenya

NUTRILEARN

(210): 113843 (220): 15/09/2020

(300): None (511): 30(Bread and products made from wheat or baked products and from cereals.) (526): Registration of this mark shall give no right to the exclusive use of the word 'Choice', the letters "T", "N", "L", "C", "O" and the device of a "plant" each separately and apart from the mark as a whole. (730): THREE NETWORK LIMITED of P.O. Box 51112 - 00200, Nairobi, Kenya (740): None



(210): 115506 (220): 15/01/2021

(300): None (511): 29(Meat; fish (not live); poultry; game (not live); meat extracts; charcuterie; meat substitutes; frozen vegetables; preserved vegetables; vegetables, dried; vegetables, cooked; fruit, preserved; dried fruit; cooked fruits; processed fruits, fungi and vegetables (including nuts and pulses); processed vegetables; processed legumes; lentils; processed chickpeas; processed beans; baked beans; beans in sauce; soya beans, preserved, for food; tofu; tomato puree; vegetable puree; tomato juice for cooking; tinned tomatoes; vegetable juices for cooking; pickles; preparations for making soup; soups; stocks; preparations for making bouillon; bouillon; coconut milk; coconut oil; coconut fat; vegetable fats for food; dips; nuts, prepared; nut-based spreads; seeds, prepared; fruit-based snack food; snack foods based on legumes; snack foods based on nuts; snack foods based on vegetables; pre-cooked curry stew; vegetarian chili; chili con carne; prepared dishes consisting principally of meat; prepared salads; prepared vegetable dishes; prepared meals consisting primarily of meat; prepared meals consisting primarily of poultry; prepared meals consisting primarily of vegetables; prepared meals consisting primarily of fish; frozen meals consisting primarily of vegetables; frozen meals consisting primarily of meat; frozen meals consisting primarily of meat substitutes; frozen meals primarily of fish; frozen meals consisting primarily of poultry; ready cooked meals consisting primarily of meat; ready cooked meals consisting primarily of meat substitutes; ready cooked meals consisting primarily of poultry; ready cooked meals consisting primarily of vegetables; ready cooked meals consisting primarily of fish.) and 30(Rice; tapioca; sago; pasta; noodles; dumplings; vermicelli; couscous [semolina]; preparations made from cereals; processed grains; processed cereals; whole grain rice; long grain rice; wild rice; brown rice; basmati rice; parboiled rice; risotto; rice mixes; rice mixes with vegetables, chicken extracts, meat extracts, cheese, beans, legumes, spices, flavorings, herbs, seasonings; packaged meal mixes consisting primarily of rice; processed quinoa; pizzas; pies; condiments; sauces; cooking sauces; preparations for

BEN'S ORIGINAL

making up into sauces; curry sauces; pasta sauces; pasta bake sauces; chili sauce; soy sauce; hot sauce; sweet and sour sauce; spicy sauces; savoury sauces; sauces for rice; sauce powders; mixes for preparing sauces; flavourings in the form of concentrated sauces; prepared foodstuffs in the form of sauces; marinades; salad dressings; chutneys; pastes (Farinaceous food -); relishes; gravy; thickeners for cooking foodstuffs; pesto [sauce]; mustard; vinegar; salt; spices; seasonings; culinary herbs; processed garlic for use as seasoning; processed ginger for use as seasoning; minced ginger; seasoning pastes; pepper; chili seasoning; chili paste for use as a seasoning; aromatic preparations for food; flavourings for foods; extracts used as flavouring [not essential oils]; spice mixes; spice preparations; spice extracts; spice rubs; curry mixes; pasta-based prepared meals; rice-based prepared meals; noodle-based prepared meals; instant noodles; instant rice; snack food (Cereal-based -); snack food (Rice-based-); snack foods consisting principally of pasta; snack foods consisting principally of rice; meals consisting primarily of pasta; meals consisting primarily of rice; meals consisting primarily of processed grains; meals consisting primarily of processed cereals; meals consisting primarily of quinoa and processed cereals; meals consisting primarily of noodles; frozen meals consisting primarily of pasta; frozen meals consisting primarily of rice; frozen meals consisting primarily of processed grains; frozen meals consisting primarily of processed cereals; frozen meals consisting primarily of quinoa and processed cereals; frozen meals consisting primarily of noodles; dry and liquid ready-to-serve meals, mainly consisting of rice; dry and liquid ready-to-serve meals, mainly consisting of pasta; dry and liquid ready-to-serve meals, mainly consisting of noodles; processed grains combined in unitary packages with seasonings and flavourings; processed cereals combined in unitary packages with seasonings and flavourings; processed quinoa and cereals combined in unitary packages with seasonings and flavourings; rice combined in unitary packages with seasonings and flavourings; processed grains combined in unitary packages with edible seeds, pulses, legumes, or vegetables; processed cereals combined in unitary packages with edible seeds, pulses, legumes, or vegetables; processed quinoa and cereals combined in unitary packages with edible seeds, pulses, legumes, or vegetables; rice combined in unitary packages with edible seeds, pulses, legumes, or vegetables ; pasta combined in unitary packages with edible seeds, pulses, legumes, or vegetables ; noodles combined in unitary packages with edible seeds, pulses, legumes, or vegetables.) (526): Registration of this mark shall give no right to the exclusive use of the word 'Original' separately and apart from the mark as a whole. (730): MARS, INCORPORATED, a corporation organized and existing under the laws of the State of Delaware of 6885 Elm Street, McLean, VA 22101, United States of America (740): Kaplan & Stratton Advocates of P.O. Box 40111 - 00100, Nairobi, Kenya

(210): 115567 (220): 19/01/2021

(300): None (511): 30(Chocolates, Biscuits(all types), cakes, Pasta, Macaroni, Noodles, Instant Noodles, Spaghetti, Vermicelli, Yeast, Baking Powder and other Bakery Ingredients, Salad Dressings, Mayonnaise, Vinegar, Ketch Up and Sauces(condiments), ready to cook dough products, frozen dough, frozen parathas, ice creams, non-dairy frozen desserts, frozen fruit desserts, ice desserts, coffee, tea, cocoa, sugar, rice, tapioca, sago, artificial coffee, bread, pastry, treacle, salt, mustard, flour made from cereals, spices., Food beverages (Grain-based and Herbal), Gravies, Herbal tea, Honey, Popcorn.) (526): The Arabic characters are a transliteration

TIFFANY CHEEZO

تيفاني شيزو

of English words "TIFFANY CHEEZO". **(730)**: INTERNATIONAL FOODSTUFFS CO. LLC. of Al-Wahda Street, Industrial Area No.1 P.O. Box 4115 Sharjah, United Arab Emirates **(740)**: Talal Abu-Ghazaleh Intellectual Property of P.O. Box 2537 - 00606, Nairobi, Kenya

(210): 116007 **(220)**: 12/02/2021

(300): None **(511)**: 30(Coffee, tea, coca and artificial coffee; rice; tapioca and sago; flour and preparations made from cereals; bread, pastry and confectionery; ice;sugar, honey, tracle; yeast, baking-powder; salt; mustard; vinegar, sauces (condiments); spices; ice) and 31(Feeds, Animal feeds) **(526)**: Registration of this mark shall give no right to the exclusive use of the word 'SHIBISHO' and 'wheat ear' device separately and apart from the mark as a whole. The translation into English of the word 'SHIBISHO' is 'feeds that satisfy' **(730)**: LUCHU HOLDINGS LIMITED of P.O. Box 538 - 00621, Village Market, Nairobi, Kenya **(740)**: None

 The logo for SHIBISHO features the word "SHIBISHO" in a bold, green, sans-serif font. The letter "I" is replaced by a stylized yellow and orange flame or wheat ear icon.

(210): 116007 **(220)**: 12/02/2021

(300): None **(511)**: 30(Coffee, tea, coca and artificial coffee; rice; tapioca and sago; flour and preparations made from cereals; bread, pastry and confectionery; ice; sugar, honey, tracle; yeast, baking-powder; salt; mustard; vinegar, sauces (condiments); spices; ice) and 31(Feeds, Animal feeds) **(526)**: Registration of this mark shall give no right to the exclusive use of the word 'SHIBISHO' and 'wheat ear' device separately and apart from the mark as a whole. The translation into English of the word 'SHIBISHO' is 'feeds that satisfy' **(730)**: LUCHU HOLDINGS LIMITED of P.O. Box 538 - 00621, Village Market, Nairobi, Kenya **(740)**: None

 The logo for SHIBISHO features the word "SHIBISHO" in a bold, green, sans-serif font. The letter "I" is replaced by a stylized yellow and orange flame or wheat ear icon.

(210): 116180 **(220)**: 24/02/2021

(300): None **(511)**: 9(Scientific, apparatus and instruments for conducting, switching, transforming, accumulating, regulating or controlling electricity) and 11(Apparatus for lighting, heating, steam generating, cooking, refrigerating, drying, ventilating, water supply and sanitary purposes) **(526)**: Registration of this mark shall give no right to the exclusive use of the words "World", "Africa", "Impactful", "Sustainable", "Scalable", "Light" and the device of "Map of Africa" separately and apart from the mark as a whole. **(730)**: WORLD LIGHT AFRICA of +254722890060 - 00100, Nairobi, Kenya **(740)**: Agan & Associates of P.O. Box 52564 - 00200, Nairobi, Kenya

 The logo for WorldLight Africa features a stylized map of Africa in blue and yellow, with the text "WorldLight Africa" in blue and "Impactful, Sustainable & Scalable" in smaller blue text below it.

(210): 116723 **(220)**: 09/04/2021

(300): None **(511)**: 35(Wholesale, retail or e-commerce, online sale of Pharmaceutical, Medicinal, Surgical, Healthcare, Cosmetics, and consumer care products including Sanitizers; Soaps; Hand Wash, Shampoo; Baby Oil, Body Oil; Moisturizers; Talcum Powder; Dentifrices, Toothbrushes, Mouthwashes.) **(526)**: None **(730)**: ZIP LIMITED, A company incorporated under the Isle of Man Companies Act, 2006 of Commerce House, 1 Bowring Road, Ramsey, Isle of Man IM8 2LQ, Isle of Man **(740)**: Simba & Simba & Co. Advocates of P.O. Box 10312 - 00100, Nairobi, Kenya

 The logo for zip features the word "zip" in a bold, green, lowercase, sans-serif font on a dark green background.

(210): 116903 **(220)**: 20/04/2021

(300): None **(511)**: 33(Beverages carbonated with alcohol; alcoholic beverages except wines) **(526)**: Registration of this mark shall give no right to the exclusive use of the word "LEMON" separately and apart from the mark as a whole. **(730)**: THE COCA-COLA COMPANY of One Coca-Cola Plaza, Atlanta GA 30313, United States of America **(740)**: Iseme, Kamau & Maema Advocates of P.O. Box 11866 - 00400, Nairobi, Kenya

LEMON-DOU

(210): 117215 **(220):** 07/05/2021
(300): None **(511):** 39(Transport; packaging and storage of goods; transport arrangement) **(526):** Registration of this mark shall give no right to the exclusive use of the words 'CARGO', 'LTD.', 'LOG', 'FREIGHT', 'CUSTOMISED' and 'SOLUTIONS' each separately and apart from the mark as a whole. **(730):** CARGO FREIGHT LIMITED of P.O. Box 62687 - 00200, Pili Trade Godown 1 Mombasa Road, Nairobi, Kenya **(740):** None



(210): 117308 **(220):** 13/05/2021
(300): None **(511):** 9(Solar panels for the production of electricity, solar batteries.) **(526):** Registration of this mark shall give no right to the exclusive use of the word "SOLAR" separately and apart from the mark as a whole. **(730):** MABATI ROLLING MILLS LIMITED of P.O. Box 271-00204, Athi River, Kenya **(740):** None

SAFSOLAR

(210): 117543 **(220):** 28/05/2021
(300): None **(511):** 5(Pharmaceutical and veterinary preparations; sanitary preparations for medical purposes; dietetic food and substances adapted for medical or veterinary use, food for babies; dietary supplements for humans and animals; plasters, materials for dressings; material for stopping teeth, dental wax; disinfectants; preparations for destroying vermin; fungicides, herbicides) **(526):** Registration of this mark shall give no right to the exclusive use of the word 'BONE', "HEALTH" and 'Bone' device each separately and apart from the mark as a whole. **(730):** KINETIC RESOURCES LIMITED of P.O. Box 5186 - 00200, Nairobi, Kenya **(740):** None



(210): 117993 **(220):** 25/06/2021
(300): None **(511):** 30(Chocolates, biscuits(all types), cakes, pasta, macaroni, noodles, instant noodles, spaghetti, vermicelli, yeast, baking powder and other bakery ingredients, salad dressings s, mayonnaise, vinegar, ketch u and sauces(condiments), ready to cook dough products, frozen dough, frozen parathas, ice creams, non-dairy frozen desserts, frozen fruit desserts, ice desserts, coffee, tea, cocoa, sugar, rice, tapioca, sago, artificial coffee, bread, pastry, treacle, salt, mustard, flour made from cereals, spices, food beverages (Grain-based and Herbal), gravies, herbal tea, honey, popcorn.) **(526):** The Arabic characters are a transliteration of TIFFANY GOAL. **(730):** INTERNATIONAL FOODSTUFFS CO. LLC. of Al-Wahda Street, Industrial Area No. 1, P.O. Box 4115, Sharjah, United Arab Emirates **(740):** Talal Abu-Ghazaleh Intellectual Property of P.O. Box 2537 - 00606, Nairobi, Kenya

TIFFANY GOAL
 تيفاني غول

(210): 118301 **(220):** 16/07/2021
(300): None **(511):** 16(Paper and cardboard; printed matter; bookbinding material; photographs; stationery; adhesives for stationery or household purposes; artists' materials; paintbrushes; typewriters and office requisites (except furniture); instructional and teaching material (except apparatus); plastic materials for packaging; printers' type; printing blocks.), 41(Education; providing of training; entertainment; sporting and cultural activities.) and 45(conducting religious ceremonies; organization of religious meetings) **(526):** Registration of this mark shall give no right to the exclusive use of the words "CHRIST", "MINISTRIES" and the device of a "Dove" and the "cross" each separately and apart from the mark as a whole. **(730):** CHRIST IS THE ANSWER MINISTRIES (CITAM) of P.O. Box 42254 - 00100, Nairobi, Kenya **(740):** Simba & Simba Advocates of P. O. Box 10312 - 00100, Nairobi, Kenya



(210): 118960 (220): 31/08/2021

(300): None (511): 7(Motor operated and electric coffee grinders and apparatus; electric coffee mills), 11(Electric coffee machines; electric coffee percolators; coffee roasters), 16(Paper coffee filters), 21(Non-electric coffee filters; hand operated coffee grinders; non-electric coffee percolators; coffee services (tableware); non-electric coffee pots), 30(Coffee and coffee-derived and based drinks and beverages; roasted and unroasted coffee; iced coffee; artificial coffee; chicory (coffee substitute); coffee flavourings; coffee beverages with milk; vegetal preparations for use as coffee substitutes; tea and tea- derived and based drinks and beverages; iced tea; tea beverages with milk; cocoa and cocoa derived and based drinks; chocolate chocolate-derived and chocolate-based drinks; edible ices; bread, pastries and confectionery), 32(Mineral and aerated drinks and beverages; non-alcoholic drinks and beverages; non-alcoholic beverages flavoured with coffee; non-alcoholic beverages flavoured with tea; fruit beverages and fruit juices; syrups and other preparations for making beverages) and 43(Services for providing food and drink for purposes of consumption) **(526): Registration of this mark shall give no right to the exclusive use of the word "CAFFE", the acronym "TOMOCA", the letter "K" and the device of "coffee beans" each separately and apart from the mark as a whole. "TOMOCA" is an acronym of the Italian phrase "Torrefazione Moderna Cafe" which translates to the phrase "Modern Coffee Roasting". The character included in the mark is an Amharic language which in English translates to the word "Coffee". **(730):** TOMOCA COFFEE KENYA LIMITED of P.O. Box 71141 - 00610, Two Rivers Mall, Ground Floor, Limuru Road, Nairobi, Kenya **(740):** Garane & Somane Advocates of P.O. Box 20617 - 00100, Nairobi, Kenya**



(210): 118961 (220): 31/08/2021

(300): None (511): 7(Motor operated and electric coffee grinders and apparatus; electric coffee), 11(Electric coffee machines; electric coffee percolators; coffee roasters), 16(Paper coffee filters), 21(Non-electric coffee filters; hand operated coffee grinders; non-electric coffee percolators; coffee services (tableware); non-electric coffee pots), 30(Non-electric coffee filters; hand operated coffee grinders; non-electric coffee percolators; coffee services (tableware); non-electric coffee pots), 32(Mineral and aerated drinks and beverages; non-alcoholic drinks and beverages; non-alcoholic beverages flavoured with coffee; non-alcoholic beverages flavoured with tea; fruit beverages and fruit juices; syrups and other preparations for making beverages) and 43(Services for providing food and drink for purposes of consumption) **(526): Registration of this mark shall give no right to the exclusive use of the word "CAFFE", the acronym "TOMOCA", the letter "K", phrase "Since 1953" and the device of "coffee beans" each separately and apart from the mark as a whole. "TOMOCA" is an acronym of the Italian phrase "Torrefazione Moderna Cafe" which translates to the phrase "Modern Coffee Roasting". The character included in the mark is an Amharic language which in English translates to the word "Coffee". **(730):** TOMOCA COFFEE KENYA LIMITED of P.O. Box 71141 - 00610, Two Rivers Mall, Ground Floor, Limuru Road, Nairobi, Kenya **(740):** Garane & Somane Advocates of P.O. Box 20617 - 00100, Nairobi, Kenya**



(210): 119367 **(220):** 24/09/2021**(300):** None **(511):** 44(Medical services; veterinary services; hygienic and beauty care for human being or animals; agriculture, aquaculture, horticulture and forestry services) **(526):** Registration of this mark shall give no right to the exclusive use of the word the word "Diagnostics" separately and apart from the mark as a whole. **(730):** AL-BORG MEDICAL LABORATORIES of Kingdom of Saudi Arabia, Jeddah, Bani Malik Distrct, Palestine Street, P.O. Box 52817, Postal Code 21573, Saudi Arabia **(740):** Talal Abu-Ghazaleh Intellectual Property of P.O. Box 20140 - 00100, Nairobi, Kenya**(210):** 119368 **(220):** 24/09/2021**(300):** None **(511):** 44(Medical services; veterinary services; hygienic and beauty care for human beings or animals; agriculture, horticulture and forestry services) **(526):** Registration of this trademark shall give no right to the exclusive use of the words "Care" and "Programs" each separately and apart from the mark as a whole. The Arabic characters are a transliteration of Al Borg Care Programs **(730):** AL-BORG MEDICAL LABORATORIES of Kingdom of Saudi Arabia, Jeddah, Bani Malik Distrct, Palestine Street, P.O. Box 52817, Postal Code 21573, Saudi Arabia **(740):** Talal Abu-Ghazaleh Intellectual Property of P.O. Box 20140 - 00100, Nairobi, Kenya**(210):** 119369 **(220):** 24/09/2021**(300):** None **(511):** 44(Medical services; veterinary services; hygienic and beauty care for human beings or animals; agriculture, horticulture and forestry services) **(526):** Registration of this trademark shall give no right to the exclusive use of the letters "D" and "X" each separately and apart from the mark as a whole. **(730):** AL-BORG MEDICAL LABORATORIES of Kingdom of Saudi Arabia, Jeddah, Bani Malik Distrct, Palestine Street, P.O. Box 52817, Postal Code 21573, Saudi Arabia **(740):** Talal Abu-Ghazaleh Intellectual Property of P.O. Box 20140 - 00100, Nairobi, Kenya**Al Borg DX****(210):** 119573 **(220):** 07/10/2021**(300):** None **(511):** 43(Providing temporary accommodations; rental of temporary accommodation; reservations of temporary accommodations; hotel, motel, bar, cafe, restaurant, banquet and catering services; rental of rooms for holding functions, conferences, conventions, exhibitions, seminars and meetings.) **(526):** None **(730):** HILTON WORLDWIDE MANAGE LIMITED (a private company limited by shares organized under the laws of the United Kingdom) of Maple Court Central Park Reeds Crescent Watford WD24 4QQ, United Kingdom **(740):** Ensafrica of P. O. Box 12342 - 00100, Nairobi, Kenya**TAPESTRY****(210):** 119804 **(220):** 25/10/2021**(300):** None **(511):** 12(Vehicles; apparatus for locomotion by land, air or water.) and 35(Advertising; business management; business administration; office functions.) **(526):** None **(730):** MR. RISHI KOHLI of P.O. Box 257 - 0010, Kisumu, Kenya **(740):** Gichachi & Company Advocates of P.O. Box 79659 - 00200, Nairobi, Kenya**FIKA****(210):** 119861 **(220):** 28/10/2021**(300):** None **(511):** 41(Games & Entertainment) **(526):** Registration of this mark shall give no right to the exclusive use of the device of 'Paper plane' separately and apart from the mark as a whole. **(730):** GAME GUYS LIMITED of P.O. Box 34776 - 00100, Nairobi, Kenya **(740):** None**(210):** 120210 **(220):** 23/11/2021**(300):** None **(511):** 38(Communication services) **(526):** Registration of this mark shall give no right to the exclusive use of the word "POD", the numerals "4", "5" and the devices of the "MICROPHONE" and "HEADPHONE" each separately and apart from the mark as a whole. **(730):** ZWENA GROUP LIMITED of P.O. Box 38585 - 00100, Keystone Park. Block A, 3rd Floor, 95 Riverside Drive, Riverside, Nairobi, Kenya **(740):** None

(210): 120211 **(220):** 23/11/2021

(300): None **(511):** 38(Communication services) **(526):** Registration of this mark shall give no right to the exclusive use of the letter "B" and the acronym "TV" each separately and apart from the mark as a whole. **(730):** ZWENA GROUP LIMITED of Kiddy Arcade, Kiddy Arcade Building, Ground Floor, P.O. Box 38585 - 00100, Nairobi, Kenya **(740):** None



(210): 120584 **(220):** 15/12/2021

(300): None **(511):** 25(Shoes) **(526):** None **(730):** CITY WALK LIMITED of P.O. Box 294 - 00621, Nairobi, Kenya **(740):** None



(210): 120610 **(220):** 17/12/2021

(300): None **(511):** 30(Coffee, tea, cocoa and artificial coffee; rice; tapioca and sago; flour and preparations made from cereals; bread, pastry and confectionery; ices; sugar, honey, treacle; yeast, baking powder; salt; mustard; vinegar, sauces (Condiments); spices; ice.) **(526):** Registration of this mark shall give no right to the exclusive use of the words 'MWEA', 'GOLD' and devices of 'Mountain' and 'rice plant' each separately and apart from the mark as a whole. **(730):** MWEA GOLD PRODUCT OF BT AGRICULTURAL LIMITED of P.O. Box 1222 - 00502, Nairobi, Kenya **(740):** None



(210): 120748 **(220):** 23/12/2021

(300): None **(511):** 9(Computer software, recorded; downloadable software; downloadable software applications [apps]; Computer software platforms, recorded or downloadable; computer e-commerce software to allow users to perform electronic business transactions via a global computer network; application software for mobile phones; cloud computing software), 35(Online retail and wholesale services; retail and wholesale services; Advertising services, namely, dissemination of advertising for others via an on-line electronic communications network; On-line ordering services; Business intermediary services for the sale and purchase of goods and services; Auction services; Classified advertising services; Mail order sales; Computerized on-line ordering featuring general merchandise and general consumer goods; Automated and computerized trading services; On-line trading services; Product merchandising for others; Provision of information and advisory services relating to e-commerce; E-commerce services; Website hosting; Sales and auction services relating to consumer goods; import-export agency services; advisory services relating to import-export agencies.), 36(Financial services; online escrow services relating to the exchange of goods and services; holding securities, funds and other assets in escrow; e-wallet payment services; payment processing services; Electronic commerce payment services; Customs brokerage; customs brokerage agency services; issuance of customer loyalty points; issuance of customer loyalty discount cards.), 38(Providing access to computer networks; providing access to computer databases; providing access to on-line computer data bases; Providing access to e-commerce platforms on the Internet; provision and rental of access time to data banks; transmission of data via computer networks; net casting [broadcasting over a global computer network]; computer aided transmission of messages, data and images; rental of access time to computer databases; transmission of data and information by computer and electronic communication means; providing on-line chatrooms and electronic bulletin boards for transmission of messages among computer users; providing multiple user access to global computer information networks for the transfer and dissemination of a wide range of information; consultancy,



information and advisory services in the field of telecommunications.) and 42(Software as a service [SAAS]; platform as a service [PAAS]; hosting of e-commerce platforms on the Internet; programming of software for e-commerce platforms; consultancy relating to the creation and design of websites for e-commerce; consultancy services relating to software used in the field of e-commerce; maintenance of software used in the field of e-commerce; design and development of computer software for logistics, supply chain management and e-business portals; computer software design; maintenance of computer software; updating of computer software; creating and maintaining web sites for others; hosting computer sites [web sites]; cloud computing; computer programming; development of computer platforms; software engineering; provision of online non-downloadable software [application service provider]; electronic data storage; consultancy in the field of programming and development of e-business portals.)

(526): Registration of this trademark shall give no right to the exclusive use of the words "WORLD" and letters "D" and "P" each separately and apart from the mark as a whole. **(730):** DP WORLD FZE of 5th Floor, LOB 17, Jebel Ali Free Zone, Dubai, United Arab Emirates **(740):** Muthoni Advocates of P.O. Box 28397 - 00200, Nairobi, Kenya

(210): 120812 **(220):** 11/01/2022

(300): None **(511):** 30(Black tea.) **(526):** Sokot is a Nandi word which means Leaf. **(730):** EASTERN PRODUCE KENYA LIMITED of P.O. Box 45560 - 00100, Nairobi, Kenya **(740):** None



(210): 120957 **(220):** 19/01/2022

(300): None **(511):** 5(Medicinal and pharmaceutical preparations.) **(526):** None **(730):** AMINA LIMITED of P.O. Box 3175, Road Town, Tortola, Virgin Islands (British) **(740):** SIMBA & SIMBA ADVOCATES, P.O. Box 10312 - 00100, FINANCE HOUSE, 6th Floor, Loita Street, Nairobi

SHALDOGREL

(210): 120970 **(220):** 19/01/2022

(300): None **(511):** 9(Downloadable software for mobile phones, computers and wireless devices for use by healthcare providers to track vaccinations and patient vaccination information; downloadable software for mobile phones, computers and wireless devices for scheduling confirming, reminding of appointments, and conducting vaccination and ensuring accurate identification of the person to be vaccinated; Downloadable computer software and downloadable computer application software for providing vaccine education, vaccine enrollment, vaccine administration, vaccine prioritization, information on vaccines, alerts, appointments, reminders, vaccine certificates, vaccine record reporting and analysis, and post-vaccination surveillance and reporting.) and 42(Providing an online platform featuring software for providing vaccine education, vaccine enrollment, vaccine distribution, vaccine administration, vaccine prioritization, information on vaccines, alerts, appointments, reminders, vaccine certificates, vaccine record reporting and analysis, and post-vaccination surveillance and reporting.) **(526):** Registration of this mark shall give no right to the exclusive use of the letters 'V', 'X' and 'N' each separately and apart from the mark as a whole. **(730):** JOHNSON & JOHNSON a corporation organised and existing under the laws of the State of New Jersey of One Johnson & Johnson Plaza, New Brunswick, New Jersey, 08933, United States of America **(740):** Kaplan & Stratton Advocates of P.O. Box 40111 - 00100, Nairobi, Kenya

VXNAID

(210): 121015 **(220):** 24/01/2022

(300): None **(511):** 39(Air transportation of passengers, mail and cargo; tourism services; organization of excursions; travel agency services; storage of mail and cargo; surface transportation; services related to travel included in the class; providing transportation services and travel reservations services through informatics.) **(526):** None **(730):** GUARDANT, INC. of 1030 Delta Boulevard Atlanta, Georgia, United States of America **(740):** Kaplan & Stratton Advocates of P.O. Box 40111 - 00100, Nairobi, Kenya

SKYCLEARED

(210): 121119 **(220):** 31/01/2022

(300): None **(511):** 2(In Paints, varnishes, lacquers; preservatives against rust and against deterioration of wood; colorants, dyes; inks for printing, marking and engraving; raw natural resins; metals in foil and powder form for use in painting, decorating, printing and art.) and 19(In Building materials (non-metallic); non-metallic rigid pipes for building; asphalt, pitch and bitumen; nonmetallic transportable buildings; monuments, not of metal.) **(526):** Registration of this mark shall give no right to the exclusive use of the word "AQUA" separately and apart from the mark as a whole. **(730):** BASCO PRODUCTS (KENYA) LIMITED of P.O. Box 48472 - 00100, Nairobi, Kenya **(740):** Moses Osoro Advocates of P.O. Box 103658 - 00101, Nairobi, Kenya

Aqua
TECH

(210): 121376 **(220):** 17/02/2022

(300): None **(511):** 16(Newspapers), 35(Advertising and Business Management), 38(Telecommunications) and 41(Education and Entertainment) **(526):** Registration of this mark shall give no right to the exclusive use of the letter "M" and the word 'GAZETI' each separately and apart from the mark as a whole. The translation into English of the Kiswahili word "GAZETI" is "Newspaper" **(730):** CONVERGENCE AFRICA MEDIA LIMITED of P.O. Box 74497 - 00200, Lion Place, Waiyaki Way, Nairobi, Kenya **(740):** None

 **MGAZETI**

(210): 121396 **(220):** 18/02/2022

(300): None **(511):** 16(Newspapers), 35(Advertising and Business Management), 38(Telecommunications) and 41(Education and Entertainment) **(526):** Registration of this mark shall give no right to the exclusive use of the letter "M" and the word 'GAZETI' each separately and apart from the mark as a whole. The translation into English of the Kiswahili word "GAZETI" is "Newspaper" **(730):** CONVERGENCE AFRICA MEDIA LIMITED of P.O. Box 74497 - 00200, Lion Place, Waiyaki Way, Nairobi, Kenya **(740):** None

MGAZETI

(210): 121539 **(220):** 02/03/2022

(300): None **(511):** 33(Alcoholic beverages (except beer), distilled beverages, gin, vodka, whiskey, brandies and liqueurs), 39(Arranging and conducting jungle and safari expeditions, Sightseeing, tour guide and excursion services and balloon tour organization.) and 43(Hotel services and temporary accommodation; making hotel reservations for others and temporary accommodation; organization, arrangement and provision of temporary holiday accommodation and reservation of temporary accommodation; Tour operator services for the booking of temporary accommodation; Travel agencies for arranging accommodation; Providing travel lodging information services and travel lodging booking agency services for travelers; services for providing food and drink, snack bars, self-service, cafeterias, bars and catering; provision of food and drink.) **(526):** Registration of this mark shall give no right to the exclusive use of the word 'HOTEL', the letters 'M' and 'G' each separately and apart from the mark as a whole. **(730):** MGM MUTHU HOTEL LTD of Strovolou, 47 Kyros Tower, 5th Floor, Strovolos 2018, Nicosia, Cyprus **(740):** Kaplan & Stratton Advocates of P.O. Box 40111 - 00100, Nairobi, Kenya

MGM
MUTHU HOTELS

(210): 121596 **(220):** 09/03/2022

(300): None **(511):** 5(Herbicide) **(526):** Registration of this mark shall give no right to the exclusive use of the numerals "4", "8", "0", the letters "S", "L" and the device of "Leaf" per se each separately and apart from the mark as a whole. **(730):** MAX POT LTD of P.O. Box 58611 - 00200, Nairobi, Kenya **(740):** None



(210): 121754 **(220):** 21/03/2022

(300): None **(511):** 20(Chairs and tables) and 22(Tents) **(526):** Registration of this mark shall give no right to the exclusive use of the letter 'A' separately and apart from the mark as a whole. **(730):** AOLANDA LIMITED of P.O. Box 25867 - 00100, Nairobi, Kenya **(740):** None



(210): 121770 **(220):** 22/03/2022

(300): None **(511):** 9(Computer hardware; electronic components for computers; blank storage apparatus for computer data; blank sound cards; blank memory storage devices; Computer memory hardware; RAM cards; Motherboards; Power units; Power modules; Wireless computer mice; Wireless computer peripherals; Pairable wireless speakers; computer keyboards; Input devices for computers; Camera stands; Video camera stands; Charging apparatus; Battery charging equipment; USB Hardware; USB cables; USB flash drives; Devices for hands-free use of mobile phones; Screen protectors for mobile phones; Protective covers and cases for mobile phones; Headsets for use with computers; Sleeves for laptops; Handheld personal computers; Personal home computers; Computerized personal organizers; Smartphones in the shape of a watch; Batteries; Lithium batteries; Solar battery chargers; Solar batteries; Rechargeable batteries; Mobile phone stands; DVD players and recorders; Digital cameras; Compact digital cameras; USB Chargers; Power connectors; high definition multimedia interface cables; Car audio apparatus, namely, in-car compact disc players, in-car radios, in-car media players, in-car loudspeakers, in-car amplifiers, in- car navigation equipment; Camera mounts; Tablet holders adapted for use in cars; In-car telephone handset cradles; Audio cable connectors; AC chargers: Charging cables; Charging docks; External battery packs; External storage devices, namely, external computer hard drives; Audio equipment, namely, amplifiers, vinyl record players, turntables, graphic equalizers, compact disc players, digital media players, microphones; Portable media players; Headphones; Loudspeakers; Loudspeaker stands; Parts and fittings for all aforesaid goods; All of the aforementioned products for use with personal computers, tablet computers for personal use, and other personal electronic and mobile communications devices, and not for operational monitoring, regulation, and control of electric motors.) **(526):** None **(730):** DELL INC., corporation, Delaware of One Dell Way, Round Rock, Texas 78682, United States of America **(740):** Hamilton Harrison & Mathews Advocates of P.O. Box 30333 - 00100, Nairobi, Kenya

PowerFlex

(210): 121825 **(220):** 25/03/2022

(300): None **(511):** 9(Couplers [data processing equipment]; Computer software applications, downloadable; Security tokens [encryption devices]; Personal digital assistants [PDAs]; Computer software platforms, recorded or downloadable; Downloadable software applications for mobile phones.), 35(Advertising; Presentation of goods on communication media, for retail purposes; Business management assistance; Providing business information, also via internet, the cable network or other forms of data transfer; Sales promotion for others; Provision of an online marketplace for buyers and sellers of goods and services; Search engine optimisation for sales promotion; Updating and maintenance of data in computer databases.), 36(Capital investment; Financing services; Financial



consultancy; Electronic funds transfer; Providing financial information; Business liquidation services, financial; Surety services.) and 42(Software as a service [SaaS]; Server hosting; Electronic data storage; Providing information relating to computer technology and programming via a website; Cloud computing; Platform as a service [PaaS]; Design and development of databases.) (526): None (730): AMBER AI LIMITED of 2506-10 25/F Prosperity Tower, 39 Queen's Road Central, Central, HK, China (740): Simba & Simba & Co. Advocates of P.O. Box 10312 - 00100, Nairobi, Kenya

(210): 121849 (220): 29/03/2022

(300): None (511): 35(Advertising; business management, organization and administration; office functions.) and 41(Education; providing of training; entertainment; sporting and cultural activities) (526): Registration of this mark shall give no right to the exclusive use of the words "UNIVERSITY", "EXCELLENCE", "TRANSFORMATION", "SERVANT-LEADERSHIP", the year "1973" and the numerals "1", "3", "7" and "9" each separately and apart (730): DAYSTAR UNIVERSITY of P.O. Box 44400 - 00100, Nairobi, Kenya (740): CFL Advocates of P.O. Box 23555 - 00100, Nairobi, Kenya



(210): 122155 (220): 25/04/2022

(300): None (511): 30(Coffee, tea, cocoa, sugar, rice, pasta, noodles, tapioca, sago, artificial coffee; flour and preparations made from cereals, bread, pastry and confectionery, ices; honey, treacle; yeast, baking-powder; salt, mustard; vinegar, sauces (condiments); spices; Ice.), 32(Beers; mineral and aerated waters and other non-alcoholic drinks; fruit drinks and fruit juices; syrups and other preparations for making beverages.), 33(Alcoholic beverages (except beers); alcoholic preparation for making beverages) and 43(Services for providing food and drink; temporary accommodation) (526): Registration of this mark shall give no right to the exclusive use of the words "NAIROBI", "STREET" and "KITCHEN" each separately and apart from the mark as a whole. (730): NAIROBI STREET KITCHEN LIMITED of Aspire Center / L.R No. 206/10 & L.R No. 206/09, Waiyaki Way, P. O. Box 48296 - 00100, Nairobi, Kenya (740): Eunice Adoyo Otieno of P.O. Box 37030 - 00200, Nairobi, Kenya



(210): 122156 (220): 25/04/2022

(300): None (511): 29(Meat, fish, poultry and game; meat extracts; preserved, dried and cooked fruits and vegetables; jellies, jams, compotes; eggs, milk and milk products; edible oils and fats.), 30(Coffee, tea, cocoa, sugar, rice, tapioca, sago, artificial coffee; flour and preparations made from cereals, bread, pastry and confectionery, ices; honey, treacle; yeast, baking-powder; salt, mustard; vinegar, sauces (condiments); spices; ice.), 32(Beers; mineral and aerated waters and other non-alcoholic drinks; fruit drinks and fruit juices; syrups and other preparations for making beverages.), 33(Alcoholic beverages (except beers) and 36(Insurance; financial affairs; monetary affairs; real estate affairs) (526): IRegistration of this mark shall give no right to the exclusive use of the letter "I" separately and apart from the mark as a whole. (730): SIMBA CORPORATION LIMITED of P.O. Box 48296 - 00100, Nairobi, Kenya (740): Eunice Adoyo Otieno of P.O. Box 37030 - 00200, Nairobi, Kenya



(210): 122157 (220): 25/04/2022

(300): None (511): 29(Meat, fish, poultry and game; meat extracts; preserved, dried and cooked fruits and vegetables; jellies, jams, compotes; eggs, milk and milk products; edible oils and fats.), 30(Coffee, tea, cocoa, sugar, rice, tapioca, sago, artificial coffee; flour and preparations made from cereals, bread, pastry and confectionery, ices; honey, treacle; yeast, baking-powder; salt, mustard; vinegar, sauces (condiments); spices; ice.), 32(Beers; mineral and aerated waters and other non-alcoholic drinks; fruit



drinks and fruit juices; syrups and other preparations for making beverages.), 33(Alcoholic beverages (except beers) and 36(Insurance; financial affairs; monetary affairs; real estate affairs) (526): IRegistration of this mark shall give no right to the exclusive use of the letter "I" separately and apart from the mark as a whole. (730): Simba Corporation Limited of P.O. Box 48296 - 00100, Nairobi, Kenya (740): Eunice Adoyo Otieno of P.O. Box 37030 - 00200, Nairobi, Kenya

(210): 122213 (220): 28/04/2022

(300): None (511): 41(Education; Providing of training; Entertainment; and Sporting and cultural activities.) (526): Registration of this trademark shall give no right to the exclusive use of the words "EDUCATIONAL", "INTERNATIONAL", "CONSULTANTS" and the device of a "graduation cap" per se each separately and apart from the mark as a whole. (730): EDUCATIONAL PATH INTERNATIONAL CONSULTANTS LIMITED of Western Heights Building, 10th Floor, Karuna Road, P.O. Box 2417 - 00606, Nairobi, Kenya (740): O & M Law, P.O. Box 49393-00100, Nairobi



(210): 122414 (220): 13/05/2022

(300): None (511): 11(Apparatus for lighting, heating, steam generating, cooking, refrigerating, drying, ventilating, water supply and sanitary purposes.) (526): 'Fogo' is an abbreviation for 'Focused On Generators Only' (730): FOGO GENERATORS LIMITED of P. O. Box 1466 - 00100, Nairobi, Kenya (740): None



(210): 122614 (220): 27/05/2022

(300): None (511): 44(Medical services; veterinary services; hygienic and beauty care services; medical analysis services; pharmaceutical services; advice, consultation and information services pertaining to the aforementioned.) (526): Registration of this mark shall give no right to the exclusive use of the word HEALTH" separately and apart from the mark as a whole. 'Kena' is a word originating from Sesotho, a local South African language meaning to 'welcome or join' (730): KENA HEALTH (PTY) LIMITED of 4th Floor, The Bank, 24 Cradock Avenue, Rosebank, Johannesburg, 2196, Gauteng, South Africa (740): CFL Advocates of P.O. Box 23555 - 00200, Nairobi, Kenya



(210): 122634 (220): 30/05/2022

(300): None (511): 41(Education; providing of training; entertainment; sporting and cultural activities) (526): Registration of this mark shall give no right to the exclusive use of the words 'Africa', 'Distribution', 'Powered by' and 'User Care' each separately and apart from the mark as a whole. (730): KODRIS AFRICA CONSULTING LIMITED -PVT-9XUGAGQ3 of P. O. Box 69947 - 00400, Nairobi, Kenya (740): K.M. Mburu & Associates of P.O. Box 1206 - 00100, Nairobi, Kenya



(210): 122651 (220): 31/05/2022

(300): None (511): 3(Metals, building metals) (526): Registration of this mark shall give no right to the exclusive use of the device of a globe ,letters "Y" and "W" each separately and apart from the mark as a whole (730): RUI DONG MING of Maisonette 3 Off Wood Avenue, P.O. Box 9561 - 00100, Nairobi, Kenya (740): None



(210): 122688 (220): 03/06/2022

(300): None (511): 29(Processed nuts) (526): 'Sherehe' means 'Celebration' (730): ALMAAJAYS of P.O. Box 56100 - 00200, Nairobi, Kenya (740): None



ZIMERI**(210):** 122876 **(220):** 17/06/2022**(300):** None **(511):** 5(Pesticides; Insecticides; Herbicides; Fungicides; Nematicides.) **(526):** None **(730):** FMC Corporation and FMC Agricultural Solutions A/S of 2929 Walnut Street, Philadelphia, Pennsylvania 19104 and Thyboronvej 78, Harboore, Ronland, 7673 Denmark, United States of America **(740):** CFL Advocates of P.O. Box 23555 - 00100, Nairobi, Kenya**(210):** 122948 **(220):** 23/06/2022**(300):** None **(511):** 5(Veterinary preparations and substances; sanitary preparations and substances for medical purposes; pesticides; parasiticides; disinfectants and insecticides; medicated animal feedstuffs; vitamin preparations for animals; antibiotics; therapeutic medicinal products; antiparasiticides; feed supplements for animals; feed additives for animals; dietetic food and substances adapted for medical or veterinary use; all mentioned products for use on animals.) **(526):** Registration of this mark shall give no right to the exclusive use of the words "COURO", "LIMPO" and "SPRAY" **(730):** ROTAM AGROCHEM INTERNATIONAL COMPANY LIMITED of Unit 6, 26/F, Trend Centre, 29 Cheung Lee Street, Chai Wan, Hong Kong **(740):** Hamilton Harrison & Mathews Advocates of P.O. Box 30333 - 00100, Nairobi, Kenya**(210):** 122976 **(220):** 27/06/2022**(300):** None **(511):** 9(Computer hardware; Computer peripherals; blank usb flash drives; Computer software, recorded; Solid-state drives; Computer memory devices; Semiconductor memory devices; Semiconductor devices; Flash card adaptors; Integrated circuit cards [smart cards]; Computer software applications, downloadable; Computers for use in data management; Bags adapted for laptops; Cases for smartphones; Portable media players; Blank USB cards; USB flash drives; Blank flash memory cards; External computer hard drives; Computer programmes [programs], recorded; Computer programs [downloadable software]; Diagnostic apparatus, not for medical purposes; Disk drives; Data processing apparatus; Electronic memories; Chipcards; Electric apparatus for commutation; Integrated circuit chips; integrated circuits; Interfaces for computers; Semi-conductors; Batteries, electric; Battery chargers; Low-voltage power supply; Electricity conduits.) **(526):** None **(730):** WESTERN DIGITAL TECHNOLOGIES, INC. of 5601 Great Oaks Parkway, San Jose, California 95119, United States of America **(740):** Iseme, Kamau & Maema Advocates of P.O. Box 11866 - 00400, Nairobi, Kenya**(210):** 123073 **(220):** 04/07/2022**(300):** None **(511):** 9(Phones.) **(526):** Registration of this mark shall give no right to the exclusive use of the words "Phone", "Electronics", "Phone device" and letter "P" each separately and apart from the mark as a whole. **(730):** PHONE PLACE ELECTRONICS of P.O. Box 76849 - 00620, Nairobi, Kenya **(740):** None**(210):** 123108 **(220):** 07/07/2022**(300):** None **(511):** 9(Computer operating programs, computer programs, downloadable, computer programs, recorded, computer software applications, downloadable, computer software platforms, recorded or downloadable, computer software, recorded.), 16(Paper and cardboard; printed matter; bookbinding material; photographs; stationery and office requisites, except furniture; adhesives for stationery or household purposes; drawing materials and materials for artists; paintbrushes; instructional and teaching materials; plastic sheets, films and bags for wrapping and packaging: printers' type, printing blocks), 35(Business management; business administration; business research; media relations services; advisory services for business management; business, management consultancy; business organization consultancy; professional business**COURO LIMPO SPRAY**

consultancy), 36(Financial management, financing services; financial affairs; real estate affairs; financial evaluation.) and 42(Computer programming, computer software design, computer programming services for data processing, electronic data storage, software as a service.) (526): None (730): SPACIA AFRICA PROPERTIES LIMITED of 15th Floor, The Address, Waiyaki Way, Nairobi, Kenya (740): Iseme, Kamau & Maema Advocates P.O. Box 11866 - 00400, Nairobi, Kenya

(210): 123109 (220): 07/07/2022

(300): None (511): 9(Computer operating programs, computer programs, downloadable, computer programs, recorded, computer software applications, downloadable, computer software platforms, recorded or downloadable, computer software, recorded.), 16(Paper and cardboard; printed matter; bookbinding material; photographs; stationery and office requisites, except furniture; adhesives for stationery or household purposes; drawing materials and materials for artists; paintbrushes; instructional and teaching materials; plastic sheets, films and bags for wrapping and packaging; printers' type, printing blocks.), 35(Business management; business administration; business research; media relations services; advisory services for business management; business management consultancy; business organization consultancy; professional business consultancy.), 36(Financial management, financing services; financial affairs; real estate affairs; financial evaluation.) and 42(Computer programming, computer software design, computer programming services for data processing, electronic data storage, software as a service) (526): None (730): Spacia Africa Properties Limited of 15th Floor, The Address, Waiyaki Way, Nairobi, Kenya (740): ISEME, KAMAU & MAEMA ADVOCATES ,P.O. Box 11866 - 00400 , IKM Place, Tower A, 1st Floor, 5th Ngong Avenue, Off Bishops Road, Nairobi



(210): 123154 (220): 12/07/2022

(300): None (511): 4(Non-chemical additives to motor-fuel and fuel; Solidified or liquefied gases for industrial purposes; Carburants including vehicle fuel; Liquid, solid and gas fuels, including petrol for motor engines; Fuel oil; Liquefied petroleum gas in particular butane, propane, LPG fuel; natural gas; Raw or refined petroleum; Any other fuel gases in liquid or solid form; Diesel oil; any type of fuel for gas producers, natural wood (fuel); Roasted wood (fuel); Charcoal (fuel); mixture of charcoal and mineral charcoal (fuel); Pressed vegetable mineral charcoal duff (fuel); Peat (fuel); Sawdust (fuel); petrol.), 6(Gas, butane or propane bottles (contains of metal); pipelines, pipes and tubes of metal for conveying gas; Tanks of metal, vats of metal, tanks of metal for storing gas; Steel buildings; Steel wire; Steel tubes; Reinforcing materials of metal for pipes of metal; bottles [metal containers] for compressed gas or liquid; Bottle cap of metal; bottle closures of metal; knobs of metal, non- mechanical, for flexible hoses; signboards of metal; Containers of metal for compressed gas; Packaging containers of metals; containers of metal for liquid fuel; Containers of metal for compressed gas or liquid air; Gas bottles namely containers of metal for compressed gas; Bottles and containers of metal for transporting and storing compressed gas.), 16(Printed matter; notes, letters and new bulletins; photographs; stationery; paper; cardboard; Posters; Albums; Almanacs; Cards; books; Newspapers; Prospectuses; pamphlets; Calendars; Bags (envelopes, pouches) for packaging (of paper or plastics); Stickers [stationery], tickets; Pads [stationery]; Drawing pads; Writing or drawing books; Note books; Catalogues; Newsletters; Cabinets for stationery [office requisites]; letter trays; Covers [stationery]; Document files [stationery]; Placards of paper or cardboard; wrapping paper; Envelopes [stationery]; Tear-off calendars; labels, not of textile; paper sheets [stationery]; Index

RUBIS ENERGY KENYA

cards [stationery]; Printed forms; Stencils [stationery]; Pictures; Writing paper; Booklets; Manuals [handbooks]; Periodicals; Postcards; printed publications: Ledgers [books]; Indexes; Magazines [periodicals]; Writing pads.), 35(Marketing studies and research services; advertising; business; administration; business management and organization consultancy; bill-posting; dissemination of advertising matter, direct mail advertising; organization of exhibitions for commercial or advertising purposes, organization of trade fairs and of events for commercial or advertising purposes, rental of advertising space; public relations; on-line advertising on global telecommunication networks; Providing business communication, such as direct marketing, promotion, stimulation, merchandising; organization of any promotional event and of any event driven commercialization for commercial or advertising purposes; data storage (entry); data search in computer or electronic files for others; computerized file management; compilation and systemization of information into computer databases; business management assistance and consultancy services, business information and inquiries; marketing studies; Business management.), 37(Vehicle service stations [refueling and maintenance]; Services relating to construction, installation, and maintenance of canalized networks for conveying liquefied fuel gases and petroleum gases in particular propane.), 38(Telecommunications; Telecommunications by computer network, telephone, telematic means, global telecommunication network; Services of transmission and broadcasting of data, messages, images, information and any other data by electronic means by using internet and extranet, by telematic and computer means, communication by computer terminals; Electronic mail services; Providing user access to global telecommunications networks, telecommunication site portals, telecommunication network search engines.) and 39(Distribution (delivery), transport, packaging, storage and distribution of energy, electricity and gas; Distribution (delivery), transport, packaging, storage of fuels, in particular of liquefied petroleum gases intended for household domestic installations as well as for local, professional or industrial collective installations.) (526): Registration of this mark shall give no right to the exclusive use of the words "ENERGY" and "KENYA" each separately and apart from the mark as a whole. (730): RUBIS ENERGIE of Tour Franklin, 100 Terrasse Boieldieu, 92800 Puteaux, France (740): Gichachi & Company Advocates of P. O. Box 79659 - 00200, Nairobi, Kenya

(210): 123219 (220): 15/07/2022

(300): None (511): 28(Billiard gloves; billiard cues; billiard tables; cases for billiard cues; billiard table cushions; billiard balls; billiard markers; chalk for billiard cues.) and 41(Production of radio and television programmes; video editing services for events; providing user rankings for entertainment or cultural purposes; teaching; arranging and conducting of congresses; organization of sports competitions; providing films, not downloadable, via video-on demand services; club entertainment services; club education services.) (526): Registration of this mark shall give no right to the exclusive use of the numeral "8" separately and apart from the mark as a whole. (730): QINHUANGDAO JOY BILLIARDS PROMOTION CO. LTD of Room 405, No. 6, Taichang Road, Lingang EDZ, Shanhaiguan Dist., Qinhuangdao, Hebei, China (740): Iseme, Kamau & Maema Advocates of P.O. Box 11866 - 00400, Nairobi, Kenya



(210): 123224 (220): 15/07/2022

(300): None (511): 31(Raw and unprocessed agricultural, aquacultural, horticultural and forestry products; raw and unprocessed grains and seeds; fresh fruits and vegetables, fresh herbs; natural plants and flowers; bulbs, seedlings and seeds for planting; live animals; foodstuffs and beverages for animals; malt) (526): None (730): TAMBUZI LIMITED of P. O. Box 1148 - 10400, Nanyuki, Kenya (740): None

TAMBUZI

(210): 123259 (220): 18/07/2022

(300): None (511): 35(Advertising; business management, organization and administration; office functions.) (526): Registration of this mark shall give no right to the exclusive use of the words "DUKA" and "SOFT" each separately and apart from the mark as a whole. 'Duka' is a swahili word which means 'shop'. (730): SOLUTECH LIMITED of P.O. Box 38256 - 00623, Nairobi, Kenya (740): Rehema Parmena & Co. Advocates of P.O. Box 66970 - 00200, Nairobi, Kenya

 **DukaSoft**

(210): 123263 (220): 18/07/2022

(300): None (511): 35(Advertising; business management, organization and administration; office functions.) (526): None (730): SOLUTECH LIMITED of P.O. Box 38256 - 00623, Nairobi, Kenya (740): Rehema Parmena & Co. Advocates of P.O. Box 66970 - 00200, Nairobi, Kenya



(210): 123336 (220): 21/07/2022

(300): None (511): 9(Light emitting diode [LED] displays; liquid crystal displays; flexible flat panel displays for computers; monitors; interactive touch screen terminals; electronic interactive whiteboards; electronic whiteboards; electronic pens [visual display units]; stylus pens for touch screens; tablet computers; all in one personal computer TV; computer sticks; gesture recognition software; computers; laptop computers; computer peripheral devices; monitors [computer hardware]; monitors [computer programs]; printers for use with computers; notebook computers; computer keyboards; computer mouse; interfaces for computers; bags adapted for laptops; smart glasses; computer software, recorded; computer software, downloadable; computer software applications, downloadable; computer game software, downloadable; smartwatches; stands for computer equipment; stands for computer monitors; digital signal processors; computer terminals; virtual reality training simulation software in the field of education; humanoid robots with artificial intelligence; USB flash drives; facial recognition equipment; cash registers; point-of-sale [POS] terminals; attendance machines; digital signs; electronic notice boards; network communication devices; wearable activity trackers; electro-dynamic apparatus for the remote control of signals; smartphones; radio receivers and transmitters; signal distributor; self-motion advertising machines; teaching apparatus; audio- and video-receivers; television cameras; digital video cameras; webcams; television apparatus; headphones; portable media players; pickup amplifiers; microphones; audio-video frequency converters; video processors; virtual reality glasses; security surveillance robots; set-top boxes; projection apparatus; video projectors; audiovisual teaching apparatus; teaching robots; USB cables; LED outdoor advertising displays; touch screens; LED screens; regulating apparatus, electric; transformers [electricity]; sensors [electricity]; microcontrollers; electrical adapters; power controllers; distribution boards [electricity]; distribution boxes [electricity]; fingerprint door locks; fingerprint padlocks.) (526): The claims the colors 'black, red, white, gray and red gradient'.



(730): TOP VICTORY INVESTMENTS LIMITED of Units 1208-16, 12th Floor, C-Bons International Center, 108 Wai Yip Street, Kwun Tong, Kowloon, Hong Kong **(740):** J. K. Muchae & Company Advocates of P.O. Box 60664 - 00200, Nairobi, Kenya

(210): 123359 **(220):** 22/07/2022

(300): None **(511):** 5(Preparations for destroying vermin, herbicides and fungicides.) **(526):** Registration of this mark shall give no right the exclusive use of the words 'NAFAKA', 'SUPER', 'DUST' and the devices of the 'bug' and 'cross' each separately and apart from the mark as a whole. "NAFAKA" is a Kiswahili word which means "CEREAL" in English. **(730):** SINERIA KENYA LIMITED of P. O. Box 79777 - 00200, Nairobi, Kenya **(740):** None



(210): 123436 **(220):** 26/07/2022

(300): None **(511):** 34(Tobacco; chewing tobacco; snuff; cigars; cigarettes; cigarillos; herbs for smoking; cigarette tips; tobacco pipes; cigar cutters; portable machines for rolling cigarettes; mouthpieces for cigarette holders; mouth pieces for cigar holders; cigarette filters; cigar filters; ashtrays, not of precious metal, for smokers; filter tow for cigarette; cigarette paper; cigar cases, not of precious metal; absorbent paper for tobacco pipes; lighters for smokers; cigarettes containing tobacco substitutes, not for medical purposes; electronic cigarettes; liquid nicotine solutions for use in electronic cigarettes; oral vaporizers for smokers; gas containers for cigar lighters; flavorings, other than essential oils, for use in electronic cigarettes; electronic cigarette atomizers; flavorings, other than essential oils, for tobacco; tobacco juice for electronic cigarette; electronic heating devices and electronic smoking devices, electronic cigarettes as substitutes for traditional cigarettes and electronic devices for the inhalation of nicotine-containing aerosol.) **(526):** None **(730):** CHINA TOBACCO HUNAN INDUSTRIAL CO., LTD of No. 188, Section 3, Wanjiali Middle Road, Yuhua District, Changsha Hunan, China **(740):** Simba & Simba Advocates of P. O. Box 10312 - 00100, Nairobi, Kenya

YANKER

(210): 123438 **(220):** 26/07/2022

(300): None **(511):** 34(Tobacco; chewing tobacco; snuff; cigars; cigarettes; cigarillos; herbs for smoking; cigarette tips; tobacco pipes; cigar cutters; portable machines for rolling cigarettes; mouthpieces for cigarette holders; mouth pieces for cigar holders; cigarette filters; cigar filters; ashtrays, not of precious metal, for smokers; filter tow for cigarette; cigarette paper; cigar cases, not of precious metal; absorbent paper for tobacco pipes; lighters for smokers; cigarettes containing tobacco substitutes, not for medical purposes; electronic cigarettes; liquid nicotine solutions for use in electronic cigarettes; oral vaporizers for smokers; gas containers for cigar lighters; flavorings, other than essential oils, for use in electronic cigarettes; electronic cigarette atomizers; flavorings, other than essential oils, for tobacco; tobacco juice for electronic cigarette; electronic heating devices and electronic smoking devices, electronic cigarettes as substitutes for traditional cigarettes and electronic devices for the inhalation of nicotine-containing aerosol.) **(526):** The Trade Mark consists of two Chinese characters which transliterate as 'Baisha'. 'Bai' means 'White', 'Sha' means 'Sand'. 'Bai Sha' has no meaning as a whole. **(730):** CHINA TOBACCO HUNAN INDUSTRIAL CO., LTD of No. 188, Section 3, Wanjiali Middle Road, Yuhua District, Changsha Hunan, China **(740):** Simba & Simba Advocates of P. O. Box 10312 - 00100, Nairobi, Kenya



(210): 123439 (220): 26/07/2022

(300): None (511): 34(Tobacco; chewing tobacco; snuff; cigars; cigarettes; cigarillos; herbs for smoking; cigarette tips; tobacco pipes; cigar cutters; portable machines for rolling cigarettes; mouthpieces for cigarette holders; mouth pieces for cigar holders; cigarette filters; cigar filters; ashtrays, not of precious metal, for smokers; filter tow for cigarette; cigarette paper; cigar cases, not of precious metal; absorbent paper for tobacco pipes; lighters for smokers; cigarettes containing tobacco substitutes, not for medical purposes; electronic cigarettes; liquid nicotine solutions for use in electronic cigarettes; oral vaporizers for smokers; gas containers for cigar lighters; flavorings, other than essential oils, for use in electronic cigarettes; electronic cigarette atomizers; flavorings, other than essential oils, for tobacco; tobacco juice for electronic cigarette; electronic heating devices and electronic smoking devices, electronic cigarettes as substitutes for traditional cigarettes and electronic devices for the inhalation of nicotine-containing aerosol.) (526): None (730): CHINA TOBACCO HUNAN INDUSTRIAL CO., LTD of No. 188, Section 3, Wanjiali Middle Road, Yuhua District, Changsha Hunan, China (740): Simba & Simba Advocates of P. O. Box 10312 - 00100, Nairobi, Kenya

HARMONIZATION

(210): 123451 (220): 27/07/2022

(300): None (511): 5(Pharmaceuticals.) (526): None (730): STATE BRIDGE PHARMA LIMITED of P.O. Box 6890 - 00300, Nairobi, Kenya (740): None

PULSINEURON

(210): 123582 (220): 05/08/2022

(300): None (511): 9(Computer software.) (526): None (730): BAASI SOLUTIONS LIMITED of P.O. Box 254720254686 - 00232, Ruiru, Kenya (740): Coulson Harney Advocates of P.O. Box 10643 - 00100, Nairobi, Kenya

The logo for 'Baasi' features the word 'Baasi' in a bold, yellow, sans-serif font. The letters are set against a dark, rectangular background that has a slight gradient and a drop shadow effect.

(210): 123605 (220): 08/08/2022

(300): None (511): 9(Loudspeakers; Portable media players; Materials for electricity mains [wires, cables]; Accumulators, electric; Solar panels for the production of electricity; Battery chargers; Radios; Inverters [electricity]; Headphones; Electric plugs; Electric sockets; Pocket calculators.) (526): None (730): Yiwu Winning Star Supply Chain Management Co., LTD. of Rm. 1207, No. 999, Chouzhou North Road, Yiwu City, China (740): Simba & Simba Advocates of P. O. Box 10312 - 00100, Nairobi, Kenya

NEWVEW

(210): 123613 (220): 11/08/2022

(300): None (511): 5(Pharmaceutical preparations; pharmaceutical preparations and substances used in the prevention, diagnosis, treatment and alleviation of gastrointestinal diseases and disorders; laxatives; enema preparations, medical preparations; sanitary preparations for medical purposes; dietetic food and substances adapted for medical use; dietary supplements for human beings; plasters, materials for dressings.) (526): None (730): VELINOR AG of c/o Dr. Iur. Adrian Von Segesser, Kapellplatz 1, 6004 Luzern, Switzerland (740): Ndungu Njoroge & Kwach of P.O. Box 41546 - 00100, Nairobi, Kenya

The logo for 'MOVICOL' features the word 'MOVICOL' in a light blue, rounded, sans-serif font. The letters are slightly shadowed, giving it a 3D appearance as if it's floating or attached to a surface.

(210): 123628 (220): 12/08/2022

(300): None (511): 41(Education; providing of training; entertainment; sporting; cultural activities and gambling services.) (526): Registration of this mark shall give no right to the exclusive use of the word 'LEAGUE' separately and apart from the mark as a whole. The seeks registration of the mark in the colours in which it appears but without limitation as to colour so as to be deemed to be registered for all colours as per section 19(2) of the Trade Marks Act. (730): BETIKA INTERNATIONAL LIMITED of Office 2, Suite 2, The Penthouse, Capital Business Centre, Entrance C, Triq taz-Zwejt, San Gwann SGN 3000, Malta (740): Kieti Advocates LLP of P.O. Box 22602 - 00505, Nairobi, Kenya

The logo for 'Betika League' features the word 'Betika' in a blue, bold, sans-serif font with a white outline, and the word 'League' in a yellow, bold, sans-serif font with a blue outline. Both words are set against a white background with a slight shadow.

(210): 123641 **(220):** 16/08/2022

(300): None **(511):** 5(Pharmaceutical preparations for the treatment of Chronic Hepatitis C in adults.) **(526):** None **(730):** MYLAN LABORATORIES LTD of Plot No.564/ A/22, Road No. 92, Jubilee Hills, Hyderabad - 500 034 Telangana, India **(740):** Ndungu Njoroge & Kwach of P.O. Box 41546 - 00100, Nairobi, Kenya

MyHep

(210): 123642 **(220):** 16/08/2022

(300): None **(511):** 5(Pharmaceutical preparations for the treatment of Chronic Hepatitis C in adults.) **(526):** Registration of this mark shall give no right to the exclusive use of the letters "D", "V", "I" and "R" separately and apart from the mark as a whole. **(730):** MYLAN LABORATORIES LIMITED, A company duly registered under the existing Laws of India of Plot No. 564/A/22, Road No.92, Jubilee Hills, Hyderabad 500 034 Telangana, India **(740):** Ndungu Njoroge & Kwach of P.O. Box 41546 - 00100, Nairobi, Kenya

MyHep DVIR

(210): 123643 **(220):** 16/08/2022

(300): None **(511):** 5(Pharmaceutical preparations for the treatment of Chronic Hepatitis C in adults.) **(526):** None **(730):** MYLAN LABORATORIES LIMITED, A company duly registered under the existing Laws of India of Plot No. 564/A/22, Road No.92, Jubilee Hills, Hyderabad 500 034 Telangana, India **(740):** Ndungu Njoroge & Kwach of P.O. Box 41546 - 00100, Nairobi, Kenya

Ledvir

(210): 123678 **(220):** 18/08/2022

(300): None **(511):** 9(Recordings of sound or images featuring information in the fields of securities, investment management, wealth management, investment operations, Islamic finance, corporate finance, financial compliance, risk management, derivatives and related businesses; Digital and other electronic recordings; Sound recordings; Video recordings; Downloadable electronic publications in the nature of magazines in the fields of securities, investment management, wealth management, investment operations, Islamic finance, corporate finance, financial compliance, risk management, derivatives and related businesses; Downloadable electronic newsletters and documents in the fields of securities, investment management, wealth management, investment operations, Islamic finance, corporate finance, financial compliance, risk management, derivatives and related businesses.), 16(Stationery; Printed instructional and teaching material in the fields of securities, investment management, wealth management, investment operations, Islamic finance, corporate finance, financial compliance, risk management, derivatives and related businesses; books, newsletters, leaflets, magazines in the fields of securities, investment management, wealth management, investment operations, Islamic finance, corporate finance, financial compliance, risk management, derivatives and related businesses.) and 41(Education services, namely, classes, seminars, conferences, symposiums, workshops in the fields of securities, investment management, wealth management, investment operations, Islamic finance, corporate finance, financial compliance, risk management, derivatives and related businesses; Providing of training services in the fields of securities, investment management, wealth management, investment operations, Islamic finance, corporate finance, financial compliance, risk management, derivatives and related businesses; Publication of books in the fields of securities, investment management, wealth management, investment operations, Islamic finance, corporate finance, financial compliance, risk management, derivatives and related businesses; Arranging and conducting of conferences, seminars, symposiums, workshops and events in the fields of securities, investment management, wealth management, investment operations, Islamic finance, corporate finance, financial compliance, risk management, derivatives and related businesses; organization of webinars; Organization of

CHARTERED INSTITUTE FOR SECURITIES
AND INVESTMENT

educational events in the fields of securities, investment management, wealth management, investment operations, Islamic finance, corporate finance, financial compliance, risk management, derivatives and related businesses; Providing education in the fields of securities, investment management, wealth management, investment operations, Islamic finance, corporate finance, financial compliance, risk management, derivatives and related businesses; Production of video recordings in the fields of securities, investment management, wealth management, investment operations, Islamic finance, corporate finance, financial compliance, risk management, derivatives and related businesses.) (526): Registration of this mark shall give no right to the exclusive use of the words "FOR", "AND", "CHARTERED", "INSTITUTE", "SECURITIES" and "INVESTMENT" each separately and apart from the mark as a whole. (730): CHARTERED INSTITUTE FOR SECURITIES AND INVESTMENTS of 20 Frechurch Street, London, EC3M 3BY., United Kingdom (740): Njuguna Kamau Okoth Advocates of P.O. Box 36463 - 00200, Nairobi, Kenya

(210): 123689 (220): 19/08/2022

(300): None (511): 16(Paper and cardboard; Printed matter; bookbinding material; photographs; Stationery and office requisites, except furniture; Adhesives for stationery or household purposes; drawing materials and materials for artists; Paintbrushes; Instructional and teaching materials; Plastic sheets, films and bags for wrapping and packaging; Printers' type, printing blocks.), 25(Clothing, footwear, headwear.) and 41(Education; Providing of training; Entertainment; Sporting and cultural activities.) (526): None (730): THE AGA KHAN UNIVERSITY - KENYA of P.O. Box 30270 - 00100, Nairobi, Kenya (740): Oraro & Company Advocates of P.O. Box 51236 - 00200, Nairobi, Kenya



(210): 123690 (220): 19/08/2022

(300): None (511): 16(Paper and cardboard; printed matter; bookbinding material; photographs; stationery and office requisites, except furniture; adhesives for stationery or household purposes; drawing materials and materials for artists; paintbrushes; instructional and teaching materials; plastic sheets, films and bags for wrapping and packaging; printers' type, printing blocks.), 25(Clothing, footwear, headwear.) and 41(Education; Providing of training; Entertainment; Sporting and cultural activities.) (526): None (730): THE AGA KHAN UNIVERSITY - KENYA of P.O. Box 30270 - 00100, Nairobi, Kenya (740): Oraro & Company Advocates of P.O. Box 51236 - 00200, Nairobi, Kenya



(210): 123692 (220): 19/08/2022

(300): None (511): 32(Non-alcoholic beverages; Mineral and aerated waters; Fruit beverages and fruit juices; Syrups and other non-alcoholic preparations for making beverages.) (526): The applicant wishes to restrict the above mark in colours Black with green leaf. (730): Ceres Fruit Juices (Pty) Ltd of Glacier Place, 1 Sportica Crescent, Tygervalley, Bellville, 7530, South Africa (740): Kaplan & Stratton Advocates of P.O. Box 40111 - 00100, Nairobi, Kenya



(210): 123784 (220): 24/08/2022

(300): None (511): 5(Preparations for killing weeds and destroying vermin; Insecticides; Moth proofers; Insect repellents; Fungicides; Rodenticides.) (526): Registration of this mark shall give no right to the exclusive use of the words "MOSQUITO" and "SHIELD", the letter "C" and "S" each separately and apart from the mark as a whole. (730): S. C. Johnson & Son, Inc. of 1525 Howe Street Racine, Wisconsin 53403 - 2236, United States of America (740): J.K. Muchae & Company Advocates of P.O. Box 60664 - 00200, Nairobi, Kenya



(210): 123786 **(220):** 24/08/2022

(300): None **(511):** 12(Vehicles.) **(526):** Registration of this mark shall give no right to the exclusive use of the letters "D", "S" and "Y" each separately and apart from the mark as a whole. The trade mark is an initial of the business name DYS (De Young Shall Grow Motors Limited) **(730):** OKOYE PELE CHUKWUGOZIE of P.O. Box 52399 - 00200, Nairobi, Kenya **(740):** None



(210): 123825 **(220):** 26/08/2022

(300): None **(511):** 3(Bleaching preparations and other substances for laundry use; cleaning, polishing, scouring and abrasive preparations; soaps; perfumery, essential oils, cosmetics, hair lotions, shampoos; dentifrices.), 9(Spectacles; glasses; sunglasses; cases, chains, frames and lenses for spectacles, glasses and sunglasses.), 14(Precious metals and their alloys and goods in precious metals or coated therewith, not included in other classes; jewellery, precious stones; horological and chronometric instruments; watches.), 18(Leather and imitations of leather; animal skins and hides; luggage and carrying bags, wallets and purses; umbrellas and parasols; walking sticks; whips, harness and saddlery; collars, leashes and clothing for animals.), 25(Clothing, footwear, headgear.) and 35(Retail and wholesale services; retail and wholesale services for cosmetics, perfumery, spectacles, sunglasses, jewellery, watches, leather goods, carrying bags, wallets, purses, clothing, footwear and headgear.) **(526):** None **(730):** TRUWORTHS LIMITED of 1 Mostert Street, Cape Town, 8001, South Africa **(740):** Ndungu Njoroge & Kwach Advocates of P. O. Box 41546 - 00100, Nairobi, Kenya



(210): 123885 **(220):** 01/09/2022

(300): None **(511):** 5(Nutritional preparations and substances; All for parenteral (intravenous or intraperitoneal) or enteral administration; Combined glucose and amino acid solutions.) **(526):** None **(730):** BAXTER INTERNATIONAL INC of One Baxter Parkway, Deerfield, Illinois 60015, United States of America **(740):** Coulson Harney Advocates of P.O. Box 10643 - 00100, Nairobi, Kenya

OLIMEL

(210): 123913 **(220):** 05/09/2022

(300): None **(511):** 5(Mineral supplement for Livestock.) **(526):** None "JOTO" is a Kiswahili word meaning "Heat" in English. **(730):** HIGHCHEM MARKETING LTD. of P.O. Box 30467 - 00100, Nairobi, Kenya **(740):** None

HIGHCHEM JOTO

(210): 123928 **(220):** 05/09/2022

(300): None **(511):** 34(Tobacco and tobacco substitutes; cigarettes and cigars; electronic cigarettes and oral vaporizers for smokers; smokers' articles; matches.) **(526):** Registration of this mark shall give no right to the exclusive use of the words "ROYAL", "ESTABLISHED", the letter "R" and the year "1845" each separately and apart from the mark as a whole. **(730):** PREMIUM INTERNATIONAL HOLDING LTD of Trident Chambers, P.O. Box 146, Road Town, Tortola, Virgin Islands (British) **(740):** Ndungu Njoroge & Kwach of P. O. Box 41546 - 00100, Nairobi, Kenya



(210): 123964 **(220):** 08/09/2022

(300): None **(511):** 9(Apparatus for recording, transmission or reproduction of sound or images; magnetic data carriers, recording discs; compact discs, DVDs and other digital recording media; data processing equipment, computer software; computer software for accessing, bookmarking, browsing, collecting, finding, manipulating, organizing, renting, and storing audio, data, video, game, and multimedia files; computer software for accessing subscription-based digital media content; computer software for use in editing, extracting, encoding, decoding, storing and organizing data, images, audio, video, and multimedia files; computer software for creating

AMAZON FREEVEE

and providing user access to searchable databases of information and data files; search engine software; computer software for accessing online information; computer software for use in disseminating advertising for others; computer software for renting and purchasing movies, TV shows, videos, music, and multimedia files; computer software for use in sharing information about products, services, and deals; computer software for electronic storage of data; computer software for image and speech recognition; computer software for home automation; internet browser software; downloadable mobile applications to enable users to access, bookmark, browse, collect, find, manipulate, organize, rent, and store music, audio, video, games, audiovisual, multimedia files; computer software for the collection, organizing, modifying, book marking, and storage of data and information; computer software for online shopping; computer software for information management; computer programs for accessing, browsing, and searching online databases; computer operating system software; computer software for configuring, operating and controlling devices, computers, computer peripherals, and audio and video players; computer software for creating searchable databases of information; computer game software; computer software that generates customized recommendations based on user vehicles; voice recording and voice recognition apparatus; network communication apparatus; electronic communication equipment and instruments;; cameras; camcorders; cinematographic cameras; cases especially made for photographic apparatus and instruments; centering apparatus for photographic transparencies; close-up lenses; projection screens; projection apparatus; stereo systems, home theater systems, and home entertainment systems; information technology and audiovisual equipment; intercommunication apparatus; smartphones; portable telephones; telephone apparatus; video telephones; computer memory devices; microprocessors; modems; 3D spectacles; straps, armbands, lanyards and clips for portable and handheld digital electronic devices for recording organizing, manipulating, and reviewing data, audio, image and video files; bags and cases adapted or shaped to contain digital music and/or video players, hand held computers, personal digital assistants, electronic organizers and electronic notepads; user manuals in electronically readable, machine readable or computer readable form for use with, and sold as a unit with, the aforesaid goods.), 38(Telecommunications; Electronic communication services, namely, transmission of information by electronic communications networks; electronic transmission of data, audio, video, and audio/video files; wireless broadband communications services; broadcasting services; video communication services, namely broadcasting, streaming, and transmitting videos, images, music audio, multimedia over the Internet or other communications network; data streaming; consultancy and advisory services relating to telecommunications services; computer services, namely, providing multiple-user access to computer networks for the electronic transmission of various data, communications, documents and personal and professional information; providing access to an interactive computer database featuring automatically updating address book, personal planner, date reminder, travel planner, and alumni and professional group links, via a global computer network; providing a web site that gives computer users the ability to transmit, cache, receive, download, stream, broadcast, display, format, transfer and share content, visual works, audio works, audiovisual works, literary works, photos, videos, data, files, documents, images and other electronic works; providing an on-line link to current events and reference material relating to movies, motion pictures, documentaries, films, television

programs, graphics, animation and multimedia presentations, videos and DVDs and other audiovisual works; transmission of podcasts; Video-on-demand transmission; Internet protocol television (IPTV) transmission services; electronic transmission of streamed and downloadable audio and video files via computer and other communications networks; electronic transmission and streaming of digital media content for others via global and local computer networks; telecommunication services, namely, transmission and streaming of voice, data, images, films, television programs, audio and audiovisual programs and other digital media content and information by means of telecommunications networks, wireless communication networks, and the internet; streaming of audio, video and audiovisual material on the Internet, communications networks and wireless telecommunications networks; streaming of data; streaming of music, films, movies, TV shows and games on the Internet; audio and video broadcasting services; broadcasting of cinematographic films and audiovisual programs; subscription-based audio and video broadcasting services over the Internet; broadcasting services and provision of telecommunication access to films, television programs, audio and audiovisual programs and other digital media content and information, provided via a video-on-demand service; Internet broadcasting services; Internet radio broadcasting services; telecommunication services, namely, transmission of webcasts; transmission of digital files ; transmission of digital content by computer networks, the Internet, DSL, cable networks, digital download, digital streaming, video-on-demand, near-video-on-demand, TV, free-to-air TV, pay-per-view TV, satellite, cable, telephone or mobile telephone; electronic transmission of digital photo files among Internet users; providing access to online directories, databases, websites, blogs, music, video programs, and reference materials; transmission of news; delivery of messages by electronic transmission; electronic transmission of mail and messages; podcasting services; providing on-line chat rooms for social networking; providing an on-line forum for transmission of messages among computer users and the transmission of photos, videos, data, images and sound; telecommunications services, namely, providing online electronic bulletin boards for the transmission of messages among computer users concerning entertainment; providing telecommunication connectivity services for the transfer of images, audio, visual, audiovisual and multimedia works among mobile phones, smartphones, portable electronic devices, portable digital devices, tablets, or computers; transmission of television and movie guides; communication between computers; provision of access time to multimedia materials on the Internet; provision of telecommunications connections to computer databases; transmission of data by audio-visual apparatus controlled by data processing apparatus or computers; telecommunications routing and junction services; rental of access time to global computer networks; transmission of greeting cards online; rental of message sending apparatus; rental of modems; rental of telecommunication equipment.) and 41(Education; providing of training; entertainment; sporting and cultural activities; entertainment services, namely, providing online non-downloadable audio, video, and multimedia files; entertainment services, namely, providing online non-downloadable audio, video and audiovisual content in the nature of audio, video, and multimedia recordings; entertainment services, namely, providing temporary use of online non-downloadable audio, video, and multimedia files; computerized on-line searching and ordering service featuring audio, video, and multimedia files, and other audiovisual works in the form of digital non-downloadable entertainment content; creating and developing concepts for

entertainment and educational programs; entertainment and educational services, namely, uploading, downloading, capturing, posting, showing, editing, playing, streaming, viewing, previewing, displaying, tagging, blogging, sharing, manipulating, distributing, publishing, reproducing, or otherwise providing electronic media, multimedia content, videos, movies, pictures, images, text, photos, games, user generated content, audio content, and information via the internet or other computer and communications networks; providing a searchable on-line entertainment database featuring on-line non-downloadable music, movies, television shows, multimedia presentations in the field of entertainment, audio files featuring music, comic books, and publications in the nature of entertainment; providing a video sharing portal for entertainment and education purposes, entertainment services, featuring electronic media, multimedia content, videos, movies, pictures, images, text, photos, user-generated content, audio content, and related information via computer and communications networks; providing a video-on-demand website featuring non-downloadable movies and films; providing a website featuring non-downloadable videos in the field of movies, television shows, and film trailers on a variety of topics; providing current event news and information in the field of entertainment relating to contests, video, audio and prose presentations and publications all in the field of entertainment; providing on-line reviews of television shows and movies; providing online videos, not downloadable; providing information on entertainment, movies and television shows via social networks; provision of non-downloadable television shows and other audiovisual works via a video-on-demand service; television entertainment; television entertainment, namely, ongoing television programs featuring pop culture, television shows, films, and celebrity stories on a variety of topics; audio and video recording services; digital audio, video and multimedia publishing services; online non-downloadable prerecorded music and audio programs featuring fiction and non-fiction stories on a variety of topics; entertainment services, namely, live visual and audio performances, musical, variety, news, dramatic and comedy shows; ratings and reviews of entertainment program content; entertainment information; providing online news, information and commentary in the field of entertainment; online journals, namely, blogs featuring information about entertainment; arranging of contests; sweepstake services; hosting online sweepstakes and contests for others; publishing of books, magazines, periodicals, literary works, visual works, audio works, and audiovisual works; music production services; music publishing services; entertainment services, namely, profiling of musicians, artists and bands via non-downloadable video clips; providing non-downloadable interactive resource for searching, selecting, managing, and viewing audiovisual content in the nature of audio, video, and multimedia recordings; providing online newsletters in the field of television, movies, and videos via e-mail; translation and interpretation services; providing online electronic publications, not downloadable; publication of texts, other than publicity texts; writing of texts, other than publicity texts; rental of audio equipment; movie theatre presentations; arranging and conducting of concerts; entertainment, amusements; games equipment rental; arranging and conducting of games; providing karaoke services; rental of movie projectors and accessories; movie studios; music composition services; organization of shows; production of radio programs; production of podcasts; production of video podcasts; providing entertainment via podcasts and radio programs; providing entertainment via a website; providing entertainment via a downloadable app; rental of audio, video, and multimedia recordings; subtitling; theatre productions;

organization of competitions; organization of exhibitions for cultural or educational purposes; recording studio services; videotape editing; videotaping; education information; teaching, educational services, instruction services; entertainment services, namely, production and distribution of television programs and other audiovisual works featuring commentary, stories, news, interviews, television shows, films, music and pop culture; entertainment services, namely, visual and audio performances, musical, variety, news, dramatic and comedy shows rendered live; film production, other than advertising films; production of radio and television programmes; production and rental of audio-visual recordings, specifically, motion pictures, television programming, videos, music videos, and music in the fields of news, entertainment, sports, comedy, drama, music, and music videos; provision of on-line, non-downloadable electronic publications, namely, books, magazines, newspapers, periodicals, newsletters, journals, manuals, and video recordings on a variety of topics, namely, theatre, movies, television shows, sports, sports instruction, recreational activities, leisure activities, tournaments, art, dance, musicals, art exhibitions, science exhibitions, entertainment exhibitions, sport clubs, hobby clubs, social clubs, radio, comedy, contests, games, gaming, festivals, museums, parks, cultural events, concerts, publishing, animation, current events, fashion shows, history, language, liberal arts, math, business, science, technology, hobbies, culture, sports, arts, psychology, and philosophy; production of shows.) **(526)**: None **(730)**: AMAZON TECHNOLOGIES, INC. of 410 Terry Avenue North, Seattle, Washington 98109, United States of America **(740)**: Muthoni Advocates of P.O. Box 28397 - 00200, Nairobi, Kenya

(210): 123971 **(220)**: 08/09/2022

(300): None **(511)**: 19(Building materials (non-metallic); Non-metallic rigid pipes for building; Asphalt, pitch and bitumen; Non-metallic transportable buildings; Monuments, not of metal.) **(526)**: Registration of this mark shall give no right to the exclusive use of the letters "M", "D", "F" and the device of a "tree trunk" each separately and apart from the mark as a whole. The mark is proceeding in series. **(730)**: RAI MDF LIMITED of P.O. Box 2917 - 20100, Nakuru, Kenya **(740)**: O&M Law LLP of P.O. Box 49393 - 00100, Nairobi, Kenya



(210): 123997 **(220)**: 09/09/2022

(300): None **(511)**: 35(Advertising; Business management; Business administration; Office functions.) and 36(Insurance products.) **(526)**: Registration of this mark shall give no right to the exclusive use of the word "TRAVELLER" separately and apart from the mark as a whole. **(730)**: THE HERITAGE INSURANCE COMPANY LIMITED of Liberty House, Processional Way, P.O. Box 30390 - 00100, Nairobi, Kenya **(740)**: None



(210): 123999 **(220)**: 09/09/2022

(300): None **(511)**: 35(Advertising; Business management; Business administration; Office functions.) and 36(Insurance products.) **(526)**: Registration of this mark shall give no right to the exclusive use of the word "BLUE" separately and apart from the mark as a whole. **(730)**: THE HERITAGE INSURANCE COMPANY LIMITED of Liberty House, Processional Way, P.O. Box 30390 - 00100, Nairobi, Kenya **(740)**: None



(210): 124015 **(220):** 12/09/2022

(300): None **(511):** 16(Paper and cardboard; Printed matter; Bookbinding material; Photographs; Stationery and office requisites, except furniture; Adhesives for stationery or household purposes; drawing materials and materials for artists; Paintbrushes; Instructional and teaching materials; Plastic sheets, films and bags for wrapping and packaging; Printers' type, printing blocks.), 25(Clothing, footwear, headwear.) and 41(Education; Providing of training; Entertainment; Sporting and cultural activities.) **(526):** Registration of this mark shall give no right to the exclusive use of the device "Leopards head" separately and apart from the mark as a whole. **(730):** THE AGA KHAN UNIVERSITY - KENYA of P.O. Box 30270 - 00100, Nairobi, Kenya **(740):** Oraro & Company Advocates of P.O. Box 51236 - 00200, Nairobi, Kenya



(210): 124021 **(220):** 12/09/2022

(300): None **(511):** 9(Scientific, research, navigation, surveying, photographic, cinematographic, audiovisual, optical, weighing, measuring, signalling, detecting, testing, inspecting, life-saving and teaching apparatus and instruments; apparatus and instruments for conducting, switching, transforming, accumulating, regulating or controlling the distribution or use of electricity; apparatus and instruments for recording, transmitting, reproducing or processing sound, images or data; recorded and downloadable media, computer software, blank digital or analogue recording and storage media; mechanisms for coin-operated apparatus; cash registers, calculating devices; computers and computer peripheral devices; diving suits, divers' masks, ear plugs for divers, nose clips for divers and swimmers, gloves for divers, breathing apparatus for underwater swimming; fire-extinguishing apparatus.), 35(Advertising; business management, organization and administration; office functions.), 36(Financial, monetary and banking services; Insurance services; Real estate affairs.), 38(Telecommunications services.) and 42(Scientific and technological services and research and design relating thereto; industrial analysis, industrial research and industrial design services; quality control and authentication services; design and development of computer hardware and software.) **(526):** None **(730):** FIRSTRAND BANK LIMITED, a South African public company of 4th Floor 4 Merchant Place, Cnr. Fredman Drive & Rivonia Road, Sandton, Gauteng, South Africa **(740):** Coulson Harney Advocates of P.O. Box 10643 - 00100, Nairobi, Kenya



(210): 124022 **(220):** 12/09/2022

(300): None **(511):** 9(Scientific, research, navigation, surveying, photographic, cinematographic, audiovisual, optical, weighing, measuring, signalling, detecting, testing, inspecting, life-saving and teaching apparatus and instruments; apparatus and instruments for conducting, switching, transforming, accumulating, regulating or controlling the distribution or use of electricity; apparatus and instruments for recording, transmitting, reproducing or processing sound, images or data; recorded and downloadable media, computer software, blank digital or analogue recording and storage media; mechanisms for coin-operated apparatus; cash registers, calculating devices; computers and computer peripheral devices; diving suits, divers' masks, ear plugs for divers, nose clips for divers and swimmers, gloves for divers, breathing apparatus for underwater swimming; fire-extinguishing apparatus.), 35(Advertising; Business management, organization and administration; Office functions.), 36(Financial, monetary and banking services; Insurance services; Real estate affairs.), 38(Telecommunications services.) and 42(Scientific and technological services and research and design relating thereto; Industrial analysis, industrial research and industrial design services; Quality control and authentication services; Design and development of computer hardware and



software.) (526): None (730): FIRSTRAND BANK LIMITED, a South African public company of 4th Floor 4 Merchant Place, Cnr. Fredman Drive & Rivonia Road, Sandton, Gauteng, South Africa (740): Coulson Harney Advocates of P.O. Box 10643 - 00100, Nairobi, Kenya

(210): 124045 (220): 15/09/2022

(300): None (511): 31(Animal feeds.) (526): Registration of this mark shall give no right to the exclusive use of the word "PRODUCTS" separately and apart from the mark as a whole. (730): JUMBO FEEDS LTD of P.O. Box 16164 - 00100, Kenya (740): None



STACI

(210): 124107 (220): 20/09/2022

(300): None (511): 9(Scientific, nautical. surveying, photographic, cinematographic, optical, weighing, measuring, signaling, checking (supervision), life-saving and teaching apparatus and instruments; electric and electronic apparatus and hardware r equipment for the storage and transmission of data and information for use in relation to banking, financial. insurance and general commercial transactions, including those conducted online via the Internet or a computer network, or by telephone or cellular telephone; software, systems, devices and platforms used to enable and facilitate electronic banking, financial. insurance or other commercial transactions, including those via the Internet or a computer network, or by telephone or cellular telephone; including data processing equipment and software for use in relation to banking and financial services including data processing equipment and software; downloadable electronic publications; apparatus and equipment for the electronic transfer of and/or financial data; telecommunication equipment; automated teller machines; money dispensing machines, electronic fund transfer, payment or point of sale apparatus, machines and terminals; card and bar code scanners magnetic and magnetically encoded cards; programmable cards; smart cards; cards bearing coded data in magnetic form; cards bearing data for use in computers; cards bearing coded data in punched- out form; cards bearing data for use in data processing apparatus; cards bearing data for use in data storage apparatus; cards bearing electronically recorded data; cards bearing integrated circuits; cards bearing magnetic or encoded data for input; cards bearing micro-chips and computer cards containing chips; credit, charge, debit and/or cash cards; prepayment cards [encoded]; loyalty or gift cards [encoded], readers, scanners, parts and fittings for the aforementioned goods.), 35(Advertising; business management; business administration; office functions; facilitation of commercial and business transactions, including those conducted online via the Internet or a computer network, or by telephone or cellular telephone; business strategy services; business appraisal and analysis services; database management services; provision of business and commercial advice and information provided by telephone or provided on-line from a computer database, computer network, global computer network or the Internet; business planning; business strategy services, business appraisals; business management assistance; business support; accounting; economic forecasting and analysis for business purposes; profit and cash flow forecasting, analysis and planning, all being economic forecasting services; personnel management and employment consultancy; database management services, data processing, data verification and file management; computerised business information storage and retrieval; credit card registration services; procurement of goods and services on behalf of businesses; purchasing of goods and services for other businesses; business administration services for the processing of sales and transactions made on a global computer network or the Internet; the bringing together, for the benefit of others, of a variety of goods including but not limited to, business

equipment, enabling customers to conveniently view and purchase those goods from a computer network website or an Internet website; offering for sale and the sale of goods in the retail and wholesale trade; customer loyalty reward schemes, customer care services; advisory, consultancy, information and helpline services relating to all of the aforesaid services ancillary or related to the aforementioned all in class 35.), 36(Insurance products and services; financial affairs; monetary affairs; real estate affairs; banking services; payment facilitation services, facilitation and rendering of banking and financial transactions, including those rendered online via the Internet or computer network, or by telephone or cellular telephone; services ancillary and related to all of the foregoing, all in class 36.), 38(Telecommunications and communications services; providing user access to computer networks or the Internet for purposes of facilitating commercial. banking or financial transactions and electronic payments; providing telecommunications connections to the Internet or data bases for purposes of facilitating commercial. banking or financial transactions and electronic payments services ancillary and related to all of the foregoing, all in class 38.) and 42(Scientific and technological services and research and design relating thereto; industrial analysis and research services; IT services, design and development of computer hardware and software and computer systems; operation of websites and online transactional platforms; rental of computer hardware and software; leasing of access time to computer database; advisory, information, evaluations, consultancy services; services ancillary and related to all of the foregoing, all in class 42.) **(526):** None **(730):** THE STANDARD BANK OF SOUTH AFRICA LIMITED of 5 Simmonds Street Johannesburg, 2001, Gauteng, South Africa **(740):** Coulson Harvey Advocates of P.O. Box 10643 - 00100, Nairobi, Kenya

(210): 124126 **(220):** 21/09/2022

(300): None **(511):** 5(Ophthalmic preparations.) **(526):** None **(730):** Allergan, Inc. CORPORATION Delaware, United States of 1 N. Waukegan Road, North Chicago, Illinois 60064, United States of America **(740):** J.K. Muchae & Co Advocates of P.O. Box 60664 - 00200, Nairobi, Kenya

ACULAR

(210): 124128 **(220):** 21/09/2022

(300): None **(511):** 5(Pharmaceutical preparations for the treatment of glaucoma.) **(526):** None **(730):** ALLERGAN, INC. of 1 N. Waukegan Road, North Chicago, Illinois 60064, United States of America **(740):** J. K. Muchae & Company Advocates of P.O. Box 60664 - 00200, Nairobi, Kenya

COMBIGAN

(210): 124143 **(220):** 22/09/2022

(300): None **(511):** 5(Pharmaceuticals, medical and veterinary preparations; sanitary preparations for medical purposes; dietetic food and substances adapted for medical or veterinary use, food for babies; dietary supplements for humans and animals; plasters, materials for dressings; material for stopping teeth, dental wax; disinfectants; preparations for destroying vermin; fungicides, herbicides.) **(526):** The word 'IMIWOK' is a unique word with no special meaning in any language. Therefore, no English translation is available or applicable. **(730):** WOCKHARDT LIMITED of Wockhardt Towers, Bandra Kurla Complex, Mumbai - 400051, India **(740):** Gikera and Vadgama Advocates of P.O. Box 720 - 00621, Nairobi, Kenya

IMIWOK

(210): 124144 **(220):** 22/09/2022**(300):** None **(511):** 5(Pharmaceuticals, medical and veterinary preparations; sanitary preparations for medical purposes; dietetic food and substances adapted for medical or veterinary use, food for babies; dietary supplements for humans and animals; plasters, materials for dressings; material for stopping teeth, dental wax; disinfectants; preparations for destroying vermin; fungicides, herbicides.) **(526):** The word 'IOWOK' is a unique word with no special meaning in any language. Therefore, no English translation is available or applicable. **(730):** WOCKHARDT LIMITED of Wockhardt Towers, Bandra Kurla Complex, Mumbai - 400051, India **(740):** Gikera and Vadgama Advocates of P.O. Box 720 - 00621, Nairobi, Kenya**IOWOK****(210):** 124172 **(220):** 22/09/2022**(300):** None **(511):** 9(Downloadable mobile applications; Computer website platform; Computer programs (downloadable software); Video recorders; Monitoring apparatus, electric; cameras (photography); data processing equipment; integrated circuit cards and components; alarms; Face recognition equipment; Attendance machine; Network Communication Equipment; detectors; sensors; electronic displays; electric wire.) **(526):** None **(730):** HANGZHOU HIK VISION DIGITAL TECHNOLOGY CO., LTD of No. 555 Qianmo Road, Binjiang District, Hangzhou, 310051, P.R, China **(740):** Kaplan & Stratton Advocates of P.O. Box 40111 - 00100, Nairobi, Kenya**HIK-PARTNER****(210):** 124173 **(220):** 22/09/2022**(300):** None **(511):** 9(Downloadable mobile applications; Computer website platform; Computer programs (downloadable software); Video recorders; Monitoring apparatus, electric; cameras (photography); data processing equipment; integrated circuit cards and components; alarms; Face recognition equipment; Attendance machine; Network Communication Equipment; detectors; sensors; electronic displays; electric wire.) **(526):** The wishes to restrict the above mark to colours red and white. **(730):** HANGZHOU HIK VISION DIGITAL TECHNOLOGY CO., LTD of No. 555 Qianmo Road, Binjiang District, Hangzhou, 310051, P.R. China **(740):** Kaplan & Stratton Advocates of P.O. Box 40111 - 00100, Nairobi, Kenya**(210):** 124174 **(220):** 22/09/2022**(300):** None **(511):** 35(Analysis and consulting services in the field of business information management, namely, business analysis, business enterprise modeling, and business information organization; developing, arranging and conducting trade shows in the fields of computers, software, information technology, and cloud services development; on-line retail store services in the field of computer programs for business, entertainment, scientific, technical, commercial, educational and personal computing uses, and printed material related thereto.) **(526):** None **(730):** ORACLE INTERNATIONAL CORPORATION, U.S.A Corporation of 500 Oracle Parkway, Redwood City, California, 96065, United States of America **(740):** Kaplan & Stratton Advocates of P.O. Box 40111 - 00100, Nairobi, Kenya**ORACLE****(210):** 124175 **(220):** 22/09/2022**(300):** None **(511):** 32(Mineral and aerated waters.) **(526):** Registration of this mark shall give no right to the exclusive use of the word "Water", the letters "I", "L", "P" and the device of "water drop" each separately and apart from the mark as a whole. "PIMIT" is Dholuo word meaning "SWEET" **(730):** SAVAHOPE LIMITED of P.O. Box 60038 - 00200, Nairobi, Kenya **(740):** None

(210): 124185 **(220):** 23/09/2022

(300): None **(511):** 9(Computers; Data processing apparatus; Computer memory devices; Computer keyboards; Bar code readers; Computer operating programs, recorded; Computer peripheral devices; Computer software, recorded; Interfaces for computers; Monitors [computer hardware]; Monitors [computer programs]; Mouse [computer peripheral]; Printers for use with computers; Central processing units [processors]; Readers [data processing equipment]; Scanners [data processing equipment]; Disk drives for computers; Notebook computers; Computer software applications, downloadable; Computer software platforms, recorded or downloadable; Downloadable ring tones for mobile phones; Downloadable music files; Computer screen saver software, recorded or downloadable; Computer game software, downloadable; Computer game software, recorded; Mouse pads; Laptop computers; Devices for the projection of virtual keyboards; Weighing machines; Weighing apparatus and instruments; Antennas; Telephone receivers; Transmitters of electronic signals; Transmitting sets [telecommunication]; Intercommunication apparatus; Masts for wireless aerials; Mobile telephones; Telephone transmitters; Video telephones; Cordless telephones; Hands-free kits for telephones; Cell phone straps; Cabinets for loudspeakers; Loudspeakers; Sound recording apparatus; Audio- and video-receivers; Microphones; Sound reproduction apparatus; Television apparatus; Camcorders' Personal stereos; Headphones; Portable media players; Cameras [photography]; Optical data media; Cables, electric; Wires, electric; Coaxial cables; Fibre optic cables; Amplifiers; Rearview cameras for vehicles; Electric sockets; Interactive touch screen terminals; USB flash drives; Inverters [electricity]; Voltage surge protectors; Light-emitting diodes [LED]; Alarms; Sound alarms; Fire alarms; Alarm bells, electric; Theft prevention installations, electric; Anti-theft warning apparatus; Battery chargers; Batteries, electric; Solar batteries; Video screens; Subwoofers; Radios; Horns for loudspeakers; telephone apparatus.) **(526):** None **(730):** MEERA INTERNATIONAL LIMITED of Room 301, Kam On Building, 176A Queen's Road Central, Central, Hong Kong **(740):** Gichachi & Company Advocates of P.O. Box 79659 - 00200, Nairobi, Kenya

(210): 124212 **(220):** 26/09/2022

(300): None **(511):** 9(Scientific, nautical, surveying, photographic, cinematographic, optical, weighing, measuring, signalling, checking (supervision), life-saving and teaching apparatus and instruments; apparatus and instruments for conducting, switching, transforming, accumulating, regulating or controlling electricity; apparatus for recording, transmission or reproduction of sound or images; magnetic data carriers, recording discs; compact discs, DVDs and other digital recording media; mechanisms for coin-operated apparatus; cash registers, calculating machines, data processing equipment, computers; computer software; fire-extinguishing apparatus.), 28(Games, toys and playthings; video game apparatus.), 35(Advertising; business management; business administration; office functions. retail stores; online stores; organization of trade fairs and exhibitions for commercial or advertising purposes; organization of fashion shows for promotional purposes; online retail services for downloadable digital music; retail services for works of art provided by art galleries.), 36(Insurance; financial affairs; monetary affairs; real estate affairs.), 38(Telecommunications.), 41(Education; providing of training; entertainment; sporting and cultural activities; organization of fashion shows for entertainment purposes; music composition services; providing online music, not downloadable.) and 42(Scientific and technological services and research and design relating thereto; industrial analysis and research



services; design and development of computer hardware and software.) (526): None (730): DUBAI WORLD TRADE CENTRE LLC of P. O. Box 9292, Dubai, United Arab Emirates (740): CFL Advocates of P. O. Box 23555 - 00100, Nairobi, Kenya

(210): 124235 (220): 27/09/2022

(300): None (511): 3(Bleaching preparations and other substances for laundry use; cleaning, polishing, scouring and abrasive preparations; soaps; perfumery, essential oils, cosmetics, hair lotions; dentifrices) (526): 'OVSEN' is a coined word and logo with known meaning (730): LIU LEI of P. O. Box 18220 - 00500, Nairobi, Kenya (740): None



(210): 124240 (220): 27/09/2022

(300): None (511): 3(Cosmetic products and facial makeup preparations.) (526): None (730): L'OREAL a company organised and existing under the laws of France of 14 Rue Royole, 75008, Paris, France (740): Iseme, Kamau & Maema Advocates of P.O. Box 11866 - 00400, Nairobi, Kenya

MAYBELLINE FIT ME

(210): 124257 (220): 28/09/2022

(300): None (511): 3(Non-medicated facial and body skin care products, namely, cleansers, lotions, creams, disposable wipes impregnated with chemicals or compounds for personal hygiene, wipes and pads, scrubs, moisturizers, and sunscreen; facial masks; facial peels; anti-aging creams and non-medicated anti-aging serums; shave gel; Suntan lotion, namely, sunscreen; Non-medicated chest rub in the nature of skin creams not for medical or therapeutic use; non-medicated diaper rash lotions, ointments, and creams; Cosmetics, namely, bronzers, lip liner, lip gloss, lip balm, lip color and lip primers, liquid foundation, compact foundation and face powder, mascara, eye shadow, eye liner, make-up remover; Hair care preparations; hair care products, namely, shampoos, conditioners, gels, mousses, sprays, lotions, serums, dressings, emollients, nourishers, oils, and non-medicated repair treatments; Baby toiletries, namely, baby oil; baby powder; personal body wash; skin lotion; hair shampoos and conditioners; and hair detanglers; baby cologne; cotton swabs for personal use; pre-moistened wash cloths; Non-medicated mouthwash; non-medicated oral care dissolving strips; non-medicated breath freshening dissolving strips; non-medicated breath fresheners; toothpaste.), 5(Adhesive bandages; Wound dressings, namely, adhesive bandages, gauze pads, gauze sponges, medical adhesive tape, wraps, and dressings for skin wounds; first aid kits; Antibiotics for use in the treatment of burns, general and local bacterial and virus infections; Topical antiseptic spray for infection protection and pain relief; Medicated lip care preparations; Antiseptic and antibacterial preparations for wound care; medical cleansers for healing wounds; hand sanitizing and disinfectant preparations; Medicated skin care preparations for the treatment of acne; Pharmaceutical formulations for the treatment of integumentary conditions, namely, creams, lotions, gels, solutions for care of the skin; Medicated skincare preparations, namely, creams, lotions, gels, toners, cleansers, moisturizers, peels, oils, and toners; medicated sun care preparations, namely, sun block, sun care preparations, and sun screen; medicated skincare preparations for the treatment of eczema; medicated anti-aging skincare preparations; Medicated diaper rash cream; Vitamins; vitamin drops; gummy vitamins; throat lozenges; preparations for the relief of throat pam; cough syrup; cough treatment preparations; dietary and nutritional supplements; dietary supplements for immune support; natural sleep aid preparations; gripe water preparations for treatment of intestinal gas and stomach discomfort in infants; sinus congestion treatment preparations; dietary supplement for promoting digestion; probiotic supplements; nasal spray preparation; Pharmaceutical preparations for the relief and prevention of upper

KENVUE

respiratory symptoms; nasal decongestant; Medicated bath treatment preparation to soothe and relieve irritated, itching, inflamed skin; Vapor bath products for use in the treatment of colds; Analgesics; Antihistamines; Allergy treatment preparations; Decongestants; sinus congestion treatment preparations; Topical analgesics; anti-itch gels and creams; Medicated mouthwash; Ophthalmic preparations; eye drops; Pharmaceutical anti-diarrheal preparations; Pharmaceutical preparations, namely, an acid reducer and antacid, treatment of gastrointestinal disorders; Pharmaceutical preparations, namely, smoking cessation preparations; pharmaceutical devices, namely, mouth sprays for use in connection with smoking cessation; Medicated hair regrowth preparations.), 9(Providing on-line downloadable and electronic downloadable publications, namely, newsletters, brochures, pamphlets, and flyers relating to health, beauty, skin care, oral health, sun care; computer application software for mobile phones, namely, software to assist in tracking allergy information and controlling allergy symptoms; virtual assistant in the nature of a downloadable mobile chatbot software application for simulating conversations in the field of beauty, beauty products, and beauty product recommendations; downloadable mobile applications that enable users of a cosmetic medical device to receive education and training about use of the device, chatbot software for simulating conversations in the field of beauty, beauty products, and beauty product recommendations; downloadable computer chatbot software for simulating conversations leveraging artificial intelligence in the field of beauty, beauty products, and beauty product recommendations; downloadable mobile application to provide guidance concerning use of an otoscope for performing basic self-diagnostic tests and examination, to transmit the results of such tests and examinations to a healthcare provider, and to allow communication between the user and the health care provider; virtual consumer health products; downloadable multimedia files containing artwork, text, audio, and video files and non-fungible tokens featuring consumer health products; downloadable loyalty cards, incentive cards, reward cards that may be redeemed for or used towards the purchase of consumer health products.), 10(Medical device and apparatus for the cosmetic and medical treatment of skin conditions; Adhesive compression wrap bandages for medical purposes; Heat or cold releasing packs for therapeutic purposes; Heat releasing wraps for therapeutic purposes; medical apparatus, namely, a smartphone enabled otoscope that allows a patient to perform basic self-diagnostic tests and examinations, and for transmitting the results of such tests and examinations to a healthcare provider and allowing communication between the user and the healthcare provider; photo therapeutic light delivery apparatus for medical purposes.), 21(Dental floss, dental flossers, refills for dental flossers; toothbrushes.), 35(Providing consumer product information relating to skin and hair care, sun care, wellness, healthcare and healthy living, fitness, nutrition and lifestyle wellness; Online retail store services featuring skin and hair care, sun care, dental, cough, cold, allergy, nutritional products, cosmetics; online retail services featuring virtual consumer health goods and the physical delivery of same.), 41(Educational services, namely, conducting on-line programs in the fields of beauty, health care, hair care, pregnancy, baby care, and printable educational materials about skin and health care distributed therewith; Providing non-downloadable educational materials in the nature of articles and brochures in the field of beauty and health care; Providing on-line non-downloadable publications in the nature of articles, newsletters, and blogs relating to beauty and health care; entertainment services, namely, providing online, downloadable, virtual consumer health care products for use in

virtual environments for entertainment purposes.), 42(Product research and development in the field of beauty, wellness, hair care, allergies, child care, baby care, and health care products.) and 44(Providing information in the field of consumer products, beauty, hair care, health care, wellness, allergies, nutrition, pregnancy, baby care, and child care; providing a website featuring information on healthcare and healthy living.) (526): None (730): JOHNSON & JOHNSON, a corporation organized and existing under the laws of the State of New Jersey, U.S.A. of One Johnson & Johnson Plaza, New Brunswick, New Jersey, 08933, United States of America (740): CFL Advocates of P.O. Box 23555 - 00100, Nairobi, Kenya

(210): 124296 (220): 29/09/2022

(300): None (511): 16(Paper; cardboard; printed matter; printed publications; newsletters; magazines; brochures; travel brochures; stationery; pens; pencils; stickers; postcards; business cards; notebooks; diaries; calendars; parts, fittings and accessories for the aforesaid goods.), 25(Clothing.) and 35(Advertising, promotion and marketing services.) (526): Registration of this mark shall give no right to the exclusive use of the letter "P" separately and apart from the mark as a whole. (730): HOTPOINT APPLIANCES LIMITED of Sukari Industrial Estate off Thika Superhighway Exit 10 behind Kenya Clay Works, P.O. Box 402 - 00606, Nairobi, Kenya (740): Coulson Harney Advocates of P.O. Box 10643 - 00100, Nairobi, Kenya



(210): 124320 (220): 30/09/2022

(300): None (511): 2(Shoe dye) (526): Registration of this mark shall give no right to the exclusive use of the words 'STRONG', 'BLACK', 'LEATHER', 'DYE' and the device of a 'pair of shoes' each separately and apart from the mark as a whole. (730): MARGARET MITHIRI ORANGO of P.O. Box 27960 - 00100, Nairobi, Kenya (740): None



BLACK LEATHER DYE

(210): 124325 (220): 30/09/2022

(300): None (511): 32(Purified drinking water.) (526): Registration of this mark shall give no right to the exclusive use of the word 'MIST' and the device of the 'MOUNTAIN', 'WATER' and 'VEGETATIONS' each separately and apart from the mark as a whole. (730): MWAROMO LIMITED of P.O. Box 8319 - 00500, Nairobi, Kenya (740): None



Virmist

(210): 124349 (220): 03/10/2022

(300): None (511): 9(Circuit breaker; Miniature Circuit Breaker, Residual Current Circuit Breaker, Residual Current Circuit Breaker with overcurrent protection, Surge Protection Devices; Switches; Switch Disconnecter.) (526): Registration of this mark shall give no right to the exclusive use of the numeral "9" separately and apart from the mark as a whole. (730): SCHNEIDER ELECTRIC INDUSTRIES SAS Société par Actions Simplifiée France of 35 rue Joseph Monier F-92500 RUEIL-MALMAISON, France (740): Hamilton Harrison & Mathews Advocates of P.O. Box 30333 - 00100, Nairobi, Kenya

GO9

(210): 124453 (220): 07/10/2022

(300): None (511): 31(Animal feeds.) (526): Registration of this mark shall give no right to the exclusive use of the word "FEEDS" separately and apart from the mark as a whole. (730): SWEET CORN MAIZE MILLER'S LIMITED of P.O. Box 655 - 00232, Ruiru, Kenya (740): None

KINGDOM FEEDS

(210): 124458 (220): 07/10/2022

(300): None (511): 30(Coffee, tea, cocoa and artificial coffee; rice; tapioca and sago; flour and preparations made from cereals; bread, pastries and confectionery; edible ices; sugar, honey, treacle; yeast, baking-powder; salt; mustard; vinegar, sauces (condiments); spices; ice (frozen water) (526): None (730): ABED ANASER FATHI SAAED ELDEN of Trading Center, Nablus, Palestine (740): Gikera & Vadgama Advocates of P.O. Box 720 - 00621, Nairobi, Kenya



(210): 124459 (220): 07/10/2022

(300): None (511): 30(Coffee, tea, cocoa and artificial coffee; rice; tapioca and sago; flour and preparations made from cereals; bread, pastries and confectionery; edible ices; sugar, honey, treacle; yeast, baking-powder; salt; mustard; vinegar, sauces (condiments); spices; ice (frozen water) (526): Transliteration of the Arabic character is "The Tiger" (730): ABED ANASER FATHI SAAED ELDEN of Trading Center, Nablus, Palestine (740): Gikera & Vadgama Advocates of P.O. Box 720 - 00621, Nairobi, Kenya



(210): 124460 (220): 07/10/2022

(300): None (511): 30(Coffee, tea, cocoa and artificial coffee; rice; tapioca and sago; flour and preparations made from cereals; bread, pastries and confectionery; edible ices; sugar, honey, treacle; yeast, baking-powder; salt; mustard; vinegar, sauces (condiments); spices; ice (frozen water) (526): Transliteration of the Arabic character is 'Saaedelden' which is a combination of two of the proprietor's names - Saaed and Elden (730): ABED ANASER FATHI SAAED ELDEN of Trading Center, Nablus, Palestine (740): Gikera & Vadgama Advocates of P.O. Box 720 - 00621, Nairobi, Kenya

سعد الدين

(210): 124472 (220): 07/10/2022

(300): None (511): 33(Alcoholic beverages, except beers; Alcoholic preparations for making beverages; Wine) (526): None (730): TRUSTEES FOR THE TIME BEING OF THE CHARLES BACK TRADEMARK TRUST of Fairview, Agter Paarl, Paarl, Western Cape, South Africa (740): Coulson Harney Advocates of P.O. Box 10643 - 00100, Nairobi, Kenya

GOATS DO ROAM

(210): 124496 (220): 11/10/2022

(300): None (511): 9(Phone & Accessories.) (526): None (730): LITEL TELECOMMUNICATION COMPANY LTD of P.O. Box 45689 - 00100, Nairobi, Kenya (740): None

LUXUS

(210): 124515 (220): 12/10/2022

(300): None (511): 43(Services for providing food and drink) (526): Registration of this mark shall give no right to the exclusive use of the word 'FEEDING' separately and apart from the mark as a whole. (730): FOOD FOR EDUCATION FOUNDATION of 5th Floor, The Address, Waiyaki Way, P. O. Box 65737 - 00607, Kamiti, Kenya (740): IC Law Advocates LLP of P.O. Box 12295 - 00100, Nairobi, Kenya

FEEDING THE FUTURE

(210): 124526 (220): 13/10/2022

(300): None (511): 41(Provision of entertainment services) (526): Registration of this mark shall give no right to the exclusive use of the word 'milan' separately and apart from the mark as a whole. (730): MILAN CONCEPTS LIMITED of P. O. Box 959 - 00618, Nairobi, Kenya (740): None



(210): 124550 (220): 14/10/2022

(300): None (511): 5(Preparations for destroying vermin, herbicides and fungicides) (526): Registration of this mark shall give no right to the exclusive use of the word 'IDAHO' and 'Leaf' device each separately and apart from the mark as a whole. 'IDAHO' is a Northwestern U.S State (730): SINERIA KENYA LIMITED of P. O. Box 79777 - 00200, Nairobi, Kenya (740): None

IDAHO

(210): 124577 **(220):** 18/10/2022

(300): None **(511):** 9(Security tokens (encryption devices); electronic publications, downloadable; electronic interactive whiteboards; computer programs (downloadable software); interactive touch screen terminals; computer software applications, downloadable; downloadable applications for use with mobile devices; downloadable image files; computer software platforms, recorded or downloadable; computer programs, recorded; computer software; software and applications for use with mobile devices; computer software platforms; application software; software for providing online trading platform for digital assets; computer programs and computer software for electronic trading of securities; computer programs for use in trading stocks and bonds; machine learning software for finance; computer software related to financial information, investment, and trading, namely, electronic trading software and investment portfolio management software; software for providing electronic connectivity to financial exchanges and markets; computer programs for electronic trading of virtual currency; computer software for electronic trading of virtual currency; and software for providing online trading platform for financial products.) and 36(Insurance brokerage; stocks and bonds brokerage; stock exchange information services; providing stock market information; financial management; financial investment analysis and stock research; futures exchange services; providing securities market information; investment risk assessment services; securities trading services; stock trading; financial guarantees (surety services); trusteeship; trading in equities; cryptocurrency trading services; stock exchange services; electronic stock exchange services; foreign currency exchange; commodity trading; securities exchange services; financial transactions; options trading; financial portfolio management; securities brokerage; completion of financial transactions for stocks, bonds, securities and equities for others; financial and investment market risk analysis, appraisal and projection; financial management and investment services relating to securities and equities; preparation and quotation of stock exchange prices and indices; financial advisory services relating to securities, derivatives and other financial products; trading of financial instruments, securities, shares, options and other derivative products; and providing information and research in the field of finance and financial investments.) **(526):** Registration of this mark shall give no right to the exclusive use of the word "TRADE" separately and apart from the mark as a whole. **(730):** TIGER FINTECH (SINGAPORE) PTE LTD of 1 Raffles Place, #35-61 One Raffles Place (048616), Singapore **(740):** Ndikimi & Company Advocates of P.O. Box 29037 - 00625, Nairobi, Kenya

(210): 124583 **(220):** 18/10/2022

(300): None **(511):** 34(Cigarettes; tobacco, raw or manufactured; tobacco products; tobacco substitutes (not for medical purposes); cigars; cigarillos; lighters for smokers; matches; smokers' articles; cigarette paper; cigarette tubes; cigarette filters; pocket apparatus for rolling cigarettes; hand held machines for injecting tobacco into paper tubes; electronic cigarettes; cartridges for electronic cigarettes; liquids for electronic cigarettes; tobacco products for the purpose of being heated; devices and parts for devices for heating tobacco; tobacco substitutes for the purpose of inhalation; cigarettes containing tobacco substitutes; cigarette cases; cigarette boxes; snus with tobacco; snuff with tobacco; snus without tobacco; snuff without tobacco; tobacco free oral nicotine pouches (not for medical use). **(526):** None **(730):** NICOVENTURES HOLDINGS LIMITED of Globe House, 1 Water Street London WC2R 3LA, United Kingdom **(740):** Iseme, Kamau & Maema Advocates of P.O. Box 11866 - 00400, Nairobi, Kenya



Tiger Trade

VUSE GO

(210): 124627 (220): 21/10/2022

(300): None (511): 9(Computer hardware and downloadable software for facilitating and administering payment transactions, banking transactions, and payment card services; computer hardware and downloadable software for electronic processing and transmission of bill payment data; computer hardware and downloadable software for cash disbursement services, automatic teller machine services, transaction authentication, routing, authorization and settlement services, fraud detection and control, disaster recovery and encryption services; telecommunication and electrical apparatus and instruments, namely, apparatus for the recording, transmission and reproduction of data including sound and images; accounting machines; apparatus for tracking, management and analysis of financial accounts via a global computer network; computer hardware and downloadable software, namely, for the development, maintenance and use of local and wide area computer networks; systems for reading memory cards and systems for reading data in memories, namely, integrated circuit memories and banking card memories; downloadable electronic publications; printing apparatus for data processing systems and financial transaction systems; encoders and decoders; modems; computer hardware and downloadable software for facilitating payment transactions by electronic means over wireless networks, global computer networks and/or mobile telecommunications devices; computer hardware and downloadable software for the creation of encryption keys, digital certificates, and digital signatures; downloadable computer software for secure data storage and retrieval and transmission of confidential customer information used by individuals, banking and financial institutions; computer hardware and downloadable software that facilitates the identification and authentication of near field communication (NFC) devices and radio frequency identification (RFID) devices; downloadable computer software comprising a digital wallet to access coupons, vouchers, voucher codes and rebates at retailers and to obtain loyalty or monetary rewards; downloadable computer software comprising a digital wallet that allow users to access price-comparison information, product reviews, links to the retail websites of others, and discount information; software application for use in connection with contactless payment terminals for the purpose of allowing merchants to accept contactless mobile commerce transactions, contactless presentation of loyalty credentials, and contactless redemption of coupons, rebates, discounts, vouchers and special offers; downloadable computer software for managing and verifying cryptocurrency transactions using blockchain technology; downloadable computer software for generating cryptographic keys for receiving and spending cryptocurrency; downloadable computer software for use as a cryptocurrency wallet; downloadable computer software for blockchain-based inventory and supply-chain management; downloadable computer software for accessing, reading, and tracking information in the field of financial transactions on a blockchain; integrated circuit chips for use in mobile phones and NFC and RFID devices; magnetic encoded cards and cards containing an integrated circuit chip ("smart cards"); security encoded cards; hologram impregnated cards (encoded); charge cards, bank cards, credit cards, debit cards, chip cards, installment cards, stored value cards, electronic data carrier cards, payment cards; banking cards, namely, magnetically encoded banking cards and banking cards using magnetic memories and integrated circuit memories; payment card readers; magnetic coded card readers, electronic data carrier card readers, electronic encryption units; computer hardware and downloadable software for use in the financial services, banking and telecommunications industries; downloadable computer software



designed to enable smart cards to interact with terminals and readers; computer chips embedded in telephones and other communication devices; telecommunications equipment; point of sale transaction terminals and computer software for transmitting, displaying and storing transaction, identification and financial information for use in the financial services, banking and telecommunications industries; radio frequency identification devices (transponders); electronic verification apparatus for verifying authentication of charge cards, bank cards, credit cards, debit cards and payment cards; cash dispensing machines; parts and fittings for all the aforesaid goods.), 35(Business advisory services; business investigations; commercial information agencies; presentation of goods on communication media for retail purposes; price comparison services; organization of exhibitions for commercial or advertising purposes; marketing consulting services; market research services; tracking, analyzing, forecasting and reporting cardholder purchase behavior; promoting the sale of the goods and services of others by means of rewards and incentives generated in connection with the use of credit, debit and payment cards; business administration of loyalty and rewards programs; commercial, industrial and business management assistance; business appraisals; advisory services for business management; preparation of statements of accounts; book-keeping; business research; public relations; retail services provided online or through mobile telecommunications means in connection with the provision of credit, debit, and payment cards; computer database management; compiling indexes of information using blockchain technology; promoting concerts and cultural events of others; advertising for transport, travel, hotels, lodging, food and meals, sports, entertainment and sightseeing; providing information regarding purchase of goods and services on-line via the Internet and other computer networks; financial records management; information, advisory and consultancy services related to all the aforesaid services.) and 36(Financial consultancy; financial information; financial sponsorship; financial services, namely, banking services, credit card services, debit card services, charge card services, installment card services, pre-paid card services offered through cards with stored value, electronic credit and debit transactions, bill payment and presentment services, cash disbursement, check verification, check cashing, deposit access and automated teller machine services, transaction authorization and settlement services, transaction reconciliation, cash management, consolidated funds settlement, consolidated dispute processing, funds movement services in the field of payment cards, electronic payment processing services, payment transaction authentication and verification services; electronic funds transfer and currency exchange services; cryptocurrency payment processing services; cryptocurrency exchange services featuring blockchain technology; providing financial information in the field of cryptocurrency; financial assessment and risk management services for others in the field of consumer credit; dissemination of financial information via a global computer network; financial analysis and consultation; processing services for financial transactions by card holders via automatic teller machines; maintenance of financial records; stored value electronic purse services; electronic banking via a global computer network; financial clearing house services; real estate property services; real estate valuations; real estate investment management; real estate investment services; real estate insurance services; real estate financing; real estate brokerage; real estate appraisals; real estate agency services; evaluation of real estate; real estate administration; administration of financial affairs relating to real estate; provision of real estate loans; financing services

relating to real estate development; financial brokerage services for real estate; capital investment in real estate; commercial property investment services; financial services relating to the acquisition of property; financial services relating to the sale of property; leasing of real estate property; estate management services relating to transactions in real property; valuation of property; property portfolio management; mortgage financing and asset securitization; consulting services regarding payment solutions, banking, credit cards, debit cards and payment cards; information, advisory and consultancy services relating to all the aforesaid services) (526): None (730): MASTERCARD INTERNATIONAL INC of 2000 Purchase Street, Purchase, New York 10577, United States of America (740): Kaplan & Stratton Advocates of P.O. Box 40111 - 00100, Nairobi, Kenya

(210): 124663 (220): 24/10/2022

(300): None (511): 18(Leather and imitations of leather, and goods made of these materials and not included in other classes; Animal skins, hides; Trunks and travelling bags; Umbrellas and parasols; Walking sticks; Whips, harness and saddlery.) (526): None (730): KORNA HARDWARE AND SUPPLIES LIMITED of P.O. Box 1168 - 00606, Nairobi, Kenya (740): None

SIMBALAND

(210): 124664 (220): 24/10/2022

(300): None (511): 25(Clothing, footwear, headgear.) (526): None (730): KORNA HARDWARE & SUPPLIES LTD of P.O. Box 1168 - 00606, Nairobi, Kenya (740): None

KINGSIMBA

(210): 124665 (220): 24/10/2022

(300): None (511): 25(Clothing, footwear, headgear.) (526): Registration of this mark shall give no right to the exclusive use of the device of the "CROWN" separately and apart from the mark as a whole. (730): KORNA HARDWARE AND SUPPLIES LIMITED of P.O. Box 1168 - 00606, Nairobi, Kenya (740): None



(210): 124667 (220): 24/10/2022

(300): None (511): 5(Baby diapers, baby wipes, sanitary pads, napkins; liners and adult diapers.) (526): Registration of this mark shall give no right to the exclusive use of the words "Soft", "Comfortable", "Skin", "Dry", "Clean", "Healthy", "Baby" and the devices of the "heart", "mother" and "baby" each separately and apart from the mark as a whole. (730): KORNA HARDWARE & SUPPLIES LTD of P.O. Box 1168 - 00606, Nairobi, Kenya (740): None



(210): 124668 (220): 24/10/2022

(300): None (511): 16(Tissue paper; Serviettes.) (526): None 'PIAOPIAOPIAO' is Chinese phrase meaning "Snow Flakes Float" in English (730): KORNA HARDWARE AND SUPPLIES LIMITED of P.O. Box 1168 - 00606, Nairobi, Kenya (740): None

PIAOPIAOPIAO

(210): 124670 (220): 24/10/2022

(300): None (511): 16(Tissue paper; serviettes.) (526): None 'PIAOPIAO' is a Chinese phrase meaning "Snow Flakes Float" in English (730): KORNA HARDWARE AND SUPPLIES LIMITED of P.O. Box 1168 - 00606, Nairobi, Kenya (740): None

PIAOPIAO

(210): 124670 (220): 24/10/2022

(300): None (511): 5(Baby diapers, baby wipes, sanitary pads, napkins; liners and adult diapers.) (526): 'PIAOPIAO' is a Chinese phrase meaning "Snow Flakes Float" in English (730): KORNA HARDWARE & SUPPLIES LTD of P.O. Box 1168 - 00606, Kenya (740): None

PIAOPIAO

(210): 124671 (220): 24/10/2022

(300): None (511): 30(Coffee, tea cocoa, rice, flour & preparation made from cereals, bread, pastry & confectionery, sugar, honey, yeast, baking powder, salt, mustered, vinegar, services, spices.) (526): None (730): ZAHID ABBAS of P.O. Box 83173 - 80100, Mombasa, Kenya (740): None



(210): 124677 (220): 24/10/2022

(300): None (511): 30(Chocolates, confectionery, candies, biscuits (all types), cakes, pasta, macaroni, noodles, instant noodles, spaghetti, vermicelli, yeast, baking powder and other bakery ingredients, salad dressings, mayonnaise, vinegar, ketchup and sauces (condiments), ready to cook dough products, frozen dough, frozen parathas, ice creams, non-dairy frozen desserts, frozen fruit desserts, ice desserts, coffee, tea, cocoa, sugar, rice, tapioca, sago, artificial coffee, bread, pastry, treacle, salt, mustard, flour made from cereals, spices, food beverages (grain-based and herbal), gravies, herbal tea, honey, popcorn.) (526): None (730): INTERNATIONAL FOODSTUFFS CO. L. L. C. of Al-Wahda Street, Industrial Area No. 1, P.O. Box 4115, Sharjah, United Arab Emirates (740): Talal Abu-Ghazaleh Intellectual Property of P. O. Box 20140 - 00100, Nairobi, Kenya

BUTTERMOMO
بترمومو

(210): 124685 (220): 25/10/2022

(300): None (511): 41(Sporting activities.) (526): Registration of this mark shall give no right to the exclusive use of the words "KAKAMEGA", "MARATHON" and the device of "human beings" and "tree" each separately and apart from the mark as a whole. (730): KAKAMEGA FOREST MARATHON of P.O. Box 54071 - 00200, Nairobi, Kenya (740): Felix Mindikira Mindikira & Company Advocates of P.O. Box 30469 - 00100, Nairobi, Kenya



(210): 124699 (220): 25/10/2022

(300): None (511): 5(Disinfectant for use on pre-cleaned surfaces.) (526): None (730): DIVERSEY, INC. of 1300 Altura Road, Suite 125, Fort Mill, South Carolina 29708, United States of America (740): Ndungu Njoroge & Kwach Advocates of P.O. Box 41546 - 00100, Nairobi, Kenya

ENDBAC

(210): 124751 (220): 27/10/2022

(300): None (511): 9(Batteries for vehicles, batteries for lighting, electric batteries, battery chargers, batteries for aircraft and boats and for industrial uses, for use in alternative power sources as well as batteries for electronic equipment and related solar products and solar panels.) (526): None (730): ASSOCIATED BATTERY MANUFACTURES (EAST AFRICA) LIMITED of P.O. Box 48917 - 00100, Nairobi, Kenya (740): Kaplan & Stratton Advocates of P.O. Box 40111-00100, Nairobi, Kenya

SPARTAN

(210): 124757 (220): 27/10/2022

(300): None (511): 32(Beers; Mineral and aerated waters and other non-alcoholic drinks; Fruit drinks and fruit juices; Syrups and other preparations for making beverages.) (526): Registration of this mark shall give no right to the exclusive use of the words "ENERGY", "DRINK", "INSTANT", "BOOST" and the device of a "CHEETAH" each separately and apart from the mark as a whole (730): AQUAMIST LIMITED of P.O. Box 66856 - 00800, Nairobi, Kenya (740): O & M Law LLP of P.O. Box 49393 - 00100, Nairobi, Kenya

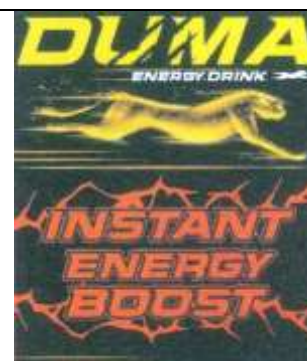

\(210): 124758 (220): 27/10/2022

(300): None (511): 32(Beers; Mineral and aerated waters and other non-alcoholic drinks; Fruit drinks and fruit juices; Syrups and other preparations for making beverages.) (526): None (730): AQUAMIST LIMITED of P.O. Box 66856 - 00800, Nairobi, Kenya (740): O & M Law LLP of P.O. Box 49393 - 00100, Nairobi, Kenya

ALKAMIST

(210): 124834 (220): 01/11/2022

(300): None (511): 16(Information book about divorce and failed relationships, ways to nourish your heart to find love again and to shed light on the legal process of divorce and child support in Kenya) (526): None (730): CHRISTINE MAINA of P. O. Box 52046 - 30100, Nairobi, Kenya (740): None



(210): 124855 (220): 02/11/2022

(300): None (511): 36(Insurance, financial affairs, monetary affairs, real estate affairs.) (526): None (730): FOURTH GENERATION CAPITAL LIMITED of Africa Reit House, Africa Reit Lane, P.O. Box 4916 - 00100, Nairobi, Kenya (740): None

HEROES OF THE HUSTLE

(210): 124858 (220): 02/11/2022

(300): None (511): 5(Pharmaceuticals and medical preparations; sanitary preparations for medical purposes; dietetic food and substances adapted for medical or veterinary use, food for babies; dietary supplements for humans and animals; plasters, materials for dressings; material for stopping teeth, dental wax; disinfectants) (526): Registration of this mark shall give no right to the exclusive use of the suffix "WELL" separately and apart from the mark as a whole. (730): ABHIJEET HODA of 1305, I Block Mantri Synergy Apartments, 1/124 Rajiv Gandhi Salai, Padur, Chennai (Tamil Nadu), India - 603103 (740): Kabau & Associates Advocates of P. O. Box 101136 - 00101, Nairobi, Kenya

SEMAWELL

(210): 124860 (220): 03/11/2022

(300): None (511): 9(Scientific, nautical, surveying, photographic, cinematographic, optical, weighing, measuring, signaling, checking (supervision), life-saving and teaching apparatus and instruments; apparatus and instruments for conducting, switching, transforming, accumulating, regulating or controlling electricity; apparatus for recording, transmission or reproduction of sound or images; magnetic data carriers, recording discs; compact discs, DVDs and other digital recording media; mechanisms for coin-operated apparatus; cash registers, calculating machines, data processing equipment, computers; computer software; fire-extinguishing apparatus), 13(Firearms; Ammunition and projectiles; Explosives; Fireworks.), 41(Education; Providing of training; Entertainment; Sporting and cultural activities) and 42(Scientific and technological services and research and design relating thereto; industrial analysis and research services; design and development of computer hardware and software.) (526): None (730): RAVENSWOOD SOLUTIONS, INC of 48371 Fremontblvd, Suite 105, Fremont, CA 94538, United States of America (740): Emsi & Associates of P.O. Box 1791 - 00606, Nairobi, Kenya



(210): 124865 (220): 03/11/2022

(300): None (511): 16(Plastic and Paper packaging solutions; Packages and packaging material made of paper or made of paper coated with plastic laminate or made of foamed plastics; Packaging containers of cardboard paper or plastic for food and drink products; Storage boxes made of paper or plastic; Packing boxes made of plastic and cardboard paper; Containers of plastic and paper packaging; Packages, including packages made of paper, cardboard, plastics, foamed plastics, or combinations of these materials;

SMARTPAK

packaging materials of paper, cardboard, plastics, foamed plastics, or combinations of these materials.) (526): None (730): TECHPAK INDUSTRIES LIMITED of Road A (Off Enterprise Road) Industrial Area, P.O. Box 30802 - 00100, Nairobi, Kenya (740): Muthoni Advocates of P.O. Box 28397 - 00200, Nairobi, Kenya

(210): 124866 (220): 03/11/2022

(300): None (511): 16(Plastic and Paper packaging solutions; Packages and packaging material made of paper or made of paper coated with plastic laminate or made of foamed plastics; Packaging containers of cardboard paper or plastic for food and drink products; Storage boxes made of paper or plastic; Packing boxes made of plastic and cardboard paper; Containers of plastic and paper packaging; Packages, including packages made of paper, cardboard, plastics, foamed plastics, or combinations of these materials; packaging materials of paper, cardboard, plastics, foamed plastics, or combinations of these materials.) (526): None (730): TECHPAK INDUSTRIES LIMITED of Road A (Off Enterprise Road) Industrial Area, P.O. Box 30802 - 00100, Nairobi, Kenya (740): Muthoni Advocates of P.O. Box 28397 - 00200, Nairobi, Kenya



(210): 124903 (220): 04/11/2022

(300): None (511): 30(Flour and preparations made from cereals) (526): Registration of this mark shall give no right to the exclusive use of the words 'Taste', 'Life', 'Goodness', 'Lapizuri' device of a 'calabash and its content' each separately and apart from the mark as a whole. "Lapizuri" means 'precious foundations' in English. (730): LAPIZURI INDUSTRIES LIMITED of P.O. Box 76156 - 00508, Nairobi, Kenya (740): None



(210): 124904 (220): 04/11/2022

(300): None (511): 32(Beers, mineral and aerated waters and other non-alcoholic beverages, fruit beverages and fruit juices; Syrups and other preparations for making beverages.) and 33(Alcoholic beverages (Except beers) (526): None (730): PRIMAVERA FARMS LTD of APT 906, Dhanjay Apts, Valley Arcade, P.O. Box 2369 - 00606, Nairobi, Kenya (740): None

WILDEBEST

(210): 124905 (220): 04/11/2022

(300): None (511): 43(Services for providing food and drink; Temporary accommodation) (526): None (730): PRIMAVERA FARMS LTD of APT 906, Dhanjay Apts, Valley Arcade, P.O. Box 2369 - 00606, Nairobi, Kenya (740): None

THE RICKHOUSE

(210): 124906 (220): 04/11/2022

(300): None (511): 43(Services for providing food and drink; Temporary accommodation) (526): None (730): PRIMAVERA FARMS LTD of APT 906, Dhanjay Apts, Valley Arcade, P.O. Box 2369 - 00606, Nairobi, Kenya (740): None

BARLEY AND JUNIPER

(210): 124907 (220): 04/11/2022

(300): None (511): 33(Alcoholic beverages (Except beers) (526): None (730): PRIMAVERA FARMS LTD of APT 906, Dhanjay Apts, Valley Arcade, P.O. Box 2369 - 00606, Nairobi, Kenya (740): None

TURTLE BAY

(210): 124909 (220): 04/11/2022

(300): None (511): 7(Industrial robots; hydraulic turbines; stone-working machines; shredders (machines) for industrial use; drilling machines; pumps (machines); electric welding apparatus; electric hammers; jacks machines; and lawnmowers machines.) (526): None (730): WENLING AWT MACHINERY CO., LTD. of East of Xincheng Avenue, Qiaowu Village, Zeguo Town, Wenling, Taizhou City, Zhejiang Province, China (740): Ndikimi & Company Advocates of P.O. Box 29037 - 00625, Nairobi, Kenya

AWTECNO

(210): 124962 (220): 08/11/2022

(300): None (511): 30(Rice.) (526): Registration of this mark shall give no right to the exclusive use of the word "GOLD" separately and apart from the mark as a whole. "AMAR" is a Hindu word that means "Forever" in English. (730): VARUN DISTRIBUTORS LIMITED of P.O. 97170 - 80100, Mombasa, Kenya (740): None



(210): 124963 (220): 08/11/2022

(300): None (511): 30(Rice.) (526): Registration of this mark shall give no right to the exclusive use of the word "LEADER" separately and apart from the mark as a whole. (730): VARUN DISTRIBUTORS LIMITED of P.O. Box 97170 - 80100, Mombasa, Kenya (740): None



(210): 124968 (220): 08/11/2022

(300): None (511): 5(Pharmaceuticals, medical and veterinary preparations; sanitary preparations for medical purposes; dietetic food and substances adapted for medical or veterinary use, food for babies; dietary supplements for humans and animals.) (526): None (730): INVENTIA HEALTHCARE LIMITED of Unit 703 - 704, 7th Floor, Hubtown Solaris, N.S. Phadke Marg, Andheri (East) Mumbai - 400069, India (740): Muthoni Advocates of P. O. Box 28397 - 00200, Nairobi, Kenya

ACHAID

(210): 124970 (220): 08/11/2022

(300): None (511): 5(Pharmaceuticals, medical and veterinary preparations; sanitary preparations for medical purposes; dietetic food and substances adapted for medical or veterinary use, food for babies; dietary supplements for humans and animals.) (526): None (730): INVENTIA HEALTHCARE LIMITED of Unit 703 - 704, 7th Floor, Hubtown Solaris, N.S. Phadke Marg, Andheri (East) Mumbai - 400069, India (740): Muthoni Advocates of P. O. Box 28397 - 00200, Nairobi, Kenya

ESOMEZOL

(210): 124971 (220): 08/11/2022

(300): None (511): 5(Pharmaceuticals, medical and veterinary preparations; sanitary preparations for medical purposes; dietetic food and substances adapted for medical or veterinary use, food for babies; dietary supplements for humans and animals.) (526): None (730): INVENTIA HEALTHCARE LIMITED of Unit 703 - 704, 7th Floor, Hubtown Solaris, N.S. Phadke Marg, Andheri (East) Mumbai - 400069, India (740): Muthoni Advocates of P. O. Box 28397 - 00200, Nairobi, Kenya

PROGLUTROL

(210): 124972 (220): 08/11/2022

(300): None (511): 5(Pharmaceuticals, medical and veterinary preparations; sanitary preparations for medical purposes; dietetic food and substances adapted for medical or veterinary use, food for babies; dietary supplements for humans and animals.) (526): None (730): INVENTIA HEALTHCARE LIMITED of Unit 703 - 704, 7th Floor, Hubtown Solaris, N.S. Phadke Marg, Andheri (East) Mumbai - 400069, India (740): Muthoni Advocates of P. O. Box 28397 - 00200, Nairobi, Kenya

NOTHROMBI

(210): 124974 (220): 08/11/2022

(300): None (511): 5(Pharmaceuticals, medical and veterinary preparations; sanitary preparations for medical purposes; dietetic food and substances adapted for medical or veterinary use, food for babies; dietary supplements for humans and animals.) (526): None (730): INVENTIA HEALTHCARE LIMITED of Unit 703 - 704, 7th Floor, Hubtown Solaris, N.S. Phadke Marg, Andheri (East) Mumbai - 400069, India (740): Muthoni Advocates of P. O. Box 28397 - 00200, Nairobi, Kenya

SEGABIN

(210): 124978 (220): 09/11/2022

(300): None (511): 36(Insurance; financial affairs; monetary affairs; real estate affairs) (526): None (730): SUNBIRD BUSINESS SERVICES KENYA LTD. of P.O. Box 856 - 00606, Nairobi, Kenya (740): None

KOFISI

(210): 125010 (220): 10/11/2022
 (300): None (511): 25(Clothing, footwear, headgear) (526): Registration of this mark shall give no right to the exclusive use of the word 'Unique' and the device of the 'human hand' each separately and apart from the mark as a whole. (730): JOWMART TRADERS LIMITED of P. O. Box 2677, Kipanda Athumani Street, Olympic Shopping Mall, Eastleigh, Nairobi, Kenya (740): None



(210): 125012 (220): 10/11/2022
 (300): None (511): 3(Cosmetics.) (526): Registration of this mark shall give no right to the exclusive use of the word 'ORGANICS' and the letters 'K' and 'J' each separately and apart from the mark as a whole. (730): KADHARA JAMA of P.O. Box 42348 - 008100, Nairobi, Kenya (740): None



(210): 125020 (220): 10/11/2022
 (300): None (511): 5(Pharmaceuticals) (526): None (730): CROWN SOLUTIONS LIMITED of P.O. Box 40499 - 00100, Nairobi, Kenya (740): None

CLARON

(210): 125021 (220): 10/11/2022
 (300): None (511): 5(Pharmaceuticals) (526): Registration of this mark shall give no right to the exclusive use of the word "CURE" separately and apart from the mark as a whole. (730): CROWN SOLUTIONS LIMITED of P.O. Box 40499 - 00100, Nairobi, Kenya (740): None

HELI-CURE

(210): 125022 (220): 10/11/2022
 (300): None (511): 5(Pharmaceuticals) (526): Registration of this mark shall give no right to the exclusive use of the word "CARE" separately and apart from the mark as a whole. (730): CROWN SOLUTIONS LIMITED of P.O. Box 40499 - 00100, Nairobi, Kenya (740): None

GYNO-CARE

(210): 125023 (220): 10/11/2022
 (300): None (511): 5(Pharmaceuticals) (526): Registration of this mark shall give no right to the exclusive use of the letter "C" separately and apart from the mark as a whole. (730): CROWN SOLUTIONS LIMITED of P.O. Box 40499 - 00100, Nairobi, Kenya (740): None

C-TINI

(210): 125024 (220): 10/11/2022
 (300): None (511): 5(Pharmaceuticals) (526): None (730): CROWN SOLUTIONS LIMITED of P. O. Box 40499 - 00100, Nairobi, Kenya (740): None

VORMITAB

(210): 125058 (220): 11/11/2022
 (300): None (511): 21(Household and kitchen utensils and containers.) (526): None (730): KHS PRODUCTS LIMITED of P.O. Box 80360 - 80100, Mombasa, Kenya (740): Benson Waweru Thuo of P.O. Box 39632 - 00623, Nairobi, Kenya

NORI

(210): 125059 (220): 11/11/2022
 (300): None (511): 5(Pharmaceuticals, medical and veterinary preparations; sanitary preparations for medical purposes; dietetic food and substances adapted for medical or veterinary use, food for babies; dietary supplements for humans and animals; plasters, materials for dressings; material for stopping teeth, dental wax; disinfectants; preparations for destroying vermin; fungicides, herbicides.) (526): The applicant claims the colours blue and white as elements of the mark, as depicted in the attached representations. (730): TIGER FOOD BRANDS INTELLECTUAL PROPERTY HOLDING COMPANY (PROPRIETARY) LIMITED, a South African Company of 3010 William Nicol Drive, Bryanston 2191, Gauteng, South Africa (740): Ndungu Njoroge & Kwach Advocates of P.O. Box 41546 - 00100, Nairobi, Kenya



(210): 125060 (220): 11/11/2022

(300): None (511): 5(Herbicides, fungicides, pesticides.) (526): None (730): DVA Agro East Africa Ltd of Spur Mall, Along Thika Superhighway, 2nd Flr, Office No. S20, Ruiru 00232, Kenya (740): Ndungu Njoroge & Kwach of P.O. Box 41546 - 00100, Nairobi, Kenya

FUTAPEST

(210): 125069 (220): 11/11/2022

(300): None (511): 30(Chocolates, confectionery, candies, biscuits(all types), cakes, pasta, macaroni, noodles, instant noodles, spaghetti, vermicelli, yeast, baking powder and other bakery ingredients, salad dressings, mayonnaise, vinegar, ketchup and sauces (condiments), ready to cook dough products, frozen dough, frozen parathas, ice creams, non-dairy frozen desserts, frozen fruit desserts, ice desserts, coffee, tea, cocoa, sugar, rice, tapioca, sago, artificial coffee, bread, pastry, treacle, salt, mustard, flour made from cereals, spices, food beverages (grain- based and herbal), gravies, herbal tea, honey, popcorn.) (526): Registration of this mark shall give no right to the exclusive use of the word "ONE" separately and apart from the mark as a whole. The Arabic characters are a transliteration of "ONE LAST ONE" (730): INTERNATIONAL FOODSTUFFS CO. L.L.C, a United Arab Emirates Limited Liability Company of Post Box 4115, Sharjah, United Arab Emirates (740): Talal Abu-Ghazaleh Intellectual Property of P.O. Box 2537 - 00606, Nairobi, Kenya

ONE LAST ONE
ون لاست ون

(210): 125108 (220): 14/11/2022

(300): None (511): 16(Cardboard and cardboard articles, Paper and paper articles, Printed materials, Letterheads paper, Envelopes, writing pads, Stationery, Books, Pamphlets, Magazines, Advertising Matters, Cards, Posters, Wrappers (stationery) and 35(Advertising, Business Management, Business Administration, Office functions including office functions in relation to Direct Sales; bringing together, for the benefit of others, of a variety of goods, excluding the transport thereof, enabling customers to conveniently view and purchase those goods; provision of information and advisory services relating to e-commerce; wholesaling and retailing of goods (by any means) (526): Registration of this mark shall give no right to the exclusive use of the letter 'Q' and the word 'NET' each separately and apart from the mark as a whole. The Applicant claims the following pantone solic coated colours: 'Orange Pantone 1665C' and 'Grey Pantone Cool Grey 11' (730): QUEST ION LIMITED of Unit F, 26/F, MG Tower, 133 Hoi Bun Road, Kwun Tong, Hong Kong (740): Iseme, Kamau & Maema Advocates of P.O. Box 11866 - 00400, Nairobi, Kenya

QNET

(210): 125114 (220): 14/11/2022

(300): None (511): 36((Insurance and financial) insurance; financial affairs; monetary affairs; real estate affairs) and 41(Education; providing of training; entertainment services; sporting betting, lotteries, mobile games and cultural activities) (526): Registration of this mark shall give no right to the exclusive use of the words 'HELA' and 'POA' each separately and apart from the mark as a whole. "HELA" and "POA" are Kiswahili names meaning 'Money' and 'Good' respectively. (730): SADHIRA LIMITED of P.O. Box 75581 - 00100, Nairobi, Kenya (740): None

HELA POA

(210): 125126 (220): 15/11/2022

(300): None (511): 30(Flour and other products made from cereals) (526): Registration of this mark shall give no right to the exclusive use of the words 'UNGA' and 'BORA' each separately and apart from the mark as a whole. "Changamka" and "Unga Bora" are Kiswahili words meaning 'Exciting' and 'Quality Flour' in English. (730): DANSPRIV COMPANY LIMITED of P.O. Box 12349 - 20100, Nakuru, Kenya (740): None

Changamka
UNGA BORA

(210): 125130 (220): 15/11/2022

(300): None (511): 30(Coffee) (526): Registration of this mark shall give no right to the exclusive use of the words 'GRANDEZZA', 'COFFEE', 'TASTE', 'TIME' and the devices of a 'cup' per se, 'coffee berries' and 'coffee beans' each separately and apart from the mark as a whole. (730): GRANDEZZA COFFEE of P. O. Box 7118 - 01000, Thika, Kenya (740): None



(210): 125131 (220): 15/11/2022

(300): None (511): 18(Bags and Suitcase) (526): None (730): KOT GROUP LIMITED of P.O. Box 44213 - 00100, Nairobi, Kenya (740): None

CURIOUS MAN

(210): 125132 (220): 15/11/2022

(300): None (511): 18(Bags and Suitcase) (526): None (730): KOT GROUP LIMITED of P.O. Box 44213 - 00100, Nairobi, Kenya (740): None

PRALION

(210): 125136 (220): 15/11/2022

(300): None (511): 21(Toothbrushes) (526): None (730): COLGATE-PALMOLIVE COMPANY of 300 Park Avenue, New York, NY 10022, United States of America (740): Coulson Harney Advocates of P.O. Box 10643 - 00100, Nairobi, Kenya



(210): 125137 (220): 15/11/2022

(300): None (511): 21(Toothbrushes) (526): The applicant claims the colours Red, White, Yellow And Blue Light Blue as features of the mark. (730): COLGATE-PALMOLIVE COMPANY of 300 Park Avenue, New York, NY 10022, United States of America (740): COLGATE-PALMOLIVE COMPANY of 300 Park Avenue, New York, NY 10022, United States of America (740): Coulson Harney Advocates of P.O. Box 10643 - 00100, Nairobi, Kenya

(210): 125151 (220): 16/11/2022

(300): None (511): 5(Pharmaceutical and veterinary preparations; sanitary preparations for medical purposes; dietetic substances adapted for medical use, herbal supplements, food for babies; plasters, materials for dressings; material for stopping teeth, dental wax; disinfectants, sanitizers) (526): None (730): DOLOPHARMA HEALTHCARE LTD, a limited liability company duly incorporated under the laws of Kenya of P.O. Box 102976 - 00101, Nairobi, Kenya (740): None

DOLOZIT

(210): 125158 (220): 16/11/2022

(300): None (511): 21(Goods consisting of household and kitchen utensils; small, hand-operated utensils and apparatus for household and kitchen use, as well as cosmetic and toilet utensils, glassware and certain goods made of porcelain, ceramic, earthenware, terra-cotta or glass) (526): Registration of this mark shall give no right to the exclusive use of the words "Pinnacle", "Style", "With", "Substance" and the "pyramid image" each separately and apart from the mark as a whole. The applicant claim the colors "BLUE" and "GREEN" of the mark. (730): TOKYO PLAST INTERNATIONAL LIMITED of 102, Thosar House, Hanuman Crossroad, No1, Vile Parle (E) Mumbai 57, India (740): Wanjiku Mohamed Advocates LLP of P.O. Box 34531 - 80118, Mombasa, Kenya



(210): 125172 **(220):** 16/11/2022
(300): None **(511):** 41(Education; providing of training; entertainment; sporting and cultural activities.), 43(Services for providing food and drink; temporary accommodation.) and 44(Medical services; veterinary services; hygienic and beauty care for human beings or animals; agriculture, horticulture, and forestry services.) **(526):** Registration of this mark shall give no right to the exclusive use of the words "FITNESS", "GYM", "SPA" and letters "C", "N", "S" each separately and apart from the mark as a whole. **(730):** NSC FITNESS LIMITED of P.O. Box 49194 - 00100, Nairobi, Kenya **(740):** Oraro & Company Advocates of P.O. Box 51236 - 00200, Nairobi, Kenya

NSC FITNESS GYM & SPA

(210): 125190 **(220):** 16/11/2022
(300): None **(511):** 35(Advertising; business management, organization and administration; office functions.) **(526):** None **(730):** FRANCHISE CONSORTIUM LIMITED DMCC of Unit No. 4844, DMCC Business Centre, Level No.1, Jewellery & Gemplex 3, Dubai, United Arab Emirates **(740):** Talal Abu-Ghazaleh Intellectual Property of P.O. Box 2537 - 00606, Nairobi, Kenya

OCULIS

(210): 125201 **(220):** 18/11/2022
(300): None **(511):** 41(Education; Providing of training; Entertainment services; Sporting betting, lotteries, mobile games and cultural activities.) **(526):** None **(730):** BETI FITI LIMITED of P.O. Box 20671 - 00100, Nairobi, Kenya **(740):** None

FAIR CRASH

(210): 125204 **(220):** 18/11/2022
(300): None **(511):** 41(Entertainment services.) **(526):** None **(730):** MLT ENTERTAINMENT LIMITED of P.O. Box 2756 - 00606, Nairobi, Kenya **(740):** Taibjee And Bhalla Advocates LLP of P.O. Box 10161 - 00100, Nairobi, Kenya



(210): 125205 **(220):** 18/11/2022
(300): None **(511):** 43(Services for providing food and drink; temporary accommodation.) **(526):** Registration of this mark shall give no right to the exclusive use of the words "ASIA", "ROOFTOP", "BAR" and "LOUNGE" each separately and apart from the mark as a whole. **(730):** GRANDWEST HOTEL & APARTMENTS LIMITED of P.O. Box 1919 - 00606, Nairobi, Kenya **(740):** Taibjee And Bhalla Advocates LLP of P.O. Box 10161 - 00100, Nairobi, Kenya

ASIATIC
ROOFTOP BAR & LOUNGE

(210): 125206 **(220):** 18/11/2022
(300): None **(511):** 28(Games, toys and playthings; video game apparatus; gymnastic and sporting articles; decorations for Christmas trees.), 35(Advertising; business management, organization and administration; office functions.) and 41(Education; providing of training; entertainment; sporting and cultural activities.) **(526):** Registration of this mark shall give no right to the exclusive use of the word "SPORT" separately and apart from the mark as a whole. **(730):** NATION MEDIA GROUP PLC of Nation Centre, Kimathi Street, P. O. Box 49010 - 00100, Nairobi, Kenya **(740):** Iseme, Kamau & Maema Advocates of P.O. Box 11866 - 00400, Nairobi, Kenya

SPORT ON!

(210): 125237 **(220):** 21/11/2022
(300): None **(511):** 41(Betting services) **(526):** Registration of this mark shall give no right to the exclusive use of the words "WEKA" and "BET" and the device of a 'BALL' each separately and apart from the mark as a whole. "WekaBet" is a swahili word which means 'Putting a bet'. **(730):** SIGMACS LIMITED of P.O. Box 2044 - 30200, Nairobi, Kenya **(740):** None



<p>(210): 125255 (220): 21/11/2022 (300): None (511): 5(Preparations for destroying vermin, herbicides and fungicides.) (526): None (730): SINERIA KENYA LIMITED of P.O. Box 79777 - 00200, Nairobi, Kenya (740): None</p>	VRETA
<p>(210): 125256 (220): 21/11/2022 (300): None (511): 5(Preparations for destroying vermin, herbicides and fungicides) (526): None (730): SINERIA KENYA LIMITED of P.O. Box 79777 - 00200, Nairobi, Kenya (740): None</p>	NARKE
<p>(210): 125257 (220): 21/11/2022 (300): None (511): 5(Preparations for destroying vermin, herbicides and fungicides) (526): Registration of this mark shall give no right to the exclusive use of the word "INSTANT" separately and apart from the mark as a whole. (730): SINERIA KENYA LIMITED of P.O. Box 79777 - 00200, Nairobi, Kenya (740): None</p>	
<p>(210): 125258 (220): 21/11/2022 (300): None (511): 5(Preparations for destroying vermin, herbicides and fungicides.) (526): None (730): SINERIA KENYA LIMITED of P.O. Box 79777 - 00200, Nairobi, Kenya (740): None</p>	BRINK
<p>(210): 125261 (220): 21/11/2022 (300): None (511): 45(Legal services; security services for the physical protection of tangible property and individuals; personal and social services rendered by others to meet the needs of individuals.) (526): Registration of this mark shall give no right to the exclusive use of the word "KENYA" and the letter "K" each separately and apart from the mark as a whole. 'KUUNGANA' is a Kiswahili word that translates to 'coming together' in English. 'Sauti ya mnyonge' is a Kiswahili word that translates to 'voice of the commoner' or 'wish of the weak majority'. (730): DAVID KIMENGERE WAITITU of P.O. Box 69 - 10106, Othaya, Kenya (740): None</p>	
<p>(210): 125267 (220): 22/11/2022 (300): None (511): 19(White cement based wall putty (skimming coat). (526): Registration of this mark shall give no right to the exclusive use of the word "WALLPUTTY" separately and apart from the mark as a whole. (730): DRYCHEM KENYA SOLUTIONS LTD of P.O. Box 209 - 9611, Kangundo Road, Kenya (740): None</p>	ULTRACEM WALLPUTTY
<p>(210): 125269 (220): 22/11/2022 (300): None (511): 35(Advertising; business management; business administration; office functions.) (526): Registration of this mark shall give no right to the exclusive use of the letter "R" separately and apart from the mark as a whole. (730): RAJ USHANGA (2010) LIMITED of P.O. Box 45842 - 00100, Nairobi, Kenya (740): Wairi Kamau Advocate C/O Okutta Wairi & Co Advocates of P.O Box 20136 - 00100, Nairobi, Kenya</p>	
<p>(210): 125277 (220): 22/11/2022 (300): None (511): 5(Pharmaceuticals.) (526): None (730): VINCARE CONSULTING LIMITED of P.O. Box 38222 - 00100, Nairobi, Kenya (740): None</p>	CIPRON
<p>(210): 125278 (220): 22/11/2022 (300): None (511): 5(Pharmaceuticals.) (526): None (730): VINCARE CONSULTING LIMITED of P.O. Box 38222 - 00100, Nairobi, Kenya (740): None</p>	CEPEDOX
<p>(210): 125279 (220): 22/11/2022 (300): None (511): 5(Pharmaceuticals.) (526): None (730): VINCARE CONSULTING LIMITED of P.O. Box 38222 - 00100, Nairobi, Kenya (740): None</p>	CEFUVIN
<p>(210): 125280 (220): 22/11/2022 (300): None (511): 5(Pharmaceuticals.) (526): None (730): VINCARE CONSULTING LIMITED of P.O. Box 38222 - 00100, Nairobi, Kenya (740): None</p>	AZITHROVIN

(210): 125281 (220): 22/11/2022 (300): None (511): 5(Pharmaceuticals.) (526): None (730): VINCARE CONSULTING LIMITED of P.O. Box 38222 - 00100, Nairobi, Kenya (740): None	VINBORAL
(210): 125282 (220): 22/11/2022 (300): None (511): 5(Pharmaceuticals.) (526): None (730): VINCARE CONSULTING LIMITED of P.O. Box 38222 - 00100, Nairobi, Kenya (740): None	VINAZOLE
(210): 125283 (220): 22/11/2022 (300): None (511): 5(Pharmaceuticals.) (526): None (730): VINCARE CONSULTING LIMITED of P.O. Box 38222 - 00100, Nairobi, Kenya (740): None	PANTOVIN - 20
(210): 125284 (220): 22/11/2022 (300): None (511): 5(Pharmaceuticals.) (526): None (730): VINCARE CONSULTING LIMITED of P.O. Box 38222 - 00100, Nairobi, Kenya (740): None	ESOVIN
(210): 125285 (220): 22/11/2022 (300): None (511): 5(Pharmaceuticals.) (526): None (730): VINCARE CONSULTING LIMITED of P.O. Box 38222 - 00100, Nairobi, Kenya (740): None	FERMIBIN
(210): 125286 (220): 22/11/2022 (300): None (511): 5(Pharmaceuticals.) (526): None (730): VINCARE CONSULTING LIMITED of P.O. Box 38222 - 00100, Nairobi, Kenya (740): None	FLUCONA-VIN
(210): 125287 (220): 22/11/2022 (300): None (511): 5(Pharmaceuticals.) (526): Registration of this mark shall give no right to the exclusive use of the word "KIT" and the letters 'H' and 'P' each separately and apart from the mark as a whole. (730): VINCARE CONSULTING LIMITED of P.O. Box 38222 - 00100, Nairobi, Kenya (740): None	NEXPRAZ -HP KIT
(210): 125288 (220): 22/11/2022 (300): None (511): 5(Pharmaceuticals.) (526): Registration of this mark shall give no right to the exclusive use of the letter 'D' separately and apart from the mark as a whole. (730): VINCARE CONSULTING LIMITED of P.O. Box 38222 - 00100, Nairobi, Kenya (740): None	NEXPRAZV D
(210): 125289 (220): 22/11/2022 (300): None (511): 5(Pharmaceuticals.) (526): None (730): VINCARE CONSULTING LIMITED of P.O. Box 38222 - 00100, Nairobi, Kenya (740): None	ONDASEN
(210): 125290 (220): 22/11/2022 (300): None (511): 5(Pharmaceuticals.) (526): None (730): VINCARE CONSULTING LIMITED of P.O. Box 38222 - 00100, Nairobi, Kenya (740): None	ORNIDIN
(210): 125291 (220): 22/11/2022 (300): None (511): 5(Pharmaceuticals.) (526): None (730): VINCARE CONSULTING LIMITED of P.O. Box 38222 - 00100, Nairobi, Kenya (740): None	SECNICARE
(210): 125317 (220): 23/11/2022 (300): None (511): 1(Chemicals used in industry, science and photography, as well as in agriculture, horticulture and forestry; unprocessed artificial resins, unprocessed plastics; manures; fire extinguishing compositions; tempering and soldering preparations; chemical substances for preserving foodstuffs; tanning substances; adhesives used in industry.) (526): None (730): KOPPERT BIOLOGICAL SYSTEMS of P.O. Box 41852 - 00100, Nairobi, Kenya (740): None	ENERMIX

ERCAL**(210):** 125318 **(220):** 23/11/2022**(300):** None **(511):** 1(Chemicals used in industry, science and photography, as well as in agriculture, horticulture and forestry; unprocessed artificial resins, unprocessed plastics; manures; fire extinguishing compositions; tempering and soldering preparations; chemical substances for preserving foodstuffs; tanning substances; adhesives used in industry.) **(526):** None **(730):** KOPPERT BIOLOGICAL SYSTEMS of P.O. Box 41852 - 00100, Nairobi, Kenya **(740):** None**ENTONEM****(210):** 125319 **(220):** 23/11/2022**(300):** None **(511):** 1(Chemicals used in industry, science and photography, as well as in agriculture, horticulture and forestry; unprocessed artificial resins, unprocessed plastics; manures; fire extinguishing compositions; tempering and soldering preparations; chemical substances for preserving foodstuffs; tanning substances; adhesives used in industry.) **(526):** None **(730):** KOPPERT BIOLOGICAL SYSTEMS of P.O. Box 41852 - 00100, Nairobi, Kenya **(740):** None**(210):** 125354 **(220):** 25/11/2022**(300):** None **(511):** 45(Legal services.) **(526):** Registration of this mark shall give no right to the exclusive use of the words "ADERA", "CONSULTANCY", "LAW" and the device of "scales of justice" each separately and apart from the mark as a whole. **(730):** STEPHEN BIKO ADERA of P.O. Box 2060 - 00502, Nairobi, Kenya **(740):** None**SWIFT RANGE****(210):** 125364 **(220):** 25/11/2022**(300):** None **(511):** 10(Medical apparatus) **(526):** None **(730):** VINCARE CONSULTING LIMITED of P.O. Box 38222 - 00100, Nairobi, Kenya **(740):** None**(210):** 125365 **(220):** 25/11/2022**(300):** None **(511):** 29(Milk and milk products) **(526):** Registration of this mark shall give no right to the exclusive use of the device of the 'leaves' separately and apart from the mark as a whole. **(730):** PEARL DAIRY FARMS LIMITED of Plot 29b, Acacia Avenue, Kololo, Kampala, Uganda PO:7420, Uganda **(740):** Timothy Got Ondego Advocates of P.O. Box 1301 - 00200, Nairobi, Kenya**(210):** 125366 **(220):** 25/11/2022**(300):** None **(511):** 32(Syrups and other preparations for making beverages) **(526):** Registration of this mark shall give no right to the exclusive use of the device of the 'leaves' separately and apart from the mark as a whole. **(730):** PEARL DAIRY FARMS LIMITED of Plot 29b, Acacia Avenue, Kololo, Kampala, Uganda PO:7420, Uganda **(740):** Timothy Got Ondego Advocates of P.O. Box 1301 - 00200, Nairobi, Kenya**(210):** 125372 **(220):** 28/11/2022**(300):** None **(511):** 32(Fruit beverages; fruit juice; non-alcoholic fruit beverages; non-alcoholic fruit extracts; fruit nectars (non-alcoholic); non-alcoholic beverages; non-alcoholic fruit juice beverages; isotonic beverages; preparations for making beverages) **(526):** None **(730):** KENINDO GLOBAL LIMITED of P.O. Box 8134 - 00610, Nairobi, Kenya **(740):** None

(210): 125408 (220): 29/11/2022

(300): None (511): 34(Lighters for smokers; articles for smokers; matches; gas tank for lighters; pocket lighter stones; electric cigarettes; electric cigars; electric pipes; smoking simulators, namely electronic cigarettes, cigars and pipes without tobacco, other than for medical purposes; flavourings, other than essential oils, for electronic cigarettes; liquid solutions with or without nicotine for electronic cigarettes; tobacco.) (526): None (730): FLAMAGAS, S.A. of Calle Metalurgia, 38-42 08038 Barcelona, Spain (740): CFL Advocates of P.O. Box 23555 - 00100, Nairobi, Kenya

CLIPPER

(210): 125410 (220): 29/11/2022

(300): None (511): 1(Fertilizer.) (526): Registration of this mark shall give no right to the exclusive use of the device of 'leaves on crop branch' separately and apart from the mark as a whole. (730): FAIRLANE AGRISERVICES AND SUPPLIES of P.O. Box 2189 - 20300, Nyahururu, Kenya (740): None



(210): 125413 (220): 29/11/2022

(300): None (511): 33(Alcoholic beverages (except beers). (526): Registration of this mark shall give no right to the exclusive use of the word "WILD" separately and apart from the mark as a whole. (730): DIAGEO NORTH AMERICA, INC., a corporation of Connecticut, U.S.A. of Three World Trade Center, 175 Greenwich Street, New York, New York 10007, United States of America (740): Coulson HarneyHarnet of P.O. Box 10643 - 00100, Nairobi, Kenya

WILD HEAT

(210): 125419 (220): 30/11/2022

(300): None (511): 1(Chemicals used in industry, science and photography, as well as in agriculture, horticulture and forestry; unprocessed artificial resins, unprocessed plastics; manures; fire extinguishing compositions; tempering and soldering preparations; chemical substances for preserving foodstuffs; tanning substances; adhesives used in industry) (526): Registration of this mark shall give no right to the exclusive use of the word "VITAL" separately and apart from the mark as a whole. (730): KOPPERT BIOLOGICAL SYSTEMS of P.O. 41852 - 00100, Nairobi, Kenya (740): None

SPIDEX VITAL

(210): 125420 (220): 30/11/2022

(300): None (511): 1(Chemicals used in industry, science and photography, as well as in agriculture, horticulture and forestry; unprocessed artificial resins, unprocessed plastics; manures; fire extinguishing compositions; tempering and soldering preparations; chemical substances for preserving foodstuffs; tanning substances; adhesives used in industry) (526): Registration of this mark shall give no right to the exclusive use of the letter "L" separately and apart from the mark as a whole. (730): KOPPERT BIOLOGICAL SYSTEMS of P.O. Box 41852 - 00100, Kenya (740): None

CRYPTOBUG-L

(210): 125421 (220): 30/11/2022

(300): None (511): 1(Chemicals used in industry, science and photography, as well as in agriculture, horticulture and forestry; unprocessed artificial resins, unprocessed plastics; manures; fire extinguishing compositions; tempering and soldering preparations; chemical substances for preserving foodstuffs; tanning substances; adhesives used in industry) (526): Registration of this mark shall give no right to the exclusive use of the letter "M" separately and apart from the mark as a whole. (730): KOPPERT BIOLOGICAL SYSTEMS of P.O. Box 41852 - 00100, Nairobi, Kenya (740): None

ENTOMITE - M

(210): 125422 (220): 30/11/2022

(300): None (511): 5(Medicinal and Pharmaceutical Preparations.) (526): None (730): WOCKHARDT LIMITED AN INDIAN PUBLIC LIMITED COMPANY of Wockhardt Towers, Bandra Kurla Complex, Mumbai - 400051, India (740): CFL Advocates of P.O. Box 23555 - 00100, Nairobi, Kenya

SUGAWOK

(210): 125429 **(220):** 30/11/2022

(300): None **(511):** 9(Mobile telephones; batteries, electric; battery chargers; cabinets for loudspeakers; data transmission cables; earphones; notebook computers; tablet computers; network routers; photographic cameras; mobile phone chargers; computer keyboards; face recognition equipment; wearable video display monitors; wearable activity trackers; television apparatus; virtual reality headsets; portable power supplies [rechargeable batteries]; smartwatches; smart bracelets; cameras; wireless communication devices; computer mouse; smartglasses.) **(526):** None **(730):** TECNO TELECOM(HK) LIMITED of Flat N, 16/F., Block B, Universal Industrial Centre, 19-25 Shan Mei Street, Fotan, New Territories, Hong Kong, China **(740):** CFL Advocates of P.O. Box 23555 - 00100, Nairobi, Kenya

COZITEC**(210):** 125430 **(220):** 30/11/2022

(300): None **(511):** 9(Mobile telephones; batteries, electric; battery chargers; cabinets for loudspeakers; data transmission cables; earphones; notebook computers; tablet computers; network routers; photographic cameras; mobile phone chargers; computer keyboards; face recognition equipment; wearable video display monitors; wearable activity trackers; television apparatus; virtual reality headsets; portable power supplies [rechargeable batteries]; smartwatches; smart bracelets; cameras; wireless communication devices; computer mouse; smartglasses.) **(526):** None **(730):** TECNO TELECOM(HK) LIMITED of Flat N, 16/F., Block B, Universal Industrial Centre, 19-25 Shan Mei Street, Fotan, New Territories, Hong Kong, China **(740):** CFL Advocates of P.O. Box 23555 - 00100, Nairobi, Kenya

UNSEEN**(210):** 125454 **(220):** 01/12/2022

(300): None **(511):** 10(Surgical, medical, dental and veterinary apparatus and instruments, artificial limbs, artificial eyes and teeth; orthopaedic articles; and suture materials.) **(526):** Registration of this mark shall give no right to the exclusive use of the words 'Gloves', 'Hands', 'Protected', 'Quality', the 'plus' sign and the devices of 'gloves' each separately and apart from the mark as a whole. **(730):** DASHVOY KENYA LIMITED of P.O. Box 76750 - 00620, Nairobi, Kenya **(740):** None

**(210):** 125460 **(220):** 02/12/2022

(300): None **(511):** 35(Business management) **(526):** Registration of this mark shall give no right to the exclusive use of the word 'STORE' and letter 'O' each separately and apart from the mark as a whole. **(730):** OVO STORE LTD. of Kenya **(740):** None

**(210):** 125476 **(220):** 05/12/2022

(300): None **(511):** 3(Beauty products), 41(Beauty school) and 44(Salon/ beauty parlor) **(526):** Registration of this mark shall give no right to the exclusive use of the word 'Face' and the letters 'B' and 'X' each separately and apart from the mark as a whole. "BAMBI" is a coined word, hence has no meaning in English. **(730):** SUAD HUSSEIN MOHAMED of P.O. Box 1953 - 00100, Nairobi, Kenya **(740):** None

**(210):** 125480 **(220):** 05/12/2022

(300): None **(511):** 16(Paper, cardboard and goods made from these materials, not included in other classes; printed matter; bookbinding material; photographs; stationery; adhesives for stationery or household purposes; artists' materials; paint brushes; typewriters and office requisites (except furniture); instructional and teaching material (except apparatus); plastic materials for packaging (not included in other classes); printers' type; printing blocks), 35(Advertising; business management; business administration; office functions) and 41(Education; providing of training; entertainment; sporting and cultural activities) **(526):** Registration



of this mark shall give no right to the exclusive use of the letters 'M', 'S', 'F', 'K' and the device of the 'Kenyan flag colours' each separately and apart from the mark as a whole. **(730)**: MOTORCYCLE SPORTS FEDERATION OF KENYA of P.O. Box 42786 - 00100, 162 James Gichuru, Lavington, Nairobi, Kenya **(740)**: Seslaw Advocates of 7th Floor Wuyi Plaza, Galana Road, Kilimani, Nairobi

(210): 125485 **(220)**: 05/12/2022

(300): None **(511)**: 30(Coffee, tea, cocoa and artificial coffee; Rice; Tapioca and sago; Flour and preparations made from cereals; Bread, pastry and confectionery; Edible ices; Sugar, honey, treacle; Yeast, baking-powder; Salt; Mustard; Vinegar, sauces (condiments); Spices; Ice.) **(526)**: Registration of this mark shall give no right to the exclusive use of the devices of 'maize cob', 'wheat grain and sorghum' and the words 'Flour', 'Excellent', 'Mid' and 'Rift' each separately and apart from the mark as a whole **(730)**: LUKE KERICH of P.O. Box 3106 - 80100, Mombasa, Kenya **(740)**: None



(210): 125499 **(220)**: 05/12/2022

(300): None **(511)**: 11(Apparatus for lighting) **(526)**: The translation into English of the word 'KAKa' is 'Brother' **(730)**: JETA CO. LTD of P.O. Box 19875 - 00100, Nairobi, Kenya **(740)**: None

KAKA

(210): 125511 **(220)**: 08/12/2022

(300): None **(511)**: 11(Air conditioning apparatus; air conditioners; electric air coolers, air cleaners: bread toasters; electric coffee machines and percolators; cookers; electric cooking utensils: electric deep fryers; electric lamps; electric blenders; electric dry iron box: fans (air-conditioning); freezers, refrigerators: heating apparatus; hot air apparatus; electric heaters; electric clothes heating machine with deodorization and crease-resistant treatment; ceramic electric heaters; Electric laundry dryers for household purposes; Electric gas laundry drying machines; Electric laundry drying machines: Electric clothes dryers; Electric clothes drying machines with sterilization/ deodorization and crease-resistant treatment functions for household purposes; steam iron brush; steam dry iron box; steam Iron box; sterilizers; humidifiers and dehumidifiers; uninterruptible power supply generating installations and apparatus; apparatus for lighting, apparatus for heating purposes, Light Emitting Diode(LED) lighting; Plasma lighting System [PLS) lighting; apparatus for steam generating purposes, apparatus for cooking purposes, apparatus for refrigerating purposes, apparatus for drying purposes, apparatus for ventilating purposes, apparatus for water supply purposes, water purifiers, apparatus for sanitary purposes; solar collectors; electric kettles; electric jugs, electric coffee makers, electric mocha makers; electric espresso makers; toasters, sandwich toasters, oven toasters, ovens, electric kitchen oven; gas cookers; microwave ovens (cooking apparatus); waffle makers; sandwich makers; hot dog and hamburger makers; hot pots; steam cookers; electric cooking plates; electric food steamers, rotisseries; electric pizza makers; electric egg boilers; frying machines; desk, stand, wall and ceiling fans; domestic and industrial exhaust fans; fan heaters; fluorescent lamps; fluorescent tubes; Oil filled radiators; water heaters; convector heaters; hair dryers; bread makers (electric); electric rice cookers; pressure cookers; apparatus for filtering, softening and purifying water; Water heaters, shower accessories, sanitary valve, bathroom accessories; Gas cooking plates, free standing gas cookers, built in gas cookers, and table top gas cookers parts and fittings) **(526)**: Registration of this mark shall give no right to the exclusive use of the letter 'Z' and the word 'QUALITY' separately and apart from the mark as a whole. **(730)**: SYDUS VENTURES LIMITED of P.O. Box 56639 - 00200, Nairobi, Kenya **(740)**: None



(210): 125512 (220): 08/12/2022

(300): None (511): 3(Cosmetics, petroleum jelly, shampoo, liquid soap) (526): Registration of this mark shall give no right to the exclusive use of the device of a 'star' separately and apart from the mark as a whole. (730): NATURE FIRM TRADING COMPANY LIMITED of P.O. Box 879 - 00610, Eastleigh Jam Street, Nairobi, Kenya (740): None



(210): 125540 (220): 08/12/2022

(300): None (511): 42(Scientific and Technological Services) (526): 'Mosmos' is a Luo word meaning 'Slowly' in English. (730): ASENATECH LIMITED of 10th Floor, ABC Place, Waiyaki Way, P.O. Box 2417 - 00606, Nairobi, Kenya (740): None



(210): 125557 (220): 09/12/2022

(300): None (511): 16(Paper, cardboard and goods made from these materials, not included in other classes; printed matter; bookbinding material; photographs; stationery; adhesives for stationery or household purposes; artists' materials; paint brushes; typewriters and, office requisites (except furniture); instructional and teaching material (except apparatus); plastic materials for packaging (not included in other classes); playing cards; printers' type; printing blocks), 25(Clothing, footwear, and headgear.), 35(Advertising; business management; business administration; office functions. Presentation of goods on communication media for retail purposes; providing information related to polymer manufactured goods in the field of greenhouse technology and greenhouse plastics, dam liners; Wholesale and retail store services featuring goods and services in the field of greenhouse technology and greenhouse plastics, dam liners.), 36(Insurance; financial affairs; monetary affairs; real estate affairs) and 38(Telecommunication;) (526): None (730): BRIDGE TECHNOLOGIES LIMITED of Riverside Drive, Kofisi Center, 11th Floor, Nairobi, Kenya (740): Akedi & Olalo Advocates of P.O. Box 57367 - 00200, Nairobi, Kenya



(210): 125613 (220): 13/12/2022

(300): None (511): 16(Paper and cardboard; printed matter; bookbinding material; photographs; stationery and office requisites, except furniture; adhesives for stationery or household purposes; artists' and drawing materials; paintbrushes; typewriters and office requisites (except furniture); instructional and teaching materials (except apparatus); plastic sheets, films and bags for wrapping and packaging; printers' type; printing blocks) and 35(Advertising; business management; business administration; office functions) (526): None (730): ORRADA LTD. of P.O. Box 32764 - 00600, Nairobi, Kenya (740): None

Note it
DOWN

(210): 125614 (220): 13/12/2022

(300): None (511): 9(Microphones, powered mixers, power amplifier, speaker cables, speakers) (526): None (730): COMPE AUDIO LIMITED of P.O. Box 57921 - 00200, Nairobi, Kenya (740): None

EVOLUTION

(210): 125615 (220): 13/12/2022

(300): None (511): 9(Microphones, powered mixers, power amplifier, speaker cables, speakers) (526): Registration of this mark shall give no right to the exclusive use of the word 'BLUE' separately and apart from the mark as a whole. (730): COMPE AUDIO LIMITED of P.O. Box 57921 - 00200, Nairobi, Kenya (740): None

BLUE WHALE

(210): 125626 (220): 13/12/2022

(300): None (511): 30(Iced tea; tea; beverages with tea base; loose leaf teas; whole-leaf orthodox teas.) (526): Registration of this mark shall give no right to the exclusive use of the words 'ORIGIN', 'ICE' and 'TEA' each separately and apart from the mark as a whole. (730): TASTE THE ORIGIN KE LTD of Thigiri Ridge Road, New Muthaiga, P. O. Box 610 - 00606, Nairobi, Kenya (740): Mwasame Koya & Company Advocates of P. O. Box 9184 - 00100, Nairobi, Kenya

ORIGIN
ice tea

WG

(210): 125628 (220): 14/12/2022

(300): None (511): 1(Chemicals used in industry, science and photography, as well as in agriculture, horticulture and forestry; unprocessed artificial resins, unprocessed plastics; manures; fire extinguishing compositions; tempering and soldering preparations; chemical substances for preserving foodstuffs; tanning substances; adhesives used in industry.) (526): None (730): FARM INPUT PROMOTIONS AFRICA LIMITED of Mashiara Park, Off Kaptagat, P. O. Box 5523 - 00200, Nairobi, Kenya (740): Khayesi Njambi and Khayesi Advocates of P. O. Box 7989 - 00300, Nairobi, Kenya

(210): 125646 (220): 14/12/2022

(300): None (511): 43(Services for providing food and drink; temporary accommodation) (526): Registration of this mark shall give no right to the exclusive use of the words 'FRY' separately and apart from the mark as a whole. (730): STAN FRY'S LIMITED of Pangani Shopping Centre, P. O. Box 66161 - 00800, Nairobi, Kenya (740): Komu & Kamenju Advocates of P.O. Box 60533 - 00200, Nairobi, Kenya

Stan Fry's

(210): 125671 (220): 15/12/2022

(300): None (511): 45(Personal and social services) (526): Registration of this mark shall give no right to the exclusive use of the word "Team" separately and apart from the mark as a whole. (730): JITEN PARBAT KERALA of P.O. Box 3787 - 00506, Nairobi, Kenya (740): Kaweesa & Company Advocates of P.O. Box 74236 - 00200, Nairobi, Kenya



(210): 125673 (220): 15/12/2022

(300): None (511): 25(Shoes) (526): Registration of this mark shall give no right to the exclusive use of the device of "SHOES" separately and apart from the mark as a whole. (730): KOT GROUP LIMITED of P. O. Box 44213 - 00100, Nairobi, Kenya (740): None

Suvis
Go further

(210): 125674 (220): 15/12/2022

(300): None (511): 25(SHOES) (526): Registration of this mark shall give no right to the exclusive use of the words "COMFORT" and "QUALITY" each separately and apart from the mark as a whole. (730): KOT GROUP LIMITED of P.O. Box 44213 - 001000, Nairobi, Kenya (740): None

Lanser
COMFORT & QUALITY

(210): 125701 (220): 16/12/2022

(300): None (511): 36(Insurance; Financial affairs; Monetary affairs; Real estate affairs) and 41(Education; Providing of training; Entertainment; Sporting and Cultural activities) (526): Registration of this mark shall give no right to the exclusive use of the word 'ONE' separately and apart from the mark as a whole. The mark is restricted to colours "Dark blue" and "Beige" as shown in the representation. (730): VDH DEVELOPMENTS LIMITED of P.O. Box 51 - 80404, Msambweni House & One Ocean, Msambweni, Kenya (740): Daly Inamdar Advocates LLP of P.O. Box 40034 - 00100, Nairobi, Kenya

ONE OCEAN

(210): 125702 **(220):** 16/12/2022**(300):** None **(511):** 36(Insurance; Financial affairs; Monetary affairs; Real estate affairs) and 41(Education; Providing of training; Entertainment; Sporting and Cultural activities) **(526):** Registration of this mark shall give no right to the exclusive use of the words 'ONE', 'LUXURY' and 'LIFESTYLE' each separately and apart from the mark as a whole. The mark is restricted to colours 'Dark blue' and 'Beige' as shown in the representation. **(730):** VDH DEVELOPMENTS LIMITED of P.O. Box 51 - 80404, Msambweni House & One Ocean, Msambweni, Kenya **(740):** Daly Inamdar Advocates LLP of P.O. Box 40034 - 00100, Nairobi, Kenya**(210):** 125703 **(220):** 16/12/2022**(300):** None **(511):** 36(Insurance; Financial affairs; Monetary affairs; Real estate affairs.) and 41(Education; Providing of training; Entertainment; Sporting and Cultural activities.) **(526):** Registration of this mark shall give no right to the exclusive use of the words 'ONE', 'LUXURY', 'RESORT', 'VILLA', 'APARTMENTS' and the symbol '&' each separately and apart from the mark as a whole. The mark is restricted to colours 'Dark blue' and 'Beige' as shown in the representation. **(730):** VDH DEVELOPMENTS LIMITED of P.O. Box 51 - 80404, Msambweni House & One Ocean, Msambweni, Kenya **(740):** Daly Inamdar Advocates LLP of P.O. Box 40034 - 00100, Nairobi, Kenya**(210):** 125704 **(220):** 16/12/2022**(300):** None **(511):** 29(Milk and milk products) **(526):** Registration of this mark shall give no right to the exclusive use of the word 'GOLD', the device of a 'child' and 'leaves' each separately and apart from the mark as a whole. **(730):** PEARL DAIRY FARMS LIMITED, a company registered in Uganda under number 107603 of Plot 29B, Acacia Avenue, Kololo, Kampala, P.O. Box 7420, Kampala, Uganda **(740):** Timothy Got Ondego Advocates of P. O. Box 1301 - 00200, Nairobi, Kenya**(210):** 125705 **(220):** 16/12/2022**(300):** None **(511):** 30(Flour and preparations made from cereals) **(526):** None **(730):** PEARL DAIRY FARMS LIMITED, a company registered in Uganda under number 107603 of Plot 29B, Acacia Avenue, Kololo, Kampala, P.O. Box 7420, Kampala, Uganda **(740):** Timothy Got Ondego Advocates of P. O. Box 1301 - 00200, Nairobi, Kenya**"CHEZA469"****(210):** 125711 **(220):** 16/12/2022**(300):** None **(511):** 41(Education; Providing training; Entertainment; Sporting and Cultural activities) **(526):** Registration of this mark shall give no right to the exclusive use of the word 'CHEZA' and the numerals '4', '6' and '9' each separately and apart from the mark as a whole. "CHEZA" is a swahili word, whose English translation is 'Play'. **(730):** LIBERTY AFRIKA TECHNOLOGIES LIMITED of P. O. Box 20000 - 00100, Nairobi, Kenya **(740):** Kiingati Ndirangu & Associates Advocates of P. O. Box 18677 - 00100, Nairobi, Kenya**(210):** 125712 **(220):** 16/12/2022**(300):** None **(511):** 5(Medicinal and Pharmaceutical preparations for treatment of Diabetes.) **(526):** None **(730):** SUN PHARMACEUTICAL INDUSTRIES LIMITED of Sun House, Plot No. 201 B/1, Western Express Highway, Goregaon (E), Mumbai-400 063, Maharashtra, India **(740):** CFL Advocates of P. O. Box 23555 - 00100, Nairobi, Kenya**DAPSUN****(210):** 125713 **(220):** 16/12/2022**(300):** None **(511):** 3(Cleaning detergent) **(526):** None **(730):** XPAT PRODUCTS SERVICES LTD of P. O. Box 35438 - 00100, Nairobi, Kenya **(740):** None**XPAT**

(210): 125714 **(220):** 16/12/2022
(300): None **(511):** 32(Beers; non-alcoholic beverages; mineral and aerated waters; fruit beverages and fruit juices; syrups and other preparations for making non-alcoholic beverages.) **(526):** Registration of this mark shall give no right to the exclusive use of the letter 'F' separately and apart from the mark as a whole. **(730):** THE COCA-COLA COMPANY of One Coca-Cola Plaza, Atlanta, GA 30313, Atlanta, United States of America **(740):** Iseme, Kamau & Maema Advocates of P. O. Box 11866 - 00400, Nairobi, Kenya



BUPAMAX

(210): 125715 **(220):** 16/12/2022
(300): None **(511):** 5(Pharmaceuticals and Veterinary preparations)
(526): None **(730):** KENCROP KENYA LIMITED of P. O. Box 45191 - 00100, Nairobi, Kenya **(740):** None

SEED PRO 30WS

(210): 125716 **(220):** 16/12/2022
(300): None **(511):** 5(Preparations for destroying vermin, herbicides and fungicides) **(526):** Registration of this mark shall give no right to the exclusive use of the word 'SEED', the numerals '0', '3' and the letters 'W' and 'S' each separately and apart from the mark as a whole. **(730):** SINERIA KENYA LIMITED of P.O. Box 79777 - 00200, Nairobi, Kenya **(740):** None

SVALKKA

(210): 125717 **(220):** 16/12/2022
(300): None **(511):** 5(Preparations for destroying vermin, herbicides and fungicides) **(526):** None **(730):** SINERIA KENYA LIMITED of P.O. Box 79777 - 00200, Nairobi, Kenya **(740):** None

(210): 125721 **(220):** 19/12/2022
(300): None **(511):** 29(Reserved, frozen, dried and cooked fruits and vegetables; Edible oils and fats.) **(526):** Registration of this mark shall give no right to the exclusive use of the words 'SOLAI', 'HIGHLANDS', 'WHOLE', 'NUTS' and the devices of the 'MACADAMIA NUTS' per se each separately and apart from the mark as a whole. **(730):** KENSALT LIMITED of P. O. Box 50315 - 00500, Nairobi, Kenya **(740):** None



(210): 125722 **(220):** 19/12/2022
(300): None **(511):** 29(Preserved, frozen, dried and cooked fruits and vegetables; Edible oils and fats.) **(526):** Registration of this mark shall give no right to the exclusive use of the words 'Solai', 'Highlands', 'Whole', 'Nuts' and the device of the 'macadamia nuts' per se each separately and apart from the mark as a whole. **(730):** KENSALT LIMITED of P.O. Box 50315 - 00500, Nairobi, Kenya **(740):** None



(210): 125723 **(220):** 19/12/2022
(300): None **(511):** 43(Fast food) **(526):** Registration of this mark shall give no right to the exclusive use of the words 'FAST', 'FOOD', 'BAR' and the letter 'P' per se each separately and apart from the mark as a whole. **(730):** PIZARRA ENTERPRISES LTD of Reliance Business Park, Ruiru Kamakis Area, P. O. Box 25372 - 00100, Nairobi, Kenya **(740):** None



SANDUK

(210): 125724 **(220):** 19/12/2022
(300): None **(511):** 35(Advertising; business management, organization and administration; office functions.) and 36(Financial, monetary and banking services; insurance services; real estate services.) **(526):** None **(730):** SANDUK TECHNOLOGY KENYA LIMITED of Westpark Towers, 12th Floor, Westlands, Off Parklands Road, P. O. Box 14100 - 00100, Nairobi, Kenya **(740):** None

(210): 125726 **(220):** 19/12/2022**(300):** None **(511):** 35(Advertising; business management, organization and administration; office functions.) **(526):** Registration of this mark shall give no right to the exclusive use of the words 'AGENCY', 'AFRICA' and letter 'A' each separately and apart from the mark as a whole. **(730):** NIMISH HADOLE of P. O. Box 38190 - 00623, Nairobi, Kenya **(740):** Soita & Associates Advocates of P. O. Box 14641 - 00800, Nairobi, Kenya**(210):** 125737 **(220):** 20/12/2022**(300):** None **(511):** 5(Pharmaceutical preparations) **(526):** None **(730):** CAREPLUS LIMITED of P. O. Box 13742 - 00800, Nairobi, Kenya **(740):** None**CARELEXIN****(210):** 125738 **(220):** 20/12/2022**(300):** None **(511):** 5(Pharmaceutical preparations) **(526):** None **(730):** CAREPLUS LIMITED of P. O. Box 13742 - 00800, Nairobi, Kenya **(740):** None**CAZIDINE****(210):** 125739 **(220):** 20/12/2022**(300):** None **(511):** 5(Pharmaceutical preparations) **(526):** None **(730):** CAREPLUS LIMITED of P. O. Box 13742 - 00800, Nairobi, Kenya **(740):** None**CEFIPLUS****(210):** 125740 **(220):** 20/12/2022**(300):** None **(511):** 5(Pharmaceutical preparations) **(526):** None **(730):** CAREPLUS LIMITED of P. O. Box 13742 - 00800, Nairobi, Kenya **(740):** None**FEROXIL****(210):** 125741 **(220):** 20/12/2022**(300):** None **(511):** 5(Pharmaceutical preparations) **(526):** None **(730):** CAREPLUS LIMITED of P. O. Box 13742 - 00800, Nairobi, Kenya **(740):** None**ZITHROPLUS****(210):** 125742 **(220):** 20/12/2022**(300):** None **(511):** 42(Scientific and technological services and research and design relating thereto; industrial analysis and research services; design and development of computer hardware and software;) **(526):** Registration of this mark shall give no right to the exclusive use of the letter 'E' and the mark '!' each separately and apart from the mark as a whole. **(730):** PAUL MUINDI MBINGU of 2nd Floor Nb12 Baseline Apartments Jamhuri Estate of P. O. Box 49010 - 00100, Nairobi, Kenya **(740):** Josephine A. Oyombe of P. O. Box 51134 - 00100, Nairobi, Kenya**(210):** 125743 **(220):** 20/12/2022**(300):** None **(511):** 42(Scientific and technological services and research and design relating thereto; industrial analysis and research services; design and development of computer hardware and software.) **(526):** Registration of this mark shall give no right to the exclusive use of the words 'Innovation', 'Company', the letter 'E' and the mark '!' each separately and apart from the mark as a whole. **(730):** PAUL MUINDI MBINGU of 2nd Floor Nb12 Baseline Apartments Jamhuri Estate of P. O. Box 49010 - 00100, Nairobi, Kenya **(740):** Josephine A. Oyombe of P. O. Box 51134 - 00100, Nairobi, Kenya**(210):** 125749 **(220):** 20/12/2022**(300):** None **(511):** 5(Dietary supplement) **(526):** Registration of this mark shall give no right to the exclusive use of the word 'Gut' and the device of a 'stomach' each separately and apart from the mark as a whole. **(730):** NEER HEALTHCARE LTD of 4th Floor TRV Centre, 3rd Parkland Avenue, P.O. Box 47337 - 00100, Nairobi, Kenya **(740):** None**(210):** 125751 **(220):** 20/12/2022**(300):** None **(511):** 38(Telecommunications) **(526):** None **(730):** HAICOM LIMITED of Diagorou 4, Kermia Building, 6th Floor Office 601,1097, Nicosia, Cyprus **(740):** Mema Advocates LLP of P.O. Box 50719 - 00200, Nairobi, Kenya**lemonrise**

(210): 125752 (220): 20/12/2022

(300): None (511): 42(Design and development of computer hardware and software) (526): None (730): HAICOM LIMITED of Diagorou 4, Kermia Building, 6th Floor Office 601,1097, Nicosia, Cyprus (740): Mema Advocates LLP of P.O. Box 50719 - 00200, Nairobi, Kenya

lemonrise

(210): 125753 (220): 20/12/2022

(300): None (511): 9(Data processing equipment and computers) (526): None (730): HAICOM LIMITED of Diagorou 4, Kermia Building, 6th Floor Office 601,1097, Nicosia, Cyprus (740): Mema Advocates LLP of P.O. Box 50719 - 00200, Nairobi, Kenya

lemonrise

(210): 125767 (220): 21/12/2022

(300): None (511): 1(Chemicals used in industry, science and photography, as well as in agriculture, horticulture and forestry; unprocessed artificial resins, unprocessed plastics; manures, fire extinguishing compositions; tempering and soldering preparations; chemical substances, adhesives used in industry.) (526): None (730): KOPPERT BIOLOGICAL SYSTEMS of P.O. Box 41852 - 00100, Nairobi, Kenya (740): None

CAPIREL

(210): 125768 (220): 21/12/2022

(300): None (511): 1(Chemicals used in industry, science and photography, as well as in agriculture, horticulture and forestry; unprocessed artificial resins, unprocessed plastics; manures, fire extinguishing compositions; tempering and soldering preparations; chemical substances, adhesives used in industry.) (526): None (730): KOPPERT BIOLOGICAL SYSTEMS of P.O. Box 41852 - 00100, Nairobi, Kenya (740): None

CAPSANEM

(210): 125769 (220): 21/12/2022

(300): None (511): 1(Chemicals used in industry, science and photography, as well as in agriculture, horticulture and forestry; unprocessed artificial resins, unprocessed plastics; manures, fire extinguishing compositions; tempering and soldering preparations; chemical substances, adhesives used in industry.) (526): None (730): KOPPERT BIOLOGICAL SYSTEMS of P.O. Box 41852 - 00100, Nairobi, Kenya (740): None

METARRIL

(210): 125829 (220): 23/12/2022

(300): None (511): 1(Diesel engine exhaust gases converter fluid, sodium lauryl sulfuric acid, lauryl ether sulfate, triethanolamine, sodium lauryl ether sulfate, coconut fatty acid diethanolamide, drilling foam, industrial cleaning materials, cocoamidopropyl hydroxysultine, Cocoamidopropylamine oxide, sulfamic acid, ethylene glycol, sulfonic acid, Sodium Lauryl Ether Sulfate), 3(Fabric softener, dishwashing powder, washing powder, laundry liquid, CD, DVD cleaning spray, window cleaning liquid.), 35(Advertising, export, buying and selling.) and 39(Packaging of goods.) (526): None (730): PADA SYNERGY GROUP LIMITED of P.O. Box 38101 - 00100, Nairobi, Kenya (740): None

HEXA

(210): 125850 (220): 03/01/2023

(300): None (511): 5(Pharmaceuticals, medical and veterinary preparations; sanitary preparations for medical purposes; dietetic food and substances adapted for medical or veterinary use, food for babies; dietary supplements for human beings and animals; plasters, materials for dressings; material for stopping teeth, dental wax; disinfectants; preparations for destroying vermin; fungicides, herbicides; nematocides; insecticides.) (526): None (730): AMVAC CHEMICAL CORPORATION of 4695 MacArthur Court, Suite 1200 Newport Beach, California 92660, United States of America (740): CFL Advocates of P. O. Box 23555 - 00100, Nairobi, Kenya

MOCAP

(210): 125853 (220): 03/01/2023

AMAZON SAGEMAKER

(300): None (511): 9(Computer software development tools for data scientists; computer software for developing, deploying, updating and monitoring the performance of machine learning, deep learning and artificial intelligence applications.) and 42(Software as a service featuring software development tools for data scientists; software as a service featuring software for developing, deploying, updating and monitoring the performance of machine learning, deep learning and artificial intelligence applications.) (526): None (730): AMAZON TECHNOLOGIES, INC., a Nevada Corporation of 410 Terry Avenue North, Seattle, Washington 98109, United States of America (740): CFL Advocates of P.O. Box 23555 - 00100, Nairobi, Kenya

(210): 125854 (220): 03/01/2023

AMAZON NEPTUNE

(300): None (511): 9(Computer software for graph database management; computer software for graph database development; computer software for querying graph databases; computer software for compressing, storing and retrieving graph data; computer software for graph data processing and analytics; business intelligence software; computer software development tools.), 35(Graph database management services; graph data processing services; analysis of business data in graphs; providing business intelligence services.) and 42(Software as a service featuring software for graph database management; software as a service featuring software for graph database development; software as a service featuring software for querying graph databases; software as a service featuring software for compressing, storing and retrieving graph data; software as a service featuring software for graph data processing, analytics and visualization; software as a service featuring business intelligence software; software as a service featuring software development tools; database design and development; electronic data storage; computer services, namely, cloud hosting provider services.) (526): None (730): AMAZON TECHNOLOGIES, INC., a Nevada Corporation of 410 Terry Avenue North, Seattle, Washington 98109, United States of America (740): CFL Advocates of P.O. Box 23555 - 00100, Nairobi, Kenya

(210): 125858 (220): 03/01/2023

KENDRA

(300): None (511): 42(Software as a service (SaaS) featuring software for natural language processing; Software as a service (SaaS) featuring software for natural language understanding; Software as a service (SaaS) featuring software for semantic analysis; Software as a service (SaaS) featuring software for machine translation; Software as a service (SaaS) featuring software for data processing; Software as a service (SaaS) featuring software for processing text files; Software as a service (SaaS) featuring software that uses machine learning and natural language algorithms to search structured and unstructured data; Software as a service (SaaS) featuring software for the searching, profiling, classifying, extracting, collection, editing, organizing, modifying, transmission, storage, and sharing of data and information; Software as a service (SaaS) featuring software for employees to search for and locate data and information stored in corporate and organizational data sources; Software as a service (SaaS) featuring software for use in responding to customer inquiries and communicating with others; Software as a service (SaaS) featuring software for generating automated content; Software as a service (SaaS) featuring text recognition, machine learning, and artificial intelligence software for use in automated customer support; Software as a service (SaaS) featuring software for use as an application programming interface; application service provider featuring application programming interface (api) software for the integration of machine learning,

artificial intelligence, and natural language processing into web sites and online software; Rental of computer software.) (526): None (730): AMAZON TECHNOLOGIES, INC., a Nevada Corporation of 410 Terry Avenue North, Seattle, Washington 98109, United States of America (740): CFL Advocates of P.O. Box 23555 - 00100, Nairobi, Kenya

(210): 125860 (220): 03/01/2023

(300): None (511): 9(Computer hardware and software; downloadable digital media; computer software for accessing, managing, processing, storing, streaming and analyzing data, digital media and software applications; computer software development tools; software for accessing, archiving, retrieving and backing up data, digital media and software applications; computer software for allowing users to access, query and analyze information stored in databases and data warehouses; software for cloud computing infrastructure and services; none of the aforesaid goods relating to fluid technology, gas technology and lubricating technology installations and components.), 38(Telecommunications services; providing access to databases; providing multiple-user access to data, digital media and software applications on the Internet; providing access to remotely hosted computer applications through the Internet; transmission of database information via telecommunications networks; streaming of data, digital media and software applications on the Internet; electronic transmission of data, digital media and software applications for others; providing online access to data, digital media and computer software applications; providing online access to cloud storage and infrastructure for data, digital media and software applications.) and 42(Design and development of computer hardware; design and development of computer software; providing temporary use of non-downloadable software; software as a service (SAAS) services; application service provider (ASP) services; providing temporary use of non-downloadable software for accessing, managing, processing, storing, streaming and analyzing data, digital media and software applications; software as a service (SAAS) services featuring software for accessing, managing, processing, storing, streaming and analyzing data, digital media and software applications; application service provider (ASP) services featuring applications for accessing, managing, processing, storing, streaming and analyzing data, digital media and software applications; hosting, managing, provisioning, scaling, administering, maintaining, monitoring and backing up databases and computing environments for others; cloud hosting of electronic databases and computing environments; cloud computing services; cloud computing featuring software for use in database management and data streaming; providing a website featuring non-downloadable software for accessing, managing, processing, storing, streaming and analyzing data, digital media and software applications; computer services, namely, providing variable computing, storage and streaming capacity to others; shared computing capacity scaling services; Electronic storage of data; rental of computing and data storage facilities of variable capacity to third parties; cloud data storage services; electronic storage of data, digital media and software applications; providing temporary use of non-downloadable software for electronic storage of data, digital media and software applications; providing a website for the electronic storage of images, text, audio and video; none of the aforesaid services relating to fluid technology, gas technology and lubricating technology installations and components.) (526): None (730): AMAZON TECHNOLOGIES, INC., a Nevada Corporation of 410 Terry Avenue North, Seattle, Washington 98109, United States of America (740): CFL Advocates of P.O. Box 23555 - 00100, Nairobi, Kenya

AMAZON KINESIS

(210): 125861 (220): 03/01/2023

AMAZON LIGHTSAIL

(300): None (511): 9(Computer software for storage and delivery of text, audio, visual, software and media content; Computer software for the transmission and display of text, visual and audio files; Computer software for hosting, managing, developing and maintaining applications, software, websites, and/or electronic databases of others; Computer software for providing access to a global communications network or other computer or communications networks; Computer software platforms for cloud computing networks and applications; Computer software for data storage; Computer software development tools; Computer hardware and software systems for website and/or mobile application development, functionality, and hosting, data storage and accessibility, and website or mobile application management, through cloud computing; Computer programs, namely, programs for creating, posting and maintaining web sites on the global computer network.), 38(Providing access to databases; Providing multiple-user access to data on the Internet in the field of cloud computing; Providing temporary access to remote computers for the purpose of running software programs; Internet services, namely, providing multiple-user access to information on the internet concerning the development and generation of computer software for use in businesses as well as the functions and application of such business software; Providing access to telecommunications networks, namely, providing access to remotely hosted operating systems and computer applications through the Internet; Providing on-line chat rooms, bulletin boards and community forums for the transmission of messages in the fields of cloud computing, website or mobile application development, data management, and/or hosting.) and 42(Computer services, namely, cloud hosting provider services; Computer services, namely, acting as an application services provider for other featuring secure remote hosting of operating systems and computer applications; Computer services in the nature of providing a secure virtual computing environment accessible via the Internet for authenticated users, namely, hosting the software and computer applications of others on a virtual private server for secure access by authenticated users; Computer services, namely, providing database servers of variable capacity to others; Computer services, namely, monitoring and reporting on the performance, availability, and errors of databases of others; Electronic data storage; Rental of computing and data storage facilities of variable capacity to third parties, namely, rental of web servers and rental of database servers within a cloud infrastructure; Providing online use of non-downloadable software for managing computer applications, operating systems and databases; Software as a service (SAAS) services featuring software for mobile application software development, website development, management of hardware resources, and/or database management; Remote online backup of computer data; Providing database backup computer programs and facilities; Providing temporary use of on-line non-downloadable cloud computing software for development and generation of computer software for use in businesses as well as the functions and application of such business software; Application service provider, namely, hosting, managing, developing, and maintaining applications, software, and web sites, in the fields of personal productivity, wireless communication, mobile information access, and remote data management for wireless delivery of content to handheld computers, laptops and mobile electronic devices; Hosting the software, web sites and other computer applications of others using private servers and cloud hosting services; Dedicated IP address hosting for others; DNS services for others; Technological services, namely, hosting, managing, provisioning, scaling,

administering, maintaining, monitoring, securing, encrypting, decrypting, replicating and backing up databases for others; Technological services, namely, software as a service (SAAS) services featuring software for use in database management, data access, data extraction and reporting and query functionality for management of data; Technological services, namely, cloud computing featuring software for use in database management and data warehousing; Technological services, namely, cloud hosting of electronic databases; Technological services, namely, providing database servers of variable capacity to others; Technological services, namely, rental of computing and data storage facilities of variable capacity to third parties; Technological services, namely, data encryption and decoding services; Technological services, namely, management of on-line databases for others; Technological services, namely, providing access to databases; Technological services, namely, electronic data transmission; Technological services, namely, providing access to remotely hosted computer applications through the Internet; Technological services, namely, computer security services in the nature of maintaining security and integrity of databases and digital information.) (526): None (730): AMAZON TECHNOLOGIES, INC., a Nevada Corporation of 410 Terry Avenue North, Seattle, Washington 98109, United States of America (740): CFL Advocates of P.O. Box 23555 - 00100, Nairobi, Kenya

(210): 125863 (220): 03/01/2023

FARGATE

(300): None (511): 9(Downloadable cloud-computing software for software development and deployment; Computer software for analyzing and managing server space usage and capacity; Computer software for use in management of data on cloud-based servers; Computer software for management of data containers; Computer software for optimization of cluster space usage; Computer software for managing software application deployments, managing load balancing, performing health checks, service discovery, and scaling based on usage.), 35(Business data analysis; Data processing services; Database management services; Updating and maintenance of data in computer databases; Management of on-line databases for others.) and 42(Software-as-a-service (SaaS) featuring software for cloud computing; Software-as-a-service (SaaS) featuring software for developing cloud-based software applications and programs; Software-as-a-service (SaaS) featuring software for management of server capacity and usage; Software-as-a-service (SaaS) featuring software for management of clusters and server space; Software-as-a-service (SaaS) featuring software for data management; Software-as-a-service (SaaS) featuring software for management of data containers; Software-as-a-service (SaaS) featuring software for management of data containers and data clusters based on usage; Software-as-a-service (SaaS) featuring software for managing software application deployments, managing load balancing, performing health checks, service discovery, and scaling based on usage; Platform-as-a-service (paaS) for cloud computing; Platform-as-a-service (paaS) featuring cloud-based data servers, software development tools, software for data management, software for cluster management, software for management of server capacity and usage, and software for managing software application deployments, managing load balancing, performing health checks, service discovery, and scaling based on usage; Consulting in the field of information technology and cloud computing; Technical support services, namely, infrastructure management services for image containers or data containers; Platform-as-a-service (paaS), Infrastructure-as-a-service (IaaS) and Software-as-a-service (SaaS) services featuring computer software for analyzing and managing data or containers containing data on servers; Electronic data storage services in the nature of technical management of data

clusters.) (526): None (730): AMAZON TECHNOLOGIES, INC., a Nevada Corporation of 410 Terry Avenue North, Seattle, Washington 98109, United States of America (740): CFL Advocates of P.O. Box 23555 - 00100, Nairobi, Kenya

(210): 125864 (220): 03/01/2023

(300): None (511): 9(Computer software for searching, locating, compiling, indexing, correlating, navigating, obtaining, downloading, receiving, encoding, decoding, playing, storing and organizing text, data, images, graphics, audio and video on a global computer network; downloadable application software for wireless delivery of content, text, data, images to electronic devices.), 35(Online management of databases.), 38(Providing access to databases.), 42(Design and development of computer software for searching, locating, compiling, indexing, correlating, navigating, obtaining, downloading, receiving, encoding, decoding, playing, storing and organizing text, data, images, graphics, audio and video on a global computer network; Electronic storage services for archiving databases, images and other electronic data.) and 45(Computer security services in the nature of maintaining security and integrity of databases and digital information.) (526): None (730): AMAZON TECHNOLOGIES, INC., a Nevada Corporation of 410 Terry Avenue North, Seattle, Washington 98109, United States of America (740): CFL Advocates of P.O. Box 23555 - 00100, Nairobi, Kenya

GLACIER

(210): 125865 (220): 03/01/2023

(300): None (511): 9(Downloadable computer software for creating and managing spreadsheets; downloadable computer software for managing data; downloadable computer software for building native mobile applications; downloadable computer software for creating, managing, and automating business processes; downloadable computer software for the collection, editing, organizing, modifying, transmission, storage, and sharing of data and information; downloadable computer software for database management; downloadable computer software for application and database integration; downloadable computer software for workflow management; downloadable computer software for project anagement; downloadable computer software development tools; downloadable computer operating software.) and 42(Provision of cloud-based computer software for creating and managing spreadsheets; provision of cloud-based computer software for managing data; provision of cloud-based computer software for building mobile applications; provision of cloud-based computer software for creating, managing and automating business processes; provision of cloud-based computer software platform that allows users to build mobile applications and manage data; provision of cloud-based computer software for the collection, editing, organizing, modifying, transmission, storage, and sharing of data and information; providing temporary use of a web-based software application for use in database management, use as a spreadsheet, project management, and storage of data; providing temporary use of on-line non-downloadable cloud computing software for use in database management, use as a spreadsheet, project management, and storage of data; platform-as-a-service (paaS) featuring cloud-based data servers, software development tools, software for data management, software for building native mobile applications, software for database management, software for application and database integration; provision of software for management of server capacity and usage, and software for managing software application deployments, managing load balancing, erforming health checks, service discovery, and scaling based on usage; software-as-a-service (SaaS) services featuring computer software for analyzing and managing data on servers; provision of cloud-based computer

HONEYCODE

software for database management; provision of cloud-based computer software for application and database integration; provision of cloud-based computer software for workflow management; provision of cloud-based computer software for project management; provision of cloud-based computer software development tools; provision of cloud-based computer software and software-as-a-service (SaaS) services.) (526): None (730): AMAZON TECHNOLOGIES, INC., a Nevada Corporation of 410 Terry Avenue North, Seattle, Washington 98109, United States of America (740): CFL Advocates of P.O. Box 23555 - 00100, Nairobi, Kenya

(210): 125866 (220): 03/01/2023

SITewise

(300): None (511): 9(Downloadable computer software for developers to collect, manage, store, organize, process, analyze, sample, filter, aggregate, transform, and monitor equipment data on premises; Downloadable computer software for developers to collect, manage, store, organize, process, analyze, sample, filter, aggregate, transform, and monitor industrial data; Downloadable computer software for collecting on-premises equipment data and creating virtual representations of facilities and physical assets; Downloadable computer software for storing data in -, a time series database, running queries, and streaming structured internet-of-things (IoT) data to access asset information; Downloadable computer software for creating fully managed web applications to visualize real-time and historical equipment data, with no coding; Downloadable computer software for compiling asset data to create custom applications that optimize factory output quality, maximize asset utilization, and identify equipment maintenance issues; Downloadable computer software for local use of cloud-based software, application programming interfaces (APIs), and data during times without connectivity to the cloud or the Internet; Downloadable computer software for migrating software or data into the cloud and locally to enable continued local operation using the software or data whether or not connectivity to the cloud exists; Downloadable computer software for the management of local computer resources and cloud-based resources to comply with regulatory, compliance, or privacy requirements for the local storage of data or software; Downloadable computer software for use in computer data storage, messaging, and computer device management; Downloadable computer software for enabling electronic devices to operate and communicate locally while retaining the benefits of analytics and high-level services in the cloud; Downloadable computer software for the collection, editing, organizing, modifying, book marking, transmission, storage, and sharing of data and information), 35(Technological services, namely, data processing services.), 38(Technological services, namely, providing user access to computer programs in data networks; Technological services, namely, electronic data transmission; Providing access to databases.) and 42(Software as a service (SaaS) services featuring software for collecting, storing, managing, storing, organizing, processing, analyzing, sampling, filtering, aggregating, transforming, and monitoring data from industrial equipment on premises; Software as a service (SaaS) services featuring software for monitoring operations across facilities, computing common industrial performance metrics, and creating applications that analyze industrial equipment data to prevent equipment issues and reduce gaps in production; Software as a service (SaaS) services featuring software for creating models of industrial processes and equipment across facilities, and visualizing live and historical asset data through customizable charts and dashboards; Cloud computing featuring software for the management of local computer resources and cloud-based resources

to optimize operations; Cloud computing featuring software for the management of local computer resources and cloud-based resources to comply with regulatory, compliance, or privacy requirements for the local storage of data or software; Cloud computing featuring software for enabling electronic devices to operate and communicate locally while retaining the benefits of analytics and high-level services in the cloud; Cloud computing featuring software for analyzing software and data use needs and determining which software and data to locally store and which software and data to store on cloud-based devices; Software as a Service (SaaS) services featuring software for local use of cloud-based software, application programming interfaces (APIs), and data during times without connectivity to the cloud; Software as a Service (SaaS) services featuring software for management of local computer resources and cloud-based resources to comply with regulatory, compliance, or privacy requirements for the local storage of data or software; Software as a Service (SaaS) services featuring software for computer data storage, messaging and computer device management; Software as a Service (SaaS) services featuring software for analyzing software and data use needs and determining which software and data to locally store and which software and data to store on cloud-based devices; Software as a Service (SaaS) services featuring web-based software for collecting, storing, organizing, processing, analyzing, and monitoring real-time data; Technological services, namely, management of information technology systems of others consisting of local computer resources and cloud-based resources; Technological services, namely, configuring computer-based information systems comprised of local and cloud-based resources in order to optimize business operations of others; Technological services, namely, computer analysis of local and cloud-based resources to determine strategies to comply with regulatory, compliance, or privacy requirements for the local storage of data or software for limited accessibility; Technological services, namely, analyzing software and data use needs and determining which software and data to locally store and which software and data to store on cloud-based devices; Technological services, namely, electronic data storage; Monitoring of computer systems by remote access to ensure proper functioning.) (526): None (730): AMAZON TECHNOLOGIES, INC., a Nevada Corporation of 410 Terry Avenue North, Seattle, Washington 98109, United States of America (740): CFL Advocates of P.O. Box 23555 - 00100, Nairobi, Kenya

(210): 125867 (220): 03/01/2023

(300): None (511): 9(Scientific, nautical, surveying, photographic, cinematographic, optical, weighing, measuring, signalling, checking (supervision) apparatus and instruments, apparatus and instruments for conducting, switching, transforming, accumulating, regulating or controlling electricity; apparatus for recording, transmission or reproduction of sound or images; magnetic data carriers, recording discs; compact discs, DVDs and other digital recording media; mechanisms for coin-operated apparatus; cash registers, calculating machines, data processing equipment, computers; computer software; computer operating systems; downloadable software for accessing and managing of computer applications over a global computer network; computer software, recorded, for Internet applications; application software for Internet solutions; computer interface software in the field of Internet applications; computer software for the collection, editing, organizing, modifying, book marking, transmission, storage and sharing of data and information; computer software for use in authoring, downloading, transmitting, receiving, editing, extracting, encoding, decoding, playing, storing and organizing text, data, images, audio files in connection with

SNOWBALL

computers, music players, video players, media players, cellular phones, and portable and handheld digital electronic devices; computer application software for use with computer hardware and mobile devices; software for creating searchable databases; software for wireless content delivery; software for accessing information on the Internet or other computer or communications network; software for transmitting, receiving, downloading, streaming, and displaying content, text, visual works, audiovisual works, data, files and electronic works via the Internet or other computer or communications network; software for formatting and converting content, text, visual works, audiovisual works, data, files and electronic works into a format compatible with portable electronic devices and computers; software enabling content, text, visual works, audiovisual works, data, files and electronic works to be downloaded to and accessed on a computer or other portable consumer electronic device; computer software for identifying, locating, grouping, distributing, and managing data and links between computer servers and users connected to electronic communications networks; apparatus for recording, transmissions, processing or reproduction of data, including sound or images, including parts for all the aforesaid goods; scientific, electric and electronic apparatus and instruments, all for the receiving, processing, transmitting, storing or relaying input or output of data; downloadable electronic content; computer software platforms.), 38(Telecommunications; electronic delivery, transmission, caching, sharing and streaming of documents, data, text, images and other visual works, software, files, hypertext markup language source, web pages, information, documents, music and other audio works, and video and other audiovisual works vta a global communications network or other computer or communications networks; telecommunications gateway services; providing multiple user access to a global communications network or other computer or communications network; communications by electronic computer terminals enabling users to locate, upload, post, show, display, share, store, transmit or otherwise provide data, text, images and other visual works, software, hypertext markup language source, information, documents, music and other audio works, and video and other audiovisual works; peer-to-peer network computer services, namely, electronic transmission of data, text, images and other visual works, software, files, hypertext markup language source, web pages, information, documents, music and other audio works, and video and other audiovisual works among computers; providing access to hosted operating systems and computer applications through a global computer network or other computer or communications network; providing information, consultancy and advisory services related to all of the foregoing services.), 39(Transport; packaging and storage of goods; travel arrangement; expedited shipping service; physical storage of electronically-stored data or documents.) and 42(Scientific and technological services and research and design relating thereto; industrial analysis and research; research, design and development of computer hardware and software; consultancy relating to the research, design and development of computer hardware and software; computer programming; operating and maintenance of computer software; rental of computer hardware and software; computer time-sharing services; installation and maintenance of online access software; computerized data storage; design of storage systems; electronic data storage and data back-up services; development of systems for the storage of data; provision of security services for computer networks, computer access and computerized transactions; cloud computing and seeding; computerized analysis of data; creating and maintaining Web sites featuring technology that enables users to

access stored data, images, audio, video and documents; hosting Website of others featuring technology that enables users to access stored data, images, audio, videos, and documents; providing search engines for obtaining data via communications networks; creating indexes of computer network-based information, sites, and other resources available on global computer networks for others; technical data analysis services; computer system analysis; electronic data storage; storing of documents, data, text, images and other visual works, software, files, hypertext markup language source, web pages, information, documents, music and other audio works, and video and other audiovisual works via a global communications network or other computer or communications networks; electronic storage of data, text, images, audio and video.)

(526): None (730): AMAZON TECHNOLOGIES, INC., a Nevada Corporation of 410 Terry Avenue North, Seattle, Washington 98109, United States of America (740): CFL Advocates of P.O. Box 23555 - 00100, Nairobi, Kenya

(210): 125868 (220): 03/01/2023

(300): None (511): 9(Computer hardware for training machine learning models across applications; Computer hardware for training and accelerating machine learning models for image recognition, natural language processing, speech recognition, translation, personalization, fraud detection, forecasting, autonomous vehicles, and recommendation engines; Computer hardware for machine learning acceleration across applications; Computer hardware specifically designed to facilitate the delivery of cloud computing services, namely, semiconductors, computer chips, integrated circuits, central processing units, electronic circuits and microprocessors; computer chips; computer central processing units; circuit boards; electronic circuit cards; integrated circuit modules; downloadable computer software for use in the operation of semiconductors, computer chips, and central processing units; downloadable computer software development tools; downloadable computer software for developing computer hardware; downloadable computer firmware and software for use in the operation of semiconductors, computer chips, and central processing units; downloadable computer software used for advanced cloud computing functions in the nature of machine learning, optimizing power, performance and cost for cloud computing services, and delivering cloud computing services at scale; computer hardware used for advanced cloud computing functions in the nature of machine learning, optimizing power, performance and cost for cloud computing services, and delivering cloud computing services at scale; downloadable computer software for operation, management and control of computer chips, central processing units and microprocessors.), 40(Custom manufacture of computer hardware, including semiconductors, computer chips, integrated circuits, and central processing units; manufacturing electric and electronic components for others.) and 42(Providing temporary use of on-line non-downloadable cloud computing software for use with operating and running computer hardware for accelerating machine learning; Providing temporary use of on-line non-downloadable cloud computing software for training machine learning models across applications; Providing temporary use of on-line non-downloadable cloud computing software for use with operating and running computer hardware for training and accelerating machine learning models for image recognition, natural language processing, speech recognition, translation, personalization, fraud detection, forecasting, autonomous vehicles, and recommendation engines; Computer hardware engineering services; design of semiconductors, integrated circuits, computer chips and central processing units for others; Providing temporary use of non-downloadable cloud

TRAINIUM

computing software for use with operating and running computer hardware for machine learning, optimizing power, performance and cost for cloud computing services, and delivering cloud computing services at scale.) **(526)**: None **(730)**: AMAZON TECHNOLOGIES, INC., a Nevada Corporation of 410 Terry Avenue North, Seattle, Washington 98109, United States of America **(740)**: CFL Advocates of P.O. Box 23555 - 00100, Nairobi, Kenya

(210): 125869 **(220)**: 03/01/2023

WAVELENGHT

(300): None **(511)**: 9(Recorded or downloadable software for accessing and managing low-latency cloud computing resources; recorded or downloadable software for accessing and managing cloud computing infrastructure; recorded or downloadable software for accessing and managing wireless, mobile, and edge communications infrastructure and networks; recorded or downloadable software for running cloud computing based applications; recorded or downloadable software for running distributed network based applications; recorded or downloadable software for managing distributed computer networks and resources; recorded or downloadable software for data processing and data transmission; recorded or downloadable software development and deployment tools.), 38(Providing access to low-latency cloud computing resources and infrastructure on telecommunications networks; providing access to telecommunications networks; electronic data transmission.) and 42(Computer services, namely, cloud hosting provider services; providing virtual computer systems and virtual computer environments through cloud computing; computer services, namely, providing virtual servers of variable capacity to others; scaling services, namely, providing variable computing and electronic data storage capacity to others; administering and maintaining virtual computing environments for others; electronic data storage; computer software rental; planning, design and implementation of computer technologies for others; deployment and management of wireless computer networks for others; software as a service (SAAS) services featuring software for accessing and managing low-latency cloud computing resources; software as a service (SAAS) services featuring software for accessing and managing cloud computing infrastructure; software as a service (SAAS) services featuring software for accessing and managing wireless, mobile, and edge communications infrastructure and networks; software as a service (SAAS) services featuring software for running cloud computing based applications; software as a service (SAAS) services featuring software for running distributed network based applications; software as a service. (SAAS) services featuring software for managing distributed computer networks and resources; software as a service (SAAS) services featuring software for data processing and data transmission; software as a service (SAAS) services featuring software development and deployment tools.) **(526)**: None **(730)**: AMAZON TECHNOLOGIES, INC., a Nevada Corporation of 410 Terry Avenue North, Seattle, Washington 98109, United States of America **(740)**: CFL Advocates of P.O. Box 23555 - 00100, Nairobi, Kenya

(210): 125870 **(220)**: 03/01/2023

SNOWCONE

(300): None **(511)**: 9(Computer software platforms, recorded or downloadable; computer software, recorded; computer software applications, downloadable; computer programs (downloadable software);Data processing equipment and computers; computer software for data migration and/or transfer; computer software for electronic data migrations/transfers and/ or monitoring the status of electronic data migrations/transfers; computer application software for use with computer hardware and mobile devices for managing data storage, data migration and/or data transfer; software for creating searchable databases; software for accessing cloud-stored

information or data on the internet or other computer or communications networks; computer software for identifying, locating, grouping, distributing, and managing data and links between computer servers and users connected to electronic communications networks; portable devices containing hard drives, software, and connection ports, for receiving, recording, storing, transmitting, processing or reproducing data; electronic data processing apparatus.), 38(Electronic transmission and streaming of documents, data, text, images and other visual works, software, files, hypertext markup language source, web pages, information, documents, music and other audio works, and video and other audiovisual works via a global communications network or other computer or communications networks; telecommunications gateway services; providing multiple user access to a global communications network or other computer or communications network; communications by electronic computer terminals enabling users to locate, upload, post, show, display, share, store, transmit or otherwise provide data, text, images and other visual works, software, hypertext markup language source, information, documents, music and other audio works, and video and other audiovisual works; peer-to-peer network computer services, namely, electronic transmission of data, text, images and other visual works, software, files, hypertext markup language source, web pages, information, documents, music and other audio works, and video and other audiovisual works among computers; providing user access to computer programs in data networks; providing multiple user access to proprietary collections of information by means of global computer information networks; providing access to databases; providing information, consultancy and advisory services related to all of the foregoing services.), 39(Transport by automobile of electronic data storage hardware and software from one location to another; storage, transport, and delivery of goods, namely, electronic data storage hardware; transportation consulting services; transport of goods, namely, transport of storage devices containing electronic data from an onsite location to an offsite location; packaging and storage of goods; expedited shipping services for electronic data stored on a transportable hardware device; physical storage of electronically-stored data or documents.) and 42(Data warehousing services; application service provider, namely, hosting, managing, administering, maintaining, monitoring encrypting, decrypting, replicating and backing up electronic databases for others; Software as a service (saas) services featuring software for use in database migration and/or transfer; software as a service (saas) services featuring software for electronic data migrations/transfers and/or monitoring the status of electronic data migrations/transfers; software as a service (saas) services featuring software for use with computer hardware and mobile devices for managing data storage, data migration and/or data transfer; software as a service (saas) services featuring software for creating searchable databases; software as a service (saas) services featuring software for accessing cloud-stored information or data on the internet or other computer or communications networks; software as a service (saas) services featuring software for identifying, locating, grouping, distributing, and managing data and links between computer servers and users connected to electronic communications networks; electronic data storage; rental of electronic data storage devices to third parties; data encryption and decoding services; computer security services in the nature of maintaining security and integrity of databases and digital information; consultancy relating to the research, design and development of computer hardware and software; rental of computer hardware and software; computer time-sharing services; installation and maintenance of online access

software; computerized electronic data storage; design of electronic data storage systems; off-site data back-up services; backup services for computer hard drive data; development of computer systems for the storage of data; computer security services, namely, enforcing, restricting and controlling access privileges of users of computing resources for cloud, mobile or network resources based on assigned credentials; consulting services in the field of cloud computing; cloud computing featuring software for data migration and storage; computer services, namely, cloud hosting provider services; cloud seeding; providing a cloud computing website featuring technology that enables users to access stored data, images, audio, video and documents; providing temporary use of online non downloadable computer applications for data storage and access; hosting website of others featuring technology that enables users to access stored data, images, audio, videos, and documents; providing search engines for obtaining data via communications networks; creating indexes of computer network-based information, sites, and other resources available on global computer networks for others; technical data analysis services, namely, data migration consulting services in the nature of creating data migration/ transfer plans and/or performing data migrations/transfers using electronic storage hardware and software; technical data analysis services, namely, data migration consulting services in the nature of copying/ migration/ transfer and/or uploading of electronic data to a cloud-based electronic data storage system; technical support services, namely, data migration consulting services in the nature of migration of datacenter, server and database applications; computer system analysis; electronic data storage; electronic data storage, namely, storing of documents, data, text, images and other visual works, software, files, hypertext markup language source, web pages, information, documents, music and other audio works, and video and other audiovisual works via a global communications network or other computer or communications networks; electronic storage of data, text, images, audio and video; computer technology consultancy; cloud computing; computer rental; monitoring of computer systems by remote access; software as a service (SaaS). (526): None (730): AMAZON TECHNOLOGIES, INC., a Nevada Corporation of 410 Terry Avenue North, Seattle, Washington 98109, United States of America (740): CFL Advocates of P.O. Box 23555 - 00100, Nairobi, Kenya

(210): 125871 (220): 03/01/2023

(300): None (511): 9(Scientific, nautical, surveying, photographic, cinematographic, optical, weighing, measuring, signaling, checking (Supervision), life-saving and teaching apparatus and instruments; apparatus and instruments for conducting, switching, transforming, accumulating, regulating or controlling electricity; apparatus for recording, transmission or reproduction of sound or images; magnetic data carriers, recording discs; compact discs, DVDs and other digital recording media; mechanisms for coin-operated apparatus; cash registers, calculating machines, data processing equipment, computers; computer software; fire-extinguishing apparatus.), 35(Advertising; business management; business administration; office functions; storage of text, images and other visual works, software, files, hypertext markup language source, web pages, information, documents, music and other audio works, and video and other audiovisual works, data storage, computerized data storage and retrieval, electronic storage of files and documents related to a broad range of consumer products; on-line retail services featuring computer software, internet browser software, web browser software for mobile communications devices, computer software to enhance mobile access to the internet via computers, mobile computers, and mobile communications devices, computer

AMAZON REDSHIFT

and mobile device software used to enhance mobile access to web and internet applications via computers, mobile computers, and mobile communications devices, computer software for use in operating mobile computers and mobile communications devices, computer and mobile device software for enhancing uploading and downloading capabilities on computers, mobile computers, and mobile communications devices, computer and mobile device software used to enhance the use of application launchers, widgets, and online mobile device applications stores, portable and handheld electronic devices for transmitting, storing, manipulating, recording, and reviewing text, images, audio, video and data, including via global computer networks, wireless networks, and electronic communications networks, computers, tablet computers, electronic book readers, audio and video players, electronic personal organizers, personal digital assistants, and global positioning system devices and electronic and mechanical parts and fittings therefore.), 39(Physical storage of electronic media, namely, images, text, video, and audio data.) and 42(Scientific and technological services and research and design relating thereto; industrial analysis and research services; design and development of computer hardware and software.) (526): None (730): AMAZON TECHNOLOGIES, INC., a Nevada Corporation of 410 Terry Avenue North, Seattle, Washington 98109, United States of America (740): CFL Advocates of P.O. Box 23555 - 00100, Nairobi, Kenya

(210): 125876 (220): 03/01/2023

AMAZON GAMELIFT

(300): None (511): 42(Design and development of operating software for accessing and using a cloud computing network in relation to multiplayer computer games; development of multiplayer online gaming software available via an online cloud; Website hosting services for hosting multiplayer computer games via an online cloud network; Creating web sites for hosting multiplayer computer games via an online cloud network; Hosting of web sites for hosting multiplayer computer games via an online cloud network; all the aforementioned services excluding the development and publication of video games.) (526): None (730): AMAZON TECHNOLOGIES, INC., a Nevada Corporation of 410 Terry Avenue North, Seattle, Washington 98109, United States of America (740): CFL Advocates of P.O. Box 23555 - 00100, Nairobi, Kenya

(210): 125887 (220): 04/01/2023

(300): None (511): 30(Coffee and substitutes thereof; tea and tea-based preparations; cocoa and cocoa preparations; tapioca and sago, flour and preparations made from cereals; bread, pastries and confectionery; chocolate; ice cream, sorbets and other edible ices; sugar, honey, treacle; yeast, baking-powder; salt, seasonings, spices, preserved herbs; vinegar, sauces and other condiments; ice frozen water.) (526): Registration of this mark shall give no right to the exclusive use of the device of "grains" and the letter "I" per se each separately and apart from the mark as a whole. "FASIHI" is a Kiswahili word which means "Literature" in English. (730): SANIFU GOURMET of P.O. Box 56483, Nairobi, Kenya (740): None



(210): 125888 (220): 04/01/2023

(300): None (511): 30(Com/maize meal, flour and based preparations thereof; rice, pasta and noodles; tapioca and sago; flour and preparations made from cereals; bread, pastries and confectionery; chocolate; ice cream, sorbets and other edible ices; sugar, honey, treacle; yeast, baking-powder; salt, seasonings, spices, preserved herbs; vinegar, sauces and other flavorings and condiments; ice) (526): "Makhal" is a coined term with no known meaning. (730): GRAND GRAINS LIMITED of P.O. Box 56843, Nairobi, Kenya (740): None



(210): 125890 **(220):** 04/01/2023
(300): None **(511):** 16(Paper, cardboard and goods made from these materials, not included in other classes; printed matter; bookbinding material; photographs; stationery; adhesives for stationery or household purposes; artists' materials; paint brushes; typewriters and office requisites (except furniture); instructional and teaching material (except apparatus); plastic materials for packaging (not included in other classes); printers' type; printing block) and 45(Personal and social services rendered by others to meet the needs of individuals; security services for the protection of property and individuals.) **(526):** Registration of this mark shall give no right the exclusive use of the word "Fund", "Secured" and "Retirement" and the letters "A", "L" and "P" each separately and apart from the mark as a whole. **(730):** LOCAL AUTHORITIES PROVIDENT FUND BOARD of 316 Upperhill Chambers Limited, 2nd Ngong Avenue, 10th Floor, P.O. Box 79592 - 00200, Nairobi, Kenya **(740):** None



(210): 125890 **(220):** 04/01/2023
(300): None **(511):** 16(Paper, cardboard and goods made from these materials, not included in other classes; printed matter; bookbinding material; photographs; stationery; adhesives for stationery or household purposes; artists' materials; paint brushes; typewriters and office requisites (except furniture); instructional and teaching material (except apparatus); plastic materials for packaging (not included in other classes); printers' type; printing block) and 45(Personal and social services rendered by others to meet the needs of individuals; security services for the protection of property and individuals.) **(526):** Registration of this mark shall give no right the exclusive use of the word "Fund", "Secured" and "Retirement" and the letters "A", "L" and "P" each separately and apart from the mark as a whole. **(730):** LOCAL AUTHORITIES PROVIDENT FUND BOARD of 316 Upperhill Chambers Limited, 2nd Ngong Avenue, 10th Floor, P.O. Box 79592 - 00200, Nairobi, Kenya **(740):** None



(210): 125898 **(220):** 05/01/2023
(300): None **(511):** 6(Profiling of Iron Sheets.) **(526):** Registration of this mark shall give no right to the exclusive use of the word "VERSATILE" separately and apart from the mark as a whole. **(730):** EAGLE 1 CONCRETE & MACHINERIES LTD of P.O. Box 43449 - 00100, Nairobi, Kenya **(740):** None

EAGLE VERSATILE

(210): 125899 **(220):** 05/01/2023
(300): None **(511):** 6(Profiling of iron sheets.) **(526):** Registration of this mark shall give no right to the exclusive use of the words "ROMAN" and "TILE" each separately and apart from the mark as a whole. **(730):** EAGLE 1 CONCRETE & MACHINERIES LTD of P.O. Box 43449 - 00100, Nairobi, Kenya **(740):** None

EAGLE ROMAN TILE

(210): 125900 **(220):** 05/01/2023
(300): None **(511):** 6(Profiling of iron sheets) **(526):** Registration of this mark shall give no right to the exclusive use of the word 'CORRUGATED' separately and apart from the mark as a whole. **(730):** EAGLE 1 CONCRETE & MACHINERIES LTD of P.O. Box 43449 - 00100, Nairobi, Kenya **(740):** None

EAGLE CORRUGATED

(210): 125901 **(220):** 05/01/2023
(300): None **(511):** 6(Profiling of iron sheets) **(526):** Registration of this mark shall give no right to the exclusive use of the word 'BOX' separately and apart from the mark as a whole. **(730):** EAGLE 1 CONCRETE & MACHINERIES LTD of P.O. Box 43449 - 00100, Nairobi, Kenya **(740):** None

EAGLE BOX

(210): 125904 (220): 05/01/2023

(300): None (511): 9(Mobile App) (526): Registration of this mark shall give no right to the exclusive use of the letters 'a', 'e', 'r' and 'w' each separately and apart from the mark as a whole. The translation into English of the Kikuyu vernacular word 'Wera' is 'Work' (730): MUSAAB ALI HASSAN of P. O. Box 30197 - 00100, Nairobi, Kenya (740): None

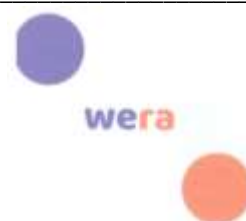

(210): 125905 (220): 05/01/2023

(300): None (511): 30(Food seasonings, namely, salt, pepper and seasoned salt) (526): None (730): SWAHILI COAST SALT COMPANY LIMITED of P. O. Box 343, Chake Chake, United Republic of Tanzania (740): Coulson Harvey Advocates of P.O. Box 10643 - 00100, Nairobi, Kenya

ZALT

(210): 125907 (220): 05/01/2023

(300): None (511): 1(Enzymes to assist in digestion for use in the manufacture of animal feeds; enzymes for use in the manufacture of pet food; enzymes for industrial purposes; chemical preparations for use in the manufacture of pharmaceuticals; chemicals used in industry and science; bacterial preparations other than for medical or veterinary use; enzyme preparations for agricultural purposes; artificial sweeteners for beverages; artificial sweeteners [chemical preparations]; nutrients for yeast for industrial purposes; biomass for producing bio fuels; bacterial preparations for the food industry.) (526): None (730): CJ CHEILJEDANG CORPORATION of CJ Cheiljedang Center, 330, Dongho-ro, Jung-gu, Seoul, Republic of Korea (740): Hamilton Harrison & Mathews Advocates of P. O. Box 30333 - 00100, Nairobi, Kenya

GrowinAct

(210): 125908 (220): 05/01/2023

(300): None (511): 5(Ferments for medical or veterinary use; digestive enzymes for medical or veterinary use; ferments for pharmaceutical purposes; enzyme dietary supplements; dietary supplements for animals; nutritional supplements for animal foodstuffs; preparations of microorganisms for medical or veterinary use; food for babies; powdered milk for babies; vitamin and mineral preparations; feed supplements for veterinary purposes; biological preparations for veterinary purposes.) (526): None (730): CJ CHEILJEDANG CORPORATION of CJ Cheiljedang Center, 330, Dongho-ro, Jung-gu, Seoul, Republic of Korea (740): Hamilton Harrison & Mathews Advocates of P. O. Box 30333 - 00100, Nairobi, Kenya

GrowinAct

(210): 125909 (220): 05/01/2023

(300): None (511): 31(Fodder; feed ingredients for animal consumption; algae, unprocessed, for human or animal consumption; yeast for animal consumption; flavorings for animal feed; formula animal feed;" foodstuffs for farm animals; foodstuffs for poultrv.) (526): None (730): CJ CHEILJEDANG CORPORATION of CJ Cheiljedang Center, 330, Dongho-ro, Jung-gu, Seoul, Republic of Korea (740): Hamilton Harrison & Mathews Advocates of P. O. Box 30333 - 00100, Nairobi, Kenya

GrowinAct

(210): 125911 (220): 06/01/2023

(300): None (511): 42(Scientific and technological services and research and design, industrial analysis and research services, design and development of computer hardware and software) (526): Registration of this mark shall give no right to the exclusive use of the letters 'E', 'I' and 'T' each separately and apart from the mark as a whole. (730): EVOLABS IT SOLUTIONS LTD of P.O. Box 66323 - 00800, Nairobi, Kenya (740): None

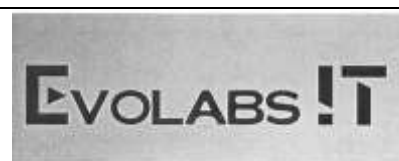

(210): 125912 (220): 06/01/2023

(300): None (511): 42(Scientific and technological services and research and design, industrial analysis and research services, design and development of computer hardware and software) (526): Registration of this mark shall give no right to the exclusive use of the letters 'F', 'W', 'M' and 'S' each separately and apart from the mark as a whole. (730): EVOLABS IT SOLUTIONS LTD of P.O. Box 66323 - 00800, Nairobi, Kenya (740): None



(210): 125913 (220): 06/01/2023

(300): None (511): 5(Pharmaceuticals) (526): None (730): GLOBE PHARMACY LIMITED of P.O. Box 58171 - 00200, Nairobi, Kenya (740): None

ARIPROCT

(210): 125916 (220): 06/01/2023

(300): None (511): 29(Milk) (526): Registration of this mark shall give no right to the exclusive use of the words 'KAJIADO', 'FRESH', 'WHOLE MILK' and device of a 'gourd' each separately and apart from the mark as a whole. (730): MWAMBA OIBOR DAIRY LTD of P.O. Box 76327 - 00508, Nairobi, Kenya (740): None



(210): 125918 (220): 06/01/2023

(300): None (511): 36(Insurances, financial affairs; monetary affairs; and real estate affairs.) (526): None (730): CREDITAREA CAPITAL LIMITED of Spectrum Business Park, Godown No.3, Baba Dogo, P.O. Box 7460 - 00600, Nairobi, Kenya (740): CAROLINE NDUTA WANGECHI of P. O. Box 8611 - 00360, Nairobi, Kenya



(210): 125923 (220): 06/01/2023

(300): None (511): 34(Tobacco and tobacco substitutes; cigarettes and cigars; electronic cigarettes and oral vaporizers for smokers; smokers' articles; matches.) and 35(Advertising; business management, organization and administration; office functions) (526): Registration of this mark shall give no right to the exclusive use of the letter 'M' separately and apart from the mark as a whole. 'Fummo' is a slang word derived from the English word 'Fume' (730): FUMMO LTD of P. O. Box 11460 - 00400, Nairobi, Kenya (740): Lumallas, Achieng' & Kavere Advocates of P.O. Box 22568 - 00100, Nairobi, Kenya

FUMMO

(210): 125925 (220): 09/01/2023

(300): None (511): 30(Chocolates, confectionery, candies, biscuits, cakes, pasta, macaroni, noodles, instant noodles, spaghetti, vermicelli, yeast, baking powder and other bakery ingredients, salad dressings, mayonnaise, vinegar, ketchup and sauces(condiments), ready to cook dough products, frozen dough, frozen parathas, ice creams, non-dairy frozen desserts, frozen fruit desserts, ice desserts, coffee, tea, cocoa, sugar, rice, tapioca, sago, artificial coffee, bread, pastry, treacle, salt, mustard, flour made from cereals, spices, food beverages (grain-based and herbal), gravies, herbal tea, honey, popcorn.) (526): Registration of this mark shall give no right to the exclusive use of the word 'COCO' separately and apart from the mark as a whole. The Arabic characters are a transliteration of 'Coco Crispy' (730): INTERNATIONAL FOODSTUFFS CO. LLC. of Al-Wahda Street, Industrial Area No.1 P.O. Box 4115 Sharjah, United Arab Emirates (740): Talal Abu-Ghazaleh Intellectual Property of P.O. Box 2537 - 00606, Nairobi, Kenya

COCO CRISPYS
كوكو كريسبي

(210): 125926 (220): 09/01/2023

(300): None (511): 30(Chocolates, confectionery, candies, biscuits, cakes, pasta, macaroni, noodles, instant noodles, spaghetti, vermicelli, yeast, baking powder and other bakery ingredients, salad dressings, mayonnaise, vinegar, ketchup and sauces(condiments), ready to cook dough products, frozen dough, frozen parathas, ice creams, non-dairy frozen desserts, frozen fruit desserts, ice desserts, coffee, tea, cocoa, sugar, rice, tapioca, sago, artificial coffee, bread, pastry, treacle, salt, mustard, flour made from cereals, spices, food beverages (grain-based and herbal), gravies, herbal tea, honey, popcorn.) (526): Registration of this mark shall give no right to the exclusive use of the word 'Rice' and the letter 'N' each separately and apart from the mark as a whole. The Arabic characters are a transliteration of 'Rice N Shine' (730): INTERNATIONAL FOODSTUFFS CO. LLC. of Al-Wahda Street, Industrial Area No.1 P.O. Box 4115 Sharjah, United Arab Emirates (740): Talal Abu-Ghazaleh Intellectual Property of P.O. Box 2537 - 00606, Nairobi, Kenya

RICE N SHINE
رايس ان شاين

(210): 125927 (220): 09/01/2023

(300): None (511): 30(Chocolates, confectionery, candies, biscuits, cakes, pasta, macaroni, noodles, instant noodles, spaghetti, vermicelli, yeast, baking powder and other bakery ingredients, salad dressings, mayonnaise, vinegar, ketchup and sauces(condiments), ready to cook dough products, frozen dough, frozen parathas, ice creams, non-dairy frozen desserts, frozen fruit desserts, ice desserts, coffee, tea, cocoa, sugar, rice, tapioca, sago, artificial coffee, bread, pastry, treacle, salt, mustard, flour made from cereals, spices, food beverages (grain-based and herbal), gravies, herbal tea, honey, popcorn.) (526): Registration of this mark shall give no right to the exclusive use of the word 'Rice' separately and apart from the mark as a whole. The Arabic characters are a transliteration of 'Rice Pops' (730): INTERNATIONAL FOODSTUFFS CO. LLC. of Al-Wahda Street, Industrial Area No.1 P.O. Box 4115 Sharjah, United Arab Emirates (740): Talal Abu-Ghazaleh Intellectual Property of P.O. Box 2537 - 00606, Nairobi, Kenya

RICE POPS
رايس بوبس

(210): 125931 (220): 09/01/2023

(300): None (511): 5(Pharmaceutical and veterinary preparations; sanitary preparations for medical purposes; dietetic substances adapted for medical use, food for babies; plasters, materials for dressings; material for stopping teeth, dental wax ; disinfectants; sanitizers) (526): None (730): PHARMAZON HEALTHCARE LIMITED of P.O. Box 102165 - 00101, Nairobi, Kenya (740): None

PENIMACILLIN

(210): 125935 (220): 10/01/2023

(300): None (511): 19(Building materials (non-metallic); non-metallic rigid pipes for building; asphalt, pitch and bitumen; non-metallic transportable buildings; monuments, not of metal) (526): Registration of this mark shall give no right to the exclusive use of the words 'TILES', 'BUILD' and device of 'Roof' per se each separately and apart from the mark as a whole. (730): KINGS TILES LIMITED of P.O. Box 105193 - 00101, Nairobi, Kenya (740): None



(210): 125936 (220): 10/01/2023

(300): None (511): 19(Building materials (non-metallic); non-metallic rigid pipes for building; asphalt, pitch and bitumen; non-metallic transportable buildings; monuments, not of metal) (526): None (730): COSMIC LIGHT LIMITED of P. O. Box 105193 - 00101, Nairobi, Kenya (740): None



(210): 125952 **(220):** 11/01/2023
(300): None **(511):** 1(Chemicals used in industry, science and photography, as well as in agriculture, horticulture and forestry; unprocessed artificial resins, unprocessed artificial resins, unprocessed plastics; manures; fire extinguishing compositions; tempering and soldering preparations; chemical substances ; adhesives used in industry) **(526):** 'NUTARI' is a coined word with no meaning **(730):** KOPPERT BILOGICAL SYSTEMS of P.O. Box 41852 - 00100, Nairobi, Kenya **(740):** None

NUTARI

(210): 125954 **(220):** 11/01/2023
(300): None **(511):** 1(Chemicals used in industry, science and photography, as well as in agriculture, horticulture and forestry; unprocessed artificial resins, unprocessed artificial resins, unprocessed plastics; manures; fire extinguishing compositions; tempering and soldering preparations; chemical substances ; adhesives used in industry) **(526):** Registration of this mark shall give no right to the exclusive use of the word 'MITE' separately and apart from the mark as a whole. **(730):** KOPPERT BILOGICAL SYSTEMS of P.O. Box 41852 - 00100, Nairobi, Kenya **(740):** None

MONTDO-MITE

(210): 125957 **(220):** 11/01/2023
(300): None **(511):** 34(Cigarettes; tobacco, raw or manufactured; tobacco products; tobacco substitutes (not for medical purposes); cigars; cigarillos; lighters for smokers; matches; smokers' articles; cigarette paper, cigarette tubes; cigarette filters; pocket apparatus for rolling cigarettes; hand held machines for injecting tobacco into paper tubes; electronic cigarettes; cartridges for electronic cigarettes; liquids for electronic cigarettes; tobacco products for the purpose of being heated; devices and parts for devices for heating tobacco; tobacco substitutes for the purpose of inhalation; cigarettes containing tobacco substitutes; cigarette cases; cigarette boxes; snus with tobacco; snuff with tobacco; snus without tobacco; snuff without tobacco; tobacco free oral nicotine pouches (not for medical use). **(526):** None **(730):** NICOVENTURES HOLDINGS LIMITED of Globe House, 1 Water Street, London WC2R 3LA, United Kingdom **(740):** Iseme, Kamau & Maema Advocates of P.O. Box 11866 - 00400, Nairobi, Kenya

VUSE PRO

(210): 125971 **(220):** 12/01/2023
(300): None **(511):** 35(Advertising, Business Management, Business Administration, Office Functions) **(526):** Registration of this mark shall give no right to the exclusive use of the words "Smart" and "Books" and the letter "B" each separately and apart from the mark as a whole. **(730):** GEM FINANCIAL MANAGEMENT LIMITED of P.O. Box 21360 - 00100, Nairobi, Kenya **(740):** None



(210): 125972 **(220):** 12/01/2023
(300): None **(511):** 32(Mineral and aerated waters) **(526):** None **(730):** AMOURZAAP ENTERPRISE LIMITED of P. O. Box 2509 - 00610, Nairobi, Kenya **(740):** None



(210): 125977 **(220):** 12/01/2023

(300): None **(511):** 16(Paper and cardboard; printed matter; bookbinding material; photographs; stationery and office requisites, except furniture; adhesives for stationery or household purposes; drawing materials and materials for artists; paintbrushes; instructional and teaching materials; plastic sheets, films and bags for wrapping and packaging; printers' type, printing blocks.), 35(Advertising; business management, organization and administration; office functions.) and 41(Education; providing of training; entertainment; sporting and cultural activities.) **(526):** Registration of this mark shall give no right to the exclusive use of the letters 'M' and 'O' each separately and apart from the mark as a whole. **(730):** OMOGAMBI OMOGAMBI GROUP LTD of P.O. Box 25452 - 00603, Nairobi, Kenya **(740):** None

**(210):** 125978 **(220):** 12/01/2023

(300): None **(511):** 3(Hair Oil) **(526):** Registration of this mark shall give no right to the exclusive use of the words 'LUXURIANT', 'ASIAN', 'HERBS' and device of a 'Leaf' each separately and apart from the mark as a whole. **(730):** TOJEKO HOLDINGS LIMITED of P.O. Box 2 - 40107, Homabay, Kenya **(740):** None

**(210):** 125986 **(220):** 13/01/2023

(300): None **(511):** 41(Education; providing of training; entertainment; sporting and cultural activities) **(526):** Registration of this mark shall give no right to the exclusive use of the word 'Bet' separately and apart from the mark as a whole. **(730):** ULTRABET LIMITED of P.O. Box 44380 - 00100, Nairobi, Kenya **(740):** None

ULTRABET

(210): 126001 **(220):** 16/01/2023

(300): None **(511):** 30(Tea.) **(526):** Registration of this mark shall give no right to the exclusive use of the word "Chai" and the devices of "saucer", "cup of tea" and "tea leaves" each separately and apart from the mark as a whole. The translation of the words "Waa Shaaha Waqtiga" is "Tea of the time", "Chai" is "Tea" while "Bahja" is a coined word with no meaning. **(730):** BYLINE SWIFT SERVICES LIMITED of P.O. Box 2216 - 80100, Mombasa, Kenya **(740):** None

**(210):** 126003 **(220):** 16/01/2023

(300): None **(511):** 29(Cooking oil/ edible oil) **(526):** Registration of this mark shall give no right to the exclusive use of the words 'ELGON' and 'OIL' each separately and apart from the mark as a whole. **(730):** HIGHLINE INDUSTRY LIMITED of P.O. Box 86511 - 80100, Mombasa, Kenya **(740):** None

ELGON
Oil

(210): 126012 **(220):** 16/01/2023

(300): None **(511):** 19(Building materials (non-metallic); non-metallic rigid pipes for building; asphalt, pitch and bitumen; non-metallic transportable buildings; monuments not of metal) **(526):** Registration of this mark shall give no right to the exclusive use of the words 'CERAMIC' and 'WORLD' each separately and apart from the mark as a whole. **(730):** DAMICO CERAMIC LIMITED of P.O. Box 43426, Mombasa, Kenya **(740):** None

CERAMIC WORLD

(210): 126018 **(220):** 16/01/2023

(300): None **(511):** 5(Pharmaceutical and veterinary preparations; sanitary preparations for medical purposes; dietetic substances adapted for medical use, food for babies; plasters, materials for dressings; material for stopping teeth, dental wax; disinfectants; sanitizers) **(526):** None **(730):** GOODMED PHARMACY LIMITED of P.O. Box 76337 - 00508, Nairobi, Kenya **(740):** None

BUPISTAR

<p>(210): 126019 (220): 16/01/2023 (300): None (511): 5(Pharmaceutical and veterinary preparations; sanitary preparations for medical purposes; dietetic substances adapted for medical use, food for babies; plasters, materials for dressings; material for stopping teeth, dental wax; disinfectants; sanitizers) (526): None (730): GOODMED PHARMACY LIMITED of P.O. Box 76337 - 00508, Nairobi, Kenya (740): None</p>	ATRASTAR
<p>(210): 126020 (220): 16/01/2023 (300): None (511): 5(Pharmaceutical and veterinary preparations; sanitary preparations for medical purposes; dietetic substances adapted for medical use, food for babies; plasters, materials for dressings; material for stopping teeth, dental wax; disinfectants; sanitizers) (526): None (730): GOODMED PHARMACY LIMITED of P.O. Box 76337 - 00508, Nairobi, Kenya (740): None</p>	ADRESTAR
<p>(210): 126021 (220): 16/01/2023 (300): None (511): 5(Pharmaceutical and veterinary preparations; sanitary preparations for medical purposes; dietetic substances adapted for medical use, food for babies; plasters, materials for dressings; material for stopping teeth, dental wax; disinfectants; sanitizers) (526): None (730): GOODMED PHARMACY LIMITED of P.O. Box 76337 - 00508, Nairobi, Kenya (740): None</p>	NERVIGESIC
<p>(210): 126032 (220): 18/01/2023 (300): None (511): 7(Machines, machines tools, power operated tools, motar and engines (except for land vehicles), machines coupling and transmission components (except for land vehicles) agricultural implements other than hand-operated hand tools, incubators for eggs, automatic vending machines) (526): None (730): VISION TECNO TRADE CO. LIMITED of P.O. Box 9658 - 40141, Nairobi, Kenya (740): Kijala And Muganda Advocates of P.O. Box 4227 - 00100, Nairobi, Kenya</p>	PULSAR
<p>(210): 126035 (220): 18/01/2023 (300): None (511): 1(Litmus papers.) (526): None (730): SCHOOL EQUIPMENT CENTRE LTD of P.O. Box 11155 - 00400, Nairobi, Kenya (740): None</p>	JOHNSON
<p>(210): 126036 (220): 18/01/2023 (300): None (511): 16(Paper, cardboard and goods made from these materials, not included in other classes; Printed matter; Bookbinding material; Photographs; Stationery; Adhesives for stationery or household purposes; Artists' materials; Paint brushes; Typewriters and office requisites (except furniture); Instructional and teaching material (except apparatus); Plastic materials for packaging (not included in other classes) (526): Registration of this mark shall give no right to the exclusive use of the word "COLOR" separately and apart from the mark as a whole. (730): SCHOOL EQUIPMENT CENTRE LTD of P.O. Box 11155 - 00400, Nairobi, Kenya (740): None</p>	JORDAN COLOR
<p>(210): 126037 (220): 18/01/2023 (300): None (511): 9(Analytical and precision balances.) (526): None (730): SCHOOL EQUIPMENT CENTRE LTD of P.O. Box 11155 - 00400, Nairobi, Kenya (740): None</p>	OHAUS
<p>(210): 126038 (220): 18/01/2023 (300): None (511): 1(Diagnostic preparations for analytical, research and scientific use.) (526): Sanskrit word "PALLA V" means "new born leaf of any tree (730): SCHOOL EQUIPMENT CENTRE LTD of P.O. Box 11155 - 00400, Nairobi, Kenya (740): None</p>	PALLAV
<p>(210): 126039 (220): 18/01/2023 (300): None (511): 9(Scientific, nautical, surveying, photographic, cinematographic, optical, weighing, measuring, signaling, checking (supervision), life-saving and teaching apparatus and instruments.) (526): Sanskrit word "SUSWOX" is a coined word. (730): SCHOOL EQUIPMENT CENTRE LTD of P.O. Box 11155 - 00400, Nairobi, Kenya (740): None</p>	SUSWOX

(210): 126040 (220): 18/01/2023
 (300): None (511): 1(Analytical and laboratory chemicals.) (526):
 None (730): SCHOOL EQUIPMENT CENTRE LTD of P.O. Box 11155 -
 00400, Nairobi, Kenya (740): None

THOMAS BAKER

(210): 126048 (220): 19/01/2023
 (300): None (511): 9(Diaphragms [acoustics], slide projectors,
 portable media players, mobile, telephones, smartphones, foldable
 smartphones, cameras [photography], projection screens, video
 projectors, batteries, electric, monitoring apparatus, other than for
 medical purposes, portable power chargers, mobile phone chargers,
 tablet computers, notebook computers, identity cards, magnetic.)
 (526): "UMIIO" is a coined word with no meaning. (730): SHENZHEN
 LIANYUXUN TECHNOLOGY CO., LTD of C24A, 24 Floor, Block C,
 Electronic Technology Building, Huaqiangbei Road, Futian District,
 China (740): Ong'anya Ombo Advocates LLP of P.O. Box 15598 -
 00400, Nairobi, Kenya



(210): 126054 (220): 19/01/2023
 (300): None (511): 35(Business Risk Management) (526):
 Registration of this mark shall give no right to the exclusive use of
 the words 'Ridge', 'Corporate', 'Risk', 'Management', 'Ltd', and the
 letter 'l' each separately and apart from the mark as a whole. (730):
 RIDGE CORPORATE RISK MANAGEMENT LTD of P.O. Box 28486 -
 00100, Nairobi, Kenya (740): None



(210): 126055 (220): 19/01/2023
 (300): None (511): 38(Telecommunications) (526): Registration of
 this mark shall give no right to the exclusive use of the acronym 'FM',
 the numerals '89' and the devices of the 'Airwaves' and 'Human' each
 separately and apart from the mark as a whole. The translation into
 English of the Samburu vernacular words 'Reto Ltoilo Linchi' is 'Your
 Voice Is Your Help' (730): SAMBURU COMMUNITY RADIO of P.O. Box
 373 - 20600, Maralal, Kenya (740): None



(210): 126060 (220): 19/01/2023
 (300): None (511): 21(Household or kitchen utensils and containers;
 combs and sponges; brushes (except paint brushes); brush-making
 materials; articles for cleaning purposes; steel wool; unworked or
 semi worked glass (except glass used in building); glassware,
 porcelain and earthenware not included in other classes.) (526):
 Registration of this mark shall give no right to the exclusive use of
 the words 'CERAMIC', 'WATER', 'FILTER' and the devices of the 'water
 tap' and 'water drops' each separately and apart from the mark as a
 whole. (730): SPOUTS OF WATER LTD of P.O. Box 12042 Kampala,
 Uganda (740): Florence Anyango Otieno Advocate of P.O. Box 30670 -
 00100, Nairobi, Kenya



(210): 126061 (220): 19/01/2023
 (300): None (511): 30(Coffee, tea, cocoa, artificial coffee; rice;
 tapioca and sago; flour and preparations made from cereals; bread,
 pastry and confectionery; sugar, honey, treacle; yeast, baking-
 powder; salt, mustard; vinegar, sauces (condiments); spices; ice)
 (526): Registration of this mark shall give no right to the exclusive
 use of the words 'RONGAI', 'BREAD' and the device of the 'wheat
 grain' each separately and apart from the mark as a whole. (730):
 MILA MILL LIMITED of P.O. Box 101389 - 00101, Laiser Ongata Rongai,
 Nairobi, Kenya (740): None



(210): 126062 (220): 20/01/2023

(300): None (511): 44(Medical services; veterinary services; hygienic and beauty care for human beings or animals; agriculture, aquaculture, horticulture and forestry services.) (526): Registration of this mark shall give no right to the exclusive use of the words 'Mama', 'Health' and the devices of "human beings" each separately and apart from the mark as a whole. 'Mama' is a swahili word meaning 'mother' in English. (730): JACARANDA HEALTH SOLUTIONS LIMITED of P.O. Box 52595 - 00100, 789 Jabavu Rd, Nairobi, Kenya (740): None



(210): 126063 (220): 20/01/2023

(300): None (511): 30(Confectionery, bread, pastry; Edible ices; Sugar, honey, treacle; Yeast, baking-powder; Salt; Mustard; Vinegar, sauces (condiments); Spices; Ice.) (526): Registration of this mark shall give no right to the exclusive use of the words 'Protein', 'Packed', 'Chocolate', 'Chip' and 'Cookies' each separately and apart from the mark as a whole. (730): NUTRI DELIGHTS LTD. of Rafiki Miller's Warehouse, 1st Floor, P.O. Box 38196 - 00623, Nairobi, Kenya (740): None



(210): 126064 (220): 20/01/2023

(300): None (511): 30(Confectionery, bread, pastry; Edible ices; Sugar, honey, treacle; Yeast, baking-powder; Salt; Mustard; Vinegar, sauces (condiments); Spices; Ice.) (526): Registration of this mark shall give no right to the exclusive use of the words 'Red', 'Chocolate', 'Chip' and 'Cookies' each separately and apart from the mark as a whole. (730): NUTRI DELIGHTS LTD. of Rafiki Miller's Warehouse, 1st Floor, P.O. Box 38196 - 00623, Nairobi, Kenya (740): None



(210): 126065 (220): 20/01/2023

(300): None (511): 30(Confectionery, bread, pastry; Edible ices; Sugar, honey, treacle; Yeast, baking-powder; Salt; Mustard; Vinegar, sauces (condiments); Spices; Ice.) (526): Registration of this mark shall give no right to the exclusive use of the words 'DELIGHT' and 'BAKED' each separately and apart from the mark as a whole. (730): NUTRI DELIGHTS LTD. of Rafiki Miller's Warehouse, 1st Floor, P.O. Box 38196 - 00623, Nairobi, Kenya (740): None



(210): 126066 (220): 20/01/2023

(300): None (511): 30(Confectionery, bread, pastry; Edible ices; Sugar, honey, treacle; Yeast, baking-powder; Salt; Mustard; Vinegar, sauces (condiments); Spices; Ice.) (526): Registration of this mark shall give no right to the exclusive use of the words 'Spirulina', 'Cookies' and 'Nutrition' each separately and apart from the mark as a whole. (730): NUTRI DELIGHTS LTD. of Rafiki Miller's Warehouse, 1st Floor, P.O. Box 38196 - 00623, Nairobi, Kenya (740): None



(210): 126068 (220): 20/01/2023

(300): None (511): 5(Veterinary drug) (526): Registration of this mark shall give no right to the exclusive use of the word 'FORTE' separately and apart from the mark as a whole. (730): ANIMIX LIMITED of P.O. Box 1 - 00515, Nairobi, Kenya (740): None

PENTOSTREP FORTE

(210): 126071 (220): 20/01/2023

(300): None (511): 16(Tissue paper.) (526): "DALIA" is a Hebrew name meaning a 'branch' (730): VELASCO ENTERPRISES of P.O. Box 60230 - 00200, Nairobi, Kenya (740): None

DALIA

(210): 126072 (220): 20/01/2023
 (300): None (511): 35(Advertising; business management; business administration; office functions.), 37(Building construction; repair; installation services.) and 42(Scientific and technological services and research and design relating thereto; industrial analysis and research services; design and development of computer hardware and software.) (526): Registration of this mark shall give no right to the exclusive use of the words 'SISIBO', 'ECONOMIC', 'ZONES' and "SPECIAL" each separately and apart from the mark as a whole. (730): AFRICA ECONOMIC ZONES LIMITED of Plot No. MN/111492, Ground Floor, Greenwood Drive, Nyali, P.O. Box 81737 - 80100, Mombasa, Kenya (740): None



(210): 126092 (220): 20/01/2023
 (300): None (511): 12(Vehicles; apparatus for locomotion by land, air or water) (526): Registration of this mark shall give no right to the exclusive use of the letters 'D', 'G' and the word 'AFRICA' each separately and apart from the mark as a whole. (730): DENNIS GITHUI MWANGI of P.O. Box 12146 - 00400, Nairobi, Kenya (740): None



(210): 126123 (220): 23/01/2023
 (300): None (511): 5(Pharmaceuticals.) (526): None (730): KRISHNA CHEMISTS LTD. of P.O. Box 3328 - 00506, Nairobi, Kenya (740): None

COTRIBACT

(210): 126124 (220): 23/01/2023
 (300): None (511): 5(Pharmaceuticals.) (526): None (730): KRISHNA CHEMISTS LTD. of P.O. Box 3328 - 00506, Nairobi, Kenya (740): None

SEDAX

(210): 126125 (220): 23/01/2023
 (300): None (511): 5(Pharmaceuticals.) (526): None (730): KRISHNA CHEMISTS LTD. of P.O. Box 3328 - 00506, Nairobi, Kenya (740): None

DOPAZIDE

(210): 126127 (220): 23/01/2023
 (300): None (511): 5(Pharmaceuticals) (526): None (730): KRISHNA CHEMISTS LTD. of P.O. Box 3328 - 00506, Nairobi, Kenya (740): None

ABIRAKEN

(210): 126128 (220): 23/01/2023
 (300): None (511): 5(Pharmaceuticals) (526): None (730): KRISHNA CHEMISTS LTD. of P.O. Box 3328 - 00506, Nairobi, Kenya (740): None

AZYKEN

(210): 126129 (220): 23/01/2023
 (300): None (511): 5(Pharmaceuticals) (526): None (730): KRISHNA CHEMISTS LTD. of P.O. Box 3328 - 00506, Nairobi, Kenya (740): None

BORTEKEN

(210): 126130 (220): 23/01/2023
 (300): None (511): 5(Pharmaceuticals) (526): None (730): KRISHNA CHEMISTS LTD. of P.O. Box 3328 - 00506, Nairobi, Kenya (740): None

CAPECIKEN

(210): 126131 (220): 23/01/2023
 (300): None (511): 5(Pharmaceuticals) (526): None (730): KRISHNA CHEMISTS LTD. of P.O. Box 3328 - 00506, Nairobi, Kenya (740): None

CARBOKEN

(210): 126132 (220): 23/01/2023
 (300): None (511): 5(Pharmaceuticals) (526): None (730): KRISHNA CHEMISTS LTD. of P.O. Box 3328 - 00506, Nairobi, Kenya (740): None

PLATIKEN

(210): 126133 (220): 23/01/2023
 (300): None (511): 5(Pharmaceuticals) (526): None (730): KRISHNA CHEMISTS LTD. of P.O. Box 3328 - 00506, Nairobi, Kenya (740): None

CISPLAKEN

(210): 126134 (220): 23/01/2023 (300): None (511): 5(Pharmaceuticals) (526): None (730): KRISHNA CHEMISTS LTD. of P.O. Box 3328 - 00506, Nairobi, Kenya (740): None	CYCLOKEN
(210): 126135 (220): 23/01/2023 (300): None (511): 5(Pharmaceuticals) (526): None (730): KRISHNA CHEMISTS LTD. of P.O. Box 3328 - 00506, Nairobi, Kenya (740): None	DOCETAKEN
(210): 126136 (220): 23/01/2023 (300): None (511): 5(Pharmaceuticals) (526): None (730): KRISHNA CHEMISTS LTD. of P.O. Box 3328 - 00506, Nairobi, Kenya (740): None	EPIRUKEN
(210): 126137 (220): 23/01/2023 (300): None (511): 5(Pharmaceuticals) (526): None (730): KRISHNA CHEMISTS LTD. of P.O. Box 3328 - 00506, Nairobi, Kenya (740): None	FLUROKEN
(210): 126138 (220): 23/01/2023 (300): None (511): 5(Pharmaceuticals) (526): None (730): KRISHNA CHEMISTS LTD. of P.O. Box 3328 - 00506, Nairobi, Kenya (740): None	GEMIKEN
(210): 126139 (220): 23/01/2023 (300): None (511): 5(Pharmaceuticals) (526): None (730): KRISHNA CHEMISTS LTD. of P.O. Box 3328 - 00506, Nairobi, Kenya (740): None	IFOSFAKEN
(210): 126140 (220): 23/01/2023 (300): None (511): 5(Pharmaceuticals) (526): None (730): KRISHNA CHEMISTS LTD. of P.O. Box 3328 - 00506, Nairobi, Kenya (740): None	IMATIKEN
(210): 126141 (220): 23/01/2023 (300): None (511): 5(Pharmaceuticals) (526): None (730): KRISHNA CHEMISTS LTD. of P.O. Box 3328 - 00506, Nairobi, Kenya (740): None	IRINOKEN
(210): 126142 (220): 23/01/2023 (300): None (511): 5(Pharmaceuticals) (526): None (730): KRISHNA CHEMISTS LTD. of P.O. Box 3328 - 00506, Nairobi, Kenya (740): None	LENALIKEN
(210): 126143 (220): 23/01/2023 (300): None (511): 5(Pharmaceuticals) (526): None (730): KRISHNA CHEMISTS LTD. of P.O. Box 3328 - 00506, Nairobi, Kenya (740): None	LEUCOKEN
(210): 126144 (220): 23/01/2023 (300): None (511): 5(Pharmaceuticals) (526): None (730): KRISHNA CHEMISTS LTD. of P.O. Box 3328 - 00506, Nairobi, Kenya (740): None	NABLIKEN
(210): 126145 (220): 23/01/2023 (300): None (511): 5(Pharmaceuticals) (526): None (730): KRISHNA CHEMISTS LTD. of P.O. Box 3328 - 00506, Nairobi, Kenya (740): None	PACLIKEN
(210): 126146 (220): 23/01/2023 (300): None (511): 5(Pharmaceuticals) (526): None (730): KRISHNA CHEMISTS LTD. of P.O. Box 3328 - 00506, Nairobi, Kenya (740): None	FILGRAKEN
(210): 126147 (220): 23/01/2023 (300): None (511): 5(Pharmaceuticals) (526): None (730): KRISHNA CHEMISTS LTD. of P.O. Box 3328 - 00506, Nairobi, Kenya (740): None	PEGFIKEN
(210): 126148 (220): 23/01/2023 (300): None (511): 5(Pharmaceuticals) (526): None (730): KRISHNA CHEMISTS LTD. of P.O. Box 3328 - 00506, Nairobi, Kenya (740): None	OXALIKEN

(210): 126149 (220): 23/01/2023 (300): None (511): 5(Pharmaceuticals) (526): None (730): KRISHNA CHEMISTS LTD. of P.O. Box 3328 - 00506, Nairobi, Kenya (740): None	PEMETREKEN
(210): 126150 (220): 23/01/2023 (300): None (511): 5(Pharmaceuticals) (526): None (730): KRISHNA CHEMISTS LTD. of P.O. Box 3328 - 00506, Nairobi, Kenya (740): None	SORAKEN
(210): 126151 (220): 23/01/2023 (300): None (511): 5(Pharmaceuticals) (526): None (730): KRISHNA CHEMISTS LTD. of P.O. Box 3328 - 00506, Nairobi, Kenya (740): None	TEMOKEN
(210): 126152 (220): 23/01/2023 (300): None (511): 5(Pharmaceuticals) (526): None (730): KRISHNA CHEMISTS LTD. of P.O. Box 3328 - 00506, Nairobi, Kenya (740): None	CRISTIKEN
(210): 126153 (220): 23/01/2023 (300): None (511): 5(Pharmaceuticals) (526): None (730): KRISHNA CHEMISTS LTD. of P.O. Box 3328 - 00506, Nairobi, Kenya (740): None	VIRELBIKEN
(210): 126154 (220): 23/01/2023 (300): None (511): 5(Pharmaceuticals) (526): None (730): KRISHNA CHEMISTS LTD. of P.O. Box 3328 - 00506, Nairobi, Kenya (740): None	ZOLDROKEN
(210): 126155 (220): 23/01/2023 (300): None (511): 5(Pharmaceuticals) (526): None (730): KRISHNA CHEMISTS LTD. of P.O. Box 3328 - 00506, Nairobi, Kenya (740): None	ENZALUKEN
(210): 126156 (220): 23/01/2023 (300): None (511): 5(Pharmaceuticals) (526): None (730): KRISHNA CHEMISTS LTD. of P.O. Box 3328 - 00506, Nairobi, Kenya (740): None	DOXOKEN
(210): 126157 (220): 23/01/2023 (300): None (511): 5(Pharmaceuticals) (526): None (730): KRISHNA CHEMISTS LTD. of P.O. Box 3328 - 00506, Nairobi, Kenya (740): None	BEMABKEN
(210): 126158 (220): 23/01/2023 (300): None (511): 5(Pharmaceuticals) (526): None (730): KRISHNA CHEMISTS LTD. of P.O. Box 3328 - 00506, Nairobi, Kenya (740): None	CABAZIKEN
(210): 126159 (220): 23/01/2023 (300): None (511): 5(Pharmaceuticals) (526): None (730): KRISHNA CHEMISTS LTD. of P.O. Box 3328 - 00506, Nairobi, Kenya (740): None	CYTARAKEN
(210): 126160 (220): 23/01/2023 (300): None (511): 5(Pharmaceuticals) (526): None (730): KRISHNA CHEMISTS LTD. of P.O. Box 3328 - 00506, Nairobi, Kenya (740): None	TRAZKEN
(210): 126161 (220): 23/01/2023 (300): None (511): 5(Pharmaceuticals) (526): None (730): KRISHNA CHEMISTS LTD. of P.O. Box 3328 - 00506, Nairobi, Kenya (740): None	PALBOKEN
(210): 126162 (220): 23/01/2023 (300): None (511): 5(Pharmaceuticals) (526): None (730): KRISHNA CHEMISTS LTD. of P.O. Box 3328 - 00506, Nairobi, Kenya (740): None	RIMABKEN

(210): 126163 (220): 23/01/2023

(300): None (511): 12(Motor vehicle spare parts) (526): Registration of this mark shall give no right to the exclusive use of the words 'VERSATILE', 'SERVICE', 'AUTO', 'PARTS' and 'ACCESSORIES' each separately and apart from the mark as a whole. (730): KONTINENTAL BEARINGS & HUB ASSEMBLIES LIMITED of P.O. Box 70064 - 00400, Tom Mboya St, Nairobi, Kenya (740): None



RUBIKEN

(210): 126164 (220): 23/01/2023

(300): None (511): 5(Pharmaceuticals) (526): None (730): KRISHNA CHEMISTS LTD. of P.O. Box 3328 - 00506, Nairobi, Kenya (740): None

(210): 126181 (220): 24/01/2023

(300): None (511): 5(Pharmaceuticals) (526): None (730): GLOBE PHARMACY LIMITED of P.O. Box 58171 - 00200, Nairobi, Kenya (740): None

DETECTIN

(210): 126238 (220): 27/01/2023

(300): None (511): 36(Financial service) (526): Registration of this mark shall give no right to the exclusive use of the words 'CASH', 'DIRECT' and the acronym 'Ksh' each separately and apart from the mark as a whole. (730): SURE CRED CAPITAL LIMITED of P.O. Box 1466 - 00618, Nairobi, Kenya (740): None



(210): 126239 (220): 27/01/2023

(300): None (511): 3(Bleaching preparations and other substances for laundry use, cleaning, polishing, scouring and abrasive preparations; soaps; Perfumery, essential oils, cosmetics, hair lotions; dentifrices.) (526): Registration of this mark shall give no right to the exclusive use of the word 'Pink' separately and apart from the mark as a whole. (730): TOLARAM EAST AFRICA CONSUMER PRODUCTS LIMITED of P.O. Box 677 - 00606, Nairobi, Kenya (740): None



(210): 126240 (220): 27/01/2023

(300): None (511): 26(Hair additions.) (526): Registration of this mark shall give no right to the exclusive use of the word 'PINK' separately and apart from the mark as a whole. (730): TOLARAM EAST AFRICA CONSUMER PRODUCTS LIMITED of P.O. Box 677 - 00606, Nairobi, Kenya (740): None



(210): 126241 (220): 27/01/2023

(300): None (511): 21(Household for utensils.) (526): Registration of this mark shall give no right to the exclusive use of the word "INDUSTRY", "LIMITED" and the device of "Diamond" each separately and apart from the mark as a whole. (730): OMIC INDUSTRY LIMITED of P.O. Box 99230 - 80107, Kenya (740): None



(210): 126243 (220): 27/01/2023

(300): None (511): 29(Cooking oil) (526): None (730): ABDIAZIZ YUSUF DORE of P.O. Box 6100 - 7190, Eldoret, Kenya (740): None



(210): 126256 (220): 30/01/2023

(300): None (511): 5(Pesticides, fungicides, herbicides, insecticides) (526): None (730): ADAMA MAKHTESHIM LTD of P.O. Box 60, Beer Sheva 8410001, Israel (740): Coulson Harvey Advocates of P.O. Box 10643 - 00100, Nairobi, Kenya

FOLPAN

(210): 126259 (220): 31/01/2023

(300): None (511): 30(Tea, coffee, rice, flour, bread, honey, confectionery, bread, sugar, spices, baking powder, vinegar, salt, pastry, sauces, all flour made from cereals, ice, value addition in food products) (526): IRegistration of this mark shall give no right to the exclusive use of the device of 'Tree' and letter "i" each separately and apart from the mark as a whole. (730): BIDII TRENDS ENGINEERING LTD of P. O. Box 3063 - 00200, Nairobi, Kenya (740): None



(210): 126263 (220): 31/01/2023

(300): None (511): 5(Pharmaceutical and veterinary preparations; sanitary preparations for medical purposes; dietetic substances adapted for medical use, food for babies; plasters, materials for dressings; material for stopping teeth, dental wax; disinfectants; sanitizers) (526): Registration of this mark shall give no right to the exclusive use of the word 'PLUS' separately and apart from the mark as a whole. (730): GLASOLINE PHARMACEUTICALS LIMITED of P.O. Box 14 - 20113, Nakuru, Kenya (740): None

GLASONORM PLUS

(210): 126264 (220): 31/01/2023

(300): None (511): 5(Pharmaceutical and veterinary preparations; sanitary preparations for medical purposes; dietetic substances adapted for medical use, food for babies; plasters, materials for dressings; material for stopping teeth, dental wax; disinfectants; sanitizers) (526): None (730): GLASOLINE PHARMACEUTICALS LIMITED of P.O. Box 14 - 20113, Nakuru, Kenya (740): None

LACTOPEAD

(210): 126265 (220): 31/01/2023

(300): None (511): 5(Pharmaceutical and veterinary preparations; sanitary preparations for medical purposes; dietetic substances adapted for medical use, food for babies; plasters, materials for dressings; material for stopping teeth, dental wax; disinfectants; sanitizers) (526): Registration of this mark shall give no right to the exclusive use of the word 'PLUS' separately and apart from the mark as a whole. (730): GLASOLINE PHARMACEUTICALS LIMITED of P.O. Box 14 - 20113, Nakuru, Kenya (740): None

GLASOFLOR PLUS

(210): 126267 (220): 31/01/2023

(300): None (511): 29(Sunflower and edible oils.) (526): Registration of this mark shall give no right to the exclusive use of the words 'Tana', 'Fresh', 'Virgin', 'Sunflower', 'Oil' and devices of 'Sunflower' and 'Oil drop' each separately and apart from the mark as a whole. (730): LANDSTAR INVESTMENT COMPANY LIMITED of P.O. Box 16894 - 80100, Mombasa, Kenya (740): None



(210): 126271 (220): 31/01/2023

(300): None (511): 41(Provision of Education and Online training) (526): 'Digifunzi' is a coined word from Digital & Funzi meaning Digital Student in swahili (730): SHARED POSSIBILITY LTD of Thika West Centre, 3rd Floor Room 309A, P.O. Box 50041 - 00100, Nairobi, Kenya (740): None



(210): 126272 (220): 31/01/2023

(300): None (511): 36(Insurance; financial affairs; monetary affairs; real estate affairs) (526): Registration of this mark shall give no right to the exclusive use of the words "LEND", "Pro", "Capital" and the acronym "Ltd" each separately and apart from the mark as a whole. (730): DENNIS GITHUI MWANGI of P.O. Box 12146 - 00400, Nairobi, Kenya (740): None



(210): 126273 (220): 31/01/2023

(300): None (511): 36(Insurance; financial affairs; monetary affairs; real estate affairs) (526): Registration of this mark shall give no right to the exclusive use of the words 'Capital' and 'Limited' each separately and apart from the mark as a whole. (730): DENNIS GITHUI MWANGI of P. O. Box 12146 - 00400, Nairobi, Kenya (740): None



(210): 126274 (220): 31/01/2023

(300): None (511): 36(Insurance; financial affairs; monetary affairs; real estate affairs) (526): Registration of this mark shall give no right to the exclusive use of the words "Lend", 'Capital' and the acronym "Ltd" each separately and apart from the mark as a whole. (730): DENNIS GITHUI MWANGI of P.O. Box 12146 - 00400, Nairobi, Kenya (740): None



(210): 126277 (220): 01/02/2023

(300): None (511): 35(Advertising; business management, organization and administration; office functions) (526): Registration of this mark shall give no right to the exclusive use of the letters 'P' and 'R' each separately and apart from the mark as a whole (730): CALLA & JANE PR LIMITED of P.O. Box 22872 - 00505, Ngong Road, Kenya (740): None



(210): 126278 (220): 01/02/2023

(300): None (511): 35(Advertising; business management, organization and administration; office functions) (526): Registration of this mark shall give no right to the exclusive use of the words 'Banana', 'Mart', 'Fresh', 'Choice' and 'banana' device per se each separately and apart from the mark as a whole. (730): BANANA MART LIMITED of P. O. Box 229 - 70100, Garisa, Kenya (740): None



(210): 126282 (220): 01/02/2023

(300): None (511): 35(Advertising; business management, organization and administration; office functions) (526): Registration of this mark shall give no right to the exclusive use of the word 'MARGIN' separately and apart from the mark as a whole. (730): VESTED MARGINS LIMITED of P.O. Box 8151 - 00200, Nairobi, Kenya (740): None

VESTED MARGINS

(210): 126283 (220): 01/02/2023

(300): None (511): 29(Milk & milk products.) (526): Registration of this mark shall give no right to the exclusive use of the words 'MILK', 'INVESTMENT', 'LIMITED' and the device of a 'Drop of milk' each separately and apart from the mark as a whole. The translation into English of the Kiswahili word 'FURAHA' is 'Happy' (730): FURAHA MILK INVESTMENTS LIMITED of P.O. Box 13 - 70303, Mandera, Kenya (740): None



(210): 126286 (220): 01/02/2023

(300): None (511): 9(Mobile phones, earphones, chargers, smartwatch, batteries, power bank, camera flash, memory card, blue tooth speaker) (526): Registration of this mark shall give no right to the exclusive use of the letter 'Q' and the word 'Seven' each separately and apart from the mark as a whole. (730): LEVON TECHNOLOGY LIMITED of P.O. Box 3124 - 00506, Nairobi, Kenya (740): None

Q-SEVEN

(210): 126287 (220): 01/02/2023

(300): None (511): 9(Mobile phones, earphones, chargers, smartwatch, batteries, power bank, camera chargers, memory card, blue tooth speaker) (526): None (730): LEVON TECHNOLOGY LIMITED of P.O. Box 3124 - 00506, Nairobi, Kenya (740): None

CALVX

(210): 126294 **(220):** 01/02/2023

(300): None **(511):** 7(Motors & engines, electric motors for machines, water pumps, electrical water pumps, water pumps for motors) **(526):** Registration of this mark shall give no right to the exclusive use of the words 'Pumps' and 'Motors' each separately and apart from the mark as a whole. **(730):** VERSIL PUMPS LLP of Opp. Sardar School, Nr. Kangashiyali Village, Gondal Road, Dholara, Rajkot-360022 Gujarat, India **(740):** Kanchori Daniel & Co. Advocates of P.O. Box 800 - 241, Kitengela, Kenya

**(210):** 126313 **(220):** 02/02/2023

(300): None **(511):** 39(Arranging of tours.) **(526):** Registration of this mark shall give no right to the exclusive use of the word "SAFARI" separately and apart from the mark as a whole **(730):** JOURNEY HOME LIMITED of P.O. Box 67802 - 00200, Nairobi, Kenya **(740):** Gichuru & Co. Advocates of P.O. Box 67802 - 00200, Nairobi, Kenya

**(210):** 126316 **(220):** 03/02/2023

(300): None **(511):** 12(Motorcycle spare parts.) **(526):** Registration of this mark shall give no right to the exclusive use of the word "DYNAMIC" and "FORCE" each separately and apart from the mark as a whole **(730):** TOP RICH MOTORCYCLES K LTD of P.O. Box 12314 - 00100, Nairobi, Kenya **(740):** Gichuru & Co. Advocates of P.O. Box 67802 - 00200, Nairobi, Kenya

**(210):** 126342 **(220):** 06/02/2023

(300): None **(511):** 32(Drinking water.) **(526):** Registration of this mark shall give no right to the exclusive use of the words "KETO" and "Purified Drinking Water" each separately and apart from the mark as a whole. **(730):** KETO CAFE (K) LTD of P.O. Box 969 - 00610, Nairobi, Kenya **(740):** None

**(210):** 126359 **(220):** 06/02/2023

(300): None **(511):** 35(Administration of consumer loyalty programs; loyalty, incentive and bonus program services; membership program enabling participants to receive discounts and special promotions on hotels rooms and temporary lodging; administration of consumer loyalty programs; administration of frequent flyer programs; organization, operation and supervision of sales and promotional incentive schemes; administration of frequent flyer programs; administrative services for the relocation of businesses; advertising / publicity; advertising agency services / publicity agency services; advertising by mail order; production of advertising films; bill-posting; business auditing; business inquiries; business intermediary services relating to the matching of potential private investors with entrepreneurs needing funding; business management and organization consultancy; business management assistance; business management consultancy; business management of hotels; business management of reimbursement programmes for others / business management of reimbursement programs for others; business organization consultancy; business project management services for construction projects; providing business information; providing business information via a website; commercial administration of the licensing of the goods and services of others; commercial intermediation services; commercial or industrial management assistance; providing commercial and business contact information; providing commercial information and advice for consumers in the choice of products and services; compilation of information into computer databases; cost price analysis; demonstration of goods; development of advertising concepts; direct mail advertising; dissemination of advertising matter; economic forecasting; organization of exhibitions for commercial or advertising purposes;



organization of fashion shows for promotional purposes; market studies; Marketing; marketing research; negotiation and conclusion of commercial transactions for third parties; negotiation of business contracts for others; online advertising on a computer network; outsourced administrative management for companies; outsourcing services. [business assistance]; personnel recruitment; presentation of goods on communication media, for retail purposes; procurement services for others [purchasing goods and services for other businesses]; public relations; publication of publicity texts; radio advertising; rental of sales stands; sales promotion for others; search engine optimization for sales promotion / search engine optimization for sales promotion; sponsorship search; arranging subscriptions to telecommunication services for others; systemization of information into computer databases; telemarketing services; television advertising; organization of trade fairs; updating and maintenance of data in computer databases; updating and maintenance of information in registries; updating of advertising material; web indexing for commercial or advertising purposes; writing of publicity texts; advertising services to promote public awareness of environmental matters and environmental sustainability; management of retail malls and retail outlets; wholesale, online retail and in-store retail services relating to the sale of souvenirs, clothing, footwear, headgear, cosmetics, skincare, candles, perfumes, jewelry, sports and leisure equipment, books, photographs and stationery; business management of tourism destinations and resorts; business management of hotels; administrative hotel management; advertising in the field of tourism; information, consultancy and advice relating to the aforesaid), 36(Accommodation bureau services [apartments]; apartment house management; rental of apartments; brokerage*; capital investment; charitable fund raising; arranging finance for construction projects; financial analysis; financial consultancy; financial evaluation [insurance, banking, real estate]; financial management; financial sponsorship; providing financial information; financing services; insurance brokerage; insurance consultancy; insurance underwriting; providing insurance information; investment of funds; loans [financing]; rental of offices [real estate]; processing of credit card payments; processing of debit card payments; real estate agency services; real estate appraisal; real estate brokerage; real estate management; rental of real estate; issuance of tokens of value; issuance of travellers' cheques / issuance of travelers' checks; issuance of tokens of value; issuance of gift vouchers; management of real estate destinations and resorts; property portfolio management; land acquisition services; real estate services relating to the management of land; commercial investment services; property and real estate investment services; real estate investment trust management services; real estate brokerage, management, leasing and letting services; estate agency and property letting services; rental of permanent accommodation; rent collection services; management of rental property; services relating to the provision of finance for the purchase of buildings, homes, real estate and land; information, advice and consultancy services relating to the aforesaid.), 37(Construction services; land development services; airplane maintenance and repair; boiler cleaning and repair; Bricklaying; building construction supervision; building insulating; building of fair stalls and shops; building sealing / damp-proofing [building]; carpentry services; cleaning of buildings [exterior surface]; cleaning of buildings [interior]; rental of cleaning machines; construction consultancy; construction*; providing construction information; rental of construction equipment; rental of cranes [construction equipment]; demolition of buildings; dry cleaning; electric appliance installation and repair; furniture

maintenance; furniture restoration; harbor construction; heating equipment installation and repair; providing information relating to repairs; installation and repair of air-conditioning apparatus; installation of doors and windows; irrigation devices installation and repair; laying of cable; machinery installation, maintenance and repair; Masonry; office machines and equipment installation, maintenance and repair; painting or repair of signs; painting, interior and exterior; pest control services, other than for agriculture, aquaculture, horticulture and forestry; pipeline construction and maintenance; Plastering; Plumbing; road paving; roofing services; Sanding; Scaffolding; swimming-pool maintenance; underwater construction; underwater repair; vehicle maintenance; vehicle polishing; vehicle service stations [refueling and maintenance]; vehicle washing; warehouse construction and repair; window cleaning; land development services; construction services ; construction supervision; demolition services; roofing; building sealing; bricklaying; building insulating; pipeline construction; marine constructions; offshore construction; building maintenance; harbour and port construction; airport construction; construction of roads; construction of bridges; construction consultancy; construction information; building of stalls and shops at fairs; rental of construction equipment; maintenance services; maintenance of property; maintenance of buildings; maintenance of roads; maintenance of ports and harbours; maintenance of buildings; pipeline maintenance; maintenance of machinery; maintenance of vehicles; aeroplanes maintenance; building cleaning; furniture maintenance; building restoration; restoration of construction projects; installation services including in relation to appliances, plumbing, pipelines, electric cables, solar power, hydraulic power, hangers, elevators, engines, refrigerators; heating equipment installation; installation of air-conditioning apparatus; carpentry services; cleaning services; housekeeping services; cleaning and maintenance; window cleaning; vehicle service stations; vehicle repair; information, advice and consultancy services relating to the aforesaid), 39(Transportation services by land, sea and air; air transport; aircraft rental; rental of aircraft engines; ambulance transport; barge transport; boat rental; boat storage; boat transport; booking of seats for travel; bottling services; bus transport; car parking; car rental; car sharing services; car transport; Carting; chauffeur services; collection of recyclable goods [transport]; courier services [messages or merchandise]; arranging of cruises; delivery of goods; delivery of goods by mail order; distribution of energy; rental of diving bells; rental of diving suits; providing driving directions for travel purposes; escorting of travellers; ferry-boat transport; freight [shipping of goods]; freight brokerage [forwarding (Am.)] / freight brokerage; freight forwarding; Freighting; garage rental; guarded transport of valuables; providing information relating to storage services; marine transport; motor coach rental; rental of motor racing cars; rental of navigational systems; packaging of goods; parcel delivery; parking place rental; passenger transport; pleasure boat transport; Porterage; railway coach rental; railway transport; railway truck rental; refloating of ships; removal services; rescue operations [transport]; river transport; rental of storage containers; storage / warehousing; storage of goods; taxi transport; tram transport / streetcar transport; Transport; transport and storage of waste / transport and storage of trash; transport brokerage; transport by pipeline; transport of travellers; transport reservation; transport services for sightseeing tours; arranging of transportation for travel tours; providing transportation information; transportation logistics; transporting furniture; travel reservation; unloading cargo; vehicle breakdown towing services; vehicle rental; rental of warehouses;

water distribution; water supplying; wrapping of goods; packaging and storage of goods; travel arrangement; air transport; aircraft rental; boat rental; boat storage; boat transport; booking of seats for travel; bus transport; car parking; car rental; car transport; chauffeur services; arranging of cruises; delivery of goods; escorting of travellers; freight [shipping of goods]; garage rental; marine transport; luggage storage; rental of navigational systems; arranging of passenger transportation services for others via an online application; passenger transport; pleasure boat transport; taxi transport; transport reservation; transport of travellers; arranging travel tours; arranging for travel visas and travel documents for persons travelling abroad; travel reservation; vehicle rental; transport services for sightseeing tours; arranging of transportation for travel tours; providing transport information; sightseeing [tourism]; tourist guide services; arranging excursions for tourists; organisation of travel; providing tourist information via the internet; tourist travel reservation services; providing information to tourists relating to excursions and sightseeing; information, advice and consultancy services relating to the aforesaid), 40(Abrasion; air deodorizing / air deodorizing; air freshening; air purification; rental of air-conditioning apparatus; cloth cutting; cloth dyeing; cloth edging; colour separation services; crease-resistant treatment for clothing; custom assembling of materials for others; decontamination of hazardous materials; destruction of waste and trash; production of energy; rental of generators; incineration of waste and trash; providing information relating to material treatment; planning of materials; processing of cinematographic films; processing of oil; recycling of waste and trash; refining services; sorting of waste and recyclable material [transformation]; rental of space heating apparatus; stripping finishes; up cycling [waste recycling]; vulcanization [material treatment]; waste treatment [transformation]; water treating; welding services; treatment of materials; soil, waste, organic matter or water treatment services; environmental remediation services; treatment of waste materials and organic matter in the field of environmental pollution control; water conditioning and purification; recycling, waste material and organic matter treatment; recycling services; waste materials and organic matter destruction; waste materials and organic matter management; waste reduction; providing information regarding waste materials and organic matter management, reduction, treatment and recycling; consultancy in relation to waste management, reduction, treatment and recycling; decontamination, depollution and sanitation services for industrial installations and sites, equipment and apparatus; rental of apparatus and installations for generating energy in all forms and providing of information relating thereto; rental of chemical treatment apparatus and installations and provision of information relating thereto; air purification; purification, decontamination and depollution services for air, water and soil; air freshening; timber processing services; timber felling services; treatment of timber; processing of agricultural products; transformation and treatment of all materials for energy production; processing services of natural elements (sun, water, wind) into energy; treatment, recycling and disposal of waste and organic matter; refining; sandblasting; metal treatment; processing and refinement of fuel materials; cloth cutting; custom assembling of materials for others; information, advice and consultancy services relating to the aforesaid.), 41(Education; training; arranging, hosting and conducting seminars, workshops, classes, conferences, and symposiums; academies [education]; amusement park services; providing amusement arcade services; animal training; rental of artwork; rental of audio equipment; arranging of beauty contests; booking of seats for shows; cinema

presentations /movie theatre presentations; rental of cinematographic apparatus; club services [entertainment or education]; coaching [training]; arranging and conducting of colloquiums; organization of competitions [education or entertainment]; arranging and conducting of concerts; arranging and conducting of conferences; arranging and conducting of congresses; disc jockey services; electronic desktop publishing; entertainer services; entertainment services; organization of exhibitions for cultural or educational purposes; organization of fashion shows for entertainment purposes; film production, other than advertising films; providing films, not downloadable, via video-on-demand services; conducting fitness classes; providing golf facilities; conducting guided tours; gymnastic instruction; health club services [health and fitness training]; holiday camp services [entertainment]; arranging and conducting of in-person educational forums; rental of indoor aquaria; providing information in the field of education; providing information in the field of entertainment; providing information relating to recreational activities; karaoke services; layout services, other than for advertising purposes; lending library services; rental of lighting apparatus for theatrical sets or television studios; Microfilming; mobile library services / bookmobile services; modelling for artists; rental of motion pictures; movie studio services; providing museum facilities [presentation, exhibitions]; music composition services; production of music; news reporters services; nursery schools; online publication of electronic books and journals; providing online electronic publications, not downloadable; providing online music, not downloadable; providing online videos, not downloadable; party planning [entertainment]; personal trainer services [fitness training]; photographic reporting; Photography; physical education; practical training [demonstration]; presentation of circus performances; presentation of live performances; presentation of variety shows; publication of books; publication of texts, other than publicity texts; production of radio and television programmes; radio entertainment; rental of radio and television sets; recording studio services; providing recreation facilities; arranging and conducting of seminars; rental of show scenery; organization of shows [impresario services]; production of shows; rental of skin diving equipment; Songwriting; rental of sound recordings; sport camp services; organization of sports competitions; providing sports facilities; rental of sports equipment, except vehicles; rental of ~ports grounds; rental of stadium facilities; rental of stage scenery;; arranging and conducting of symposiums; teaching /educational services /instruction services; television entertainment; rental of tennis courts; theatre productions; ticket agency services [entertainment]; timing of sports events; toy rental; training services provided via simulators; Translation; Tutoring; rental of video cameras / rental of camcorders; rental of video cassette recorders; videotape editing; rental of videotapes; Videotaping; vocational guidance [education or training advice]; vocational retraining; arranging and conducting of workshops [training]; writing of texts*; zoological garden services; booking of seats for shows; cinema presentations; club services [entertainment or education]; coaching [training]; arranging and conducting of concerts; arranging and conducting of conferences; arranging and conducting of congresses; cultural, educational or entertainment services provided by art galleries; discotheque services; electronic desktop publishing; organisation of exhibitions for cultural or educational purposes; film production, other than advertising films; game services provided online from a computer network; games equipment rental; conducting fitness classes; providing golf facilities; conducting guided tours; health club services [health and fitness training]; holiday camp services [entertainment]; providing

information in the field of entertainment; online publication of electronic books and journals; providing online electronic publications, not downloadable; providing online music, not downloadable; providing online videos, not downloadable; party planning [entertainment]; photography; presentation of live performances; providing recreation facilities; providing user reviews for entertainment or cultural purposes; providing tennis facilities; providing swimming pool facilities; providing leisure facilities; providing entertainment facilities; scuba diving services; water sports services; marine park services; aquarium services; zoos; animal conservation services; museums; theme parks; zoological gardens; educational services relating to environmental conservation; provision of information in relation to all these services; advisory consultancy and information services relating to the aforesaid services), 43(Accommodation bureau services [hotels, boarding houses]; boarding for animals; boarding house bookings; boarding house services; cafe services; cafeteria services; providing campground facilities; canteen services; rental of chairs, tables, table linen, glassware; rental of cooking apparatus; day-nursery [creche] services; rental of drinking water dispensers; food and drink catering; food sculpting; holiday camp services [lodging]; hotel reservations; hotel services; rental of lighting apparatus*; rental of meeting rooms; motel services; reception services for temporary accommodation [management of arrivals and departures]; restaurant services; self-service restaurant services; snack-bar services; rental of temporary accommodation; temporary accommodation reservations; rental of tents; tourist home services; rental of transportable buildings*; services for providing food and drink; temporary accommodation; reservation, booking and information services relating to hotels and temporary accommodation; serviced apartment services [accommodation]; provision of event facilities for conferences, meetings, exhibitions, training sessions, workshops, business fairs, congresses and lectures; hospitality services [accommodation/ food and drink]; restaurants; self-service restaurants; takeaway restaurants; coffee shop services; cafe services; snack-bar services; catering for the provision of food and beverages; accommodation bureau services [hotels, boarding houses]; boarding house bookings; boarding house services; cafeteria services; canteen services; hookah lounge services; rental of meeting rooms; personal chef services; rental of tents; reception services for temporary accommodation [management of arrivals and departures]; rental of transportable buildings; advisory consultancy and information services relating to the aforesaid services.) and 44(Medical services; hospital services; medical clinic services; nursing home services; veterinary services; hygienic and beauty care for human beings or animals; agriculture, aquaculture, horticulture and forestry services; aroma therapy services; beauty salon services; cultivation of plants; dietary and nutritional advice; flower arranging; gardening; hairdressing; health care; health centre services; health spa services; landscape design; landscape gardening; landscape design; massage; medical clinic services; nursing home services; dentist services; optician services; sauna services; solarium services; Turkish bath services; aquaculture services; health and relaxation resort services; health, fitness and medical information services; beauty and skin care services; massage services; cosmetic treatment services; provision of tanning services and facilities; provision of manicure and pedicure services; advisory consultancy; aroma therapy services; beauty salon services; health spa services; sauna services; health and relaxation resort services; health, fitness and medical information services; dentistry services; hairdressing; health care; health centre services / health centre services; hospital services; pest control services for agriculture, aquaculture,

horticulture and forestry; wildlife conservation services; agricultural services relating to environmental conservation; animal breeding; animal farming; animal healthcare services; sustainable agriculture, aquaculture and horticulture services; nursery services; landscape nurseries; forestry management; forest design and maintenance; agricultural services relating to environmental conservation; agriculture, horticulture and forestry services; planting of trees for carbon off setting purposes; cultivation of plants; landscape architecture services; gardening; planting and growing of trees and plants; tree nursery services; tree surgery services; farming equipment rental; advisory consultancy and information services relating to the aforesaid services.) (526): None (730): HIFD INTELLECTUAL PROPERTY COMPANY (A SINGLE SHAREHOLDER LIMITED LIABILITY COMPANY) of 5th Floor, Tower MU04, AlRaidah Digital City Complex, Al Nakhil District 3807, Riyadh, 12383-6726, Saudi Arabia (740): CFL Advocates of P.O. Box 23555 - 00100, Nairobi, Kenya

(210): 126360 (220): 06/02/2023

(300): None (511): 35(Administration of consumer loyalty programs; loyalty, incentive and bonus program services; membership program enabling participants to receive discounts and special promotions on hotels rooms and temporary lodging; administration of consumer loyalty programs; administration of frequent flyer programs; organization, operation and supervision of sales and promotional incentive schemes; administration of frequent flyer programs; administrative services for the relocation of businesses; advertising / publicity; advertising agency services / publicity agency services; advertising by mail order; production of advertising films; bill-posting; business auditing; business inquiries; business intermediary services relating to the matching of potential private investors with entrepreneurs needing funding; business management and organization consultancy; business management assistance; business management consultancy; business management of hotels; business management of reimbursement programmes for others / business management of reimbursement programs for others; business organization consultancy; business project management services for construction projects; providing business information; providing business information via a website; commercial administration of the licensing of the goods and services of others; commercial intermediation services; commercial or industrial management assistance; providing commercial and business contact information; providing commercial information and advice for consumers in the choice of products and services; compilation of information into computer databases; cost price analysis; demonstration of goods; development of advertising concepts; direct mail advertising; dissemination of advertising matter; economic forecasting; organization of exhibitions for commercial or advertising purposes; organization of fashion shows for promotional purposes; market studies; Marketing; marketing research; negotiation and conclusion of commercial transactions for third parties; negotiation of business contracts for others; online advertising on a computer network; outsourced administrative management for companies; outsourcing services . [business assistance]; personnel recruitment; presentation of goods on communication media, for retail purposes; procurement services for others [purchasing goods and services for other businesses]; public relations; publication of publicity texts; radio advertising; rental of sales stands; sales promotion for others; search engine optimization for sales promotion / search engine optimization for sales promotion; sponsorship search; arranging subscriptions to telecommunication services for others; systemization of information into computer databases; telemarketing services; television advertising; organization of trade fairs; updating and maintenance of

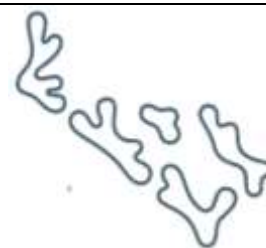

data in computer databases; updating and maintenance of information in registries; updating of advertising material; web indexing for commercial or advertising purposes; writing of publicity texts; advertising services to promote public awareness of environmental matters and environmental sustainability; management of retail malls and retail outlets; wholesale, online retail and in-store retail services relating to the sale of souvenirs, clothing, footwear, headgear, cosmetics, skincare, candles, perfumes, jewelry, sports and leisure equipment, books, photographs and stationery; business management of tourism destinations and resorts; business management of hotels; administrative hotel management; advertising in the field of tourism; information, consultancy and advice relating to the aforesaid.), 36(Accommodation bureau services [apartments]; apartment house management; rental of apartments; brokerage*; capital investment; charitable fund raising; arranging finance for construction projects; financial analysis; financial consultancy; financial evaluation [insurance, banking, real estate]; financial management; financial sponsorship; providing financial information; financing services; insurance brokerage; insurance consultancy; insurance underwriting; providing insurance information; investment of funds; loans [financing]; rental of offices [real estate]; processing of credit card payments; processing of debit card payments; real estate agency services; real estate appraisal; real estate brokerage; real estate management; rental of real estate; issuance of tokens of value; issuance of travellers' cheques / issuance of travelers' checks; issuance of tokens of value; issuance of gift vouchers; management of real estate destinations and resorts; property portfolio management; land acquisition services; real estate services relating to the management of land; commercial investment services; property and real estate investment services; real estate investment trust management services; real estate brokerage, management, leasing and letting services; estate agency and property letting services; rental of permanent accommodation; rent collection services; management of rental property; services relating to the provision of finance for the purchase of buildings, homes, real estate and land; information, advice and consultancy services relating to the aforesaid.), 37(Construction services; land development services; airplane maintenance and repair; boiler cleaning and repair; Bricklaying; building construction supervision; building insulating; building of fair stalls and shops; building sealing / damp-proofing [building]; carpentry services; cleaning of buildings [exterior surface]; cleaning of buildings [interior]; rental of cleaning machines; construction consultancy; construction*; providing construction information; rental of construction equipment; rental of cranes [construction equipment]; demolition of buildings; dry cleaning; electric appliance installation and repair; furniture maintenance; furniture restoration; harbor construction; heating equipment installation and repair; providing information relating to repairs; installation and repair of air-conditioning apparatus; installation of doors and windows; irrigation devices installation and repair; laying of cable; machinery installation, maintenance and repair; Masonry; office machines and equipment installation, maintenance and repair; painting or repair of signs; painting, interior and exterior; pest control services, other than for agriculture, aquaculture, horticulture and forestry; pipeline construction and maintenance; Plastering; Plumbing; road paving; roofing services; Sanding; Scaffolding; swimming-pool maintenance; underwater construction; underwater repair; vehicle maintenance; vehicle polishing; vehicle service stations [refueling and maintenance]; vehicle washing; warehouse construction and repair; window cleaning; land development services; construction services;

construction supervision; demolition services; roofing; building sealing; bricklaying; building insulating; pipeline construction; marine constructions; offshore construction; building maintenance; harbour and port construction; airport construction; construction of roads; construction of bridges; construction consultancy; construction information; building of stalls and shops at fairs; rental of construction equipment; maintenance services; maintenance of property; maintenance of buildings; maintenance of roads; maintenance of ports and harbours; maintenance of buildings; pipeline maintenance; maintenance of machinery; maintenance of vehicles; aeroplanes maintenance; building cleaning; furniture maintenance; building restoration; restoration of construction projects; installation services including in relation to appliances, plumbing, pipelines, electric cables, solar power, hydraulic power, hangers, elevators, engines, refrigerators; heating equipment installation; installation of air-conditioning apparatus; carpentry services; cleaning services; housekeeping services; cleaning and maintenance; window cleaning; vehicle service stations; vehicle repair; information, advice and consultancy services relating to the aforesaid.), 39(Transportation services by land, sea and air; air transport; aircraft rental; rental of aircraft engines; ambulance transport; barge transport; boat rental; boat storage; boat transport; booking of seats for travel; bottling services; bus transport; car parking; car rental; car sharing services; car transport; Carting; chauffeur services; collection of recyclable goods [transport]; courier services [messages or merchandise]; arranging of cruises; delivery of goods; delivery of goods by mail order; distribution of energy; rental of diving bells; rental of diving suits; providing driving directions for travel purposes; escorting of travellers; ferry-boat transport; freight [shipping of goods]; freight brokerage [forwarding (Am.)] / freight brokerage; freight forwarding; Freightage; garage rental; guarded transport of valuables; providing information relating to storage services; marine transport; motor coach rental; rental of motor racing cars; rental of navigational systems; packaging of goods; parcel delivery; parking place rental; passenger transport; pleasure boat transport; Porterage; railway coach rental; railway transport; railway truck rental; refloating of ships; removal services; rescue operations [transport]; river transport; rental of storage containers; storage / warehousing; storage of goods; taxi transport; tram transport / streetcar transport; Transport; transport and storage of waste / transport and storage of trash; transport brokerage; transport by pipeline; transport of travellers; transport reservation; transport services for sightseeing tours; arranging of transportation for travel tours; providing transportation information; transportation logistics; transporting furniture; travel reservation; unloading cargo; vehicle breakdown towing services; vehicle rental; rental of warehouses; water distribution; water supplying; wrapping of goods; packaging and storage of goods; travel arrangement; air transport; aircraft rental; boat rental; boat storage; boat transport; booking of seats for travel; bus transport; car parking; car rental; car transport; chauffeur services; arranging of cruises; delivery of goods; escorting of travellers; freight [shipping of goods]; garage rental; marine transport; luggage storage; rental of navigational systems; arranging of passenger transportation services for others via an online application; passenger transport; pleasure boat transport; taxi transport; transport reservation; transport of travellers; arranging travel tours; arranging for travel visas and travel documents for persons travelling abroad; travel reservation; vehicle rental; transport services for sightseeing tours; arranging of transportation for travel tours; providing transport information; sightseeing [tourism]; tourist guide services; arranging excursions for tourists;

organisation of travel; providing tourist information via the internet; tourist travel reservation services; providing information to tourists relating to excursions and sightseeing; information, advice and consultancy services relating to the aforesaid.), 40(Abrasion; air deodorizing / air deodorizing; air freshening; air purification; rental of air- conditioning apparatus; cloth cutting; cloth dyeing; cloth edging; colour separation services; crease-resistant treatment for clothing; custom assembling of materials for others; decontamination of hazardous materials; destruction of waste and trash; production of energy; rental of generators; incineration of waste and trash; providing information relating to material treatment; planning of materials; processing of cinematographic films; processing of oil; recycling of waste and trash; refining services; sorting of waste and recyclable material [transformation]; rental of space heating apparatus; stripping finishes; up cycling [waste recycling]; vulcanization [material treatment]; waste treatment [transformation]; water treating; welding services; treatment of materials; soil, waste, organic matter or water treatment services; environmental remediation services; treatment of waste materials and organic matter in the field of environmental pollution control; water conditioning and purification; recycling, waste material and organic matter treatment; recycling services; waste materials and organic matter destruction; waste materials and organic matter management; waste reduction; providing information regarding waste materials and organic matter management, reduction, treatment and recycling; consultancy in relation to waste management, reduction, treatment and recycling; decontamination, depollution and sanitation services for industrial installations and sites, equipment and apparatus; rental of apparatus and installations for generating energy in all forms and providing of information relating thereto; rental of chemical treatment apparatus and installations and provision of information relating thereto; air purification; purification, decontamination and depollution services for air, water and soil; air freshening; timber processing services; timber felling services; treatment of timber; processing of agricultural products; transformation and treatment of all materials for energy production; processing services of natural elements (sun, water, wind) into energy; treatment, recycling and disposal of waste and organic matter; refining; sandblasting; metal treatment; processing and refinement of fuel materials; cloth cutting; custom assembling of materials for others; information, advice and consultancy services relating to the aforesaid.), 41(Education; training; arranging, hosting and conducting seminars, workshops, classes, conferences, and symposiums; academies [education]; amusement park services; providing amusement arcade services; animal training; rental of artwork; rental of audio equipment; arranging of beauty contests; booking of seats for shows; cinema presentations / movie theatre presentations; rental of cinematographic apparatus; club services [entertainment or education]; coaching [training]; arranging and conducting of colloquiums; organization of competitions [education or entertainment]; arranging and conducting of concerts; arranging and conducting of conferences; arranging and conducting of congresses; disc jockey services; electronic desktop publishing; entertainer services; entertainment services; organization of exhibitions for cultural or educational purposes; organization of fashion shows for entertainment purposes; film production, other than advertising films; providing films, not downloadable, via video-on-demand services; conducting fitness classes; providing golf facilities; conducting guided tours; gymnastic instruction; health club services [health and fitness training]; holiday camp services [entertainment]; arranging and conducting of in-person educational forums; rental of

indoor aquaria; providing information in the field of education; providing information in the field of entertainment; providing information relating to recreational activities; karaoke services; layout services, other than for advertising purposes; lending library services; rental of lighting apparatus for theatrical sets or television studios; Microfilming; mobile library services / bookmobile services; modelling for artists; rental of motion pictures; movie studio services; providing museum facilities [presentation, exhibitions]; music composition services; production of music; news reporters services; nursery schools; online publication of electronic books and journals; providing online electronic publications, not downloadable; providing online music, not downloadable; providing online videos, not downloadable; party planning [entertainment]; personal trainer services [fitness training]; photographic reporting; Photography; physical education; practical training [demonstration]; presentation of circus performances; presentation of live performances; presentation of variety shows; publication of books; publication of texts, other than publicity texts; production of radio and television programmes; radio entertainment; rental of radio and television sets; recording studio services; providing recreation facilities; arranging and conducting of seminars; rental of show scenery; organization of shows [impresario services]; production of shows; rental of skin diving equipment; Songwriting; rental of sound recordings; sport camp services; organization of sports competitions; providing sports facilities; rental of sports equipment, except vehicles; rental of ~ports grounds; rental of stadium facilities; rental of stage scenery;; arranging and conducting of symposiums; teaching / educational services / instruction services; television entertainment; rental of tennis courts; theatre productions; ticket agency services [entertainment]; timing of sports events; toy rental; training services provided via simulators; Translation; Tutoring; rental of video cameras / rental of camcorders; rental of video cassette recorders; videotape editing; rental of videotapes; Videotaping; vocational guidance [education or training advice]; vocational retraining; arranging and conducting of workshops [training]; writing of texts*; zoological garden services; booking of seats for shows; cinema presentations; club services [entertainment or education]; coaching [training]; arranging and conducting of concerts; arranging and conducting of conferences; arranging and conducting of congresses; cultural, educational or entertainment services provided by art galleries; discotheque services; electronic desktop publishing; organisation of exhibitions for cultural or educational purposes; film production, other than advertising films; game services provided online from a computer network; games equipment rental; conducting fitness classes; providing golf facilities; conducting guided tours; health club services [health and fitness training]; holiday camp services [entertainment]; providing information in the field of entertainment; online publication of electronic books and journals; providing online electronic publications, not downloadable; providing online music, not downloadable; providing online videos, not downloadable; party planning [entertainment]; photography; presentation of live performances; providing recreation facilities; providing user reviews for entertainment or cultural purposes; providing tennis facilities; providing swimming pool facilities; providing leisure facilities; providing entertainment facilities; scuba diving services; water sports services; marine park services; aquarium services; zoos; animal conservation services; museums; theme parks; zoological gardens; educational services relating to environmental conservation; provision of information in relation to all these services; advisory consultancy and information services relating to the aforesaid services), 43(Accommodation bureau services [hotels,

boarding houses]; boarding for animals; boarding house bookings; boarding house services; cafe services; cafeteria services; providing campground facilities; canteen services; rental of chairs, tables, table linen, glassware; rental of cooking apparatus; day-nursery [creche] services; rental of drinking water dispensers; food and drink catering; food sculpting; holiday camp services [lodging]; hotel reservations; hotel services; rental of lighting apparatus*; rental of meeting rooms; motel services; reception services for temporary accommodation [management of arrivals and departures]; restaurant services; self-service restaurant services; snack-bar services; rental of temporary accommodation; temporary accommodation reservations; rental of tents; tourist home services; rental of transportable buildings*; services for providing food and drink; temporary accommodation; reservation, booking and information services relating to hotels and temporary accommodation; serviced apartment services [accommodation]; provision of event facilities for conferences, meetings, exhibitions, training sessions, workshops, business fairs, congresses and lectures; hospitality services [accommodation/ food and drink]; restaurants; self-service restaurants; takeaway restaurants; coffee shop services; cafe services; snack-bar services; catering for the provision of food and beverages; accommodation bureau services [hotels, boarding houses]; boarding house bookings; boarding house services; cafeteria services; canteen services; hookah lounge services; rental of meeting rooms; personal chef services; rental of tents; reception services for temporary accommodation [management of arrivals and departures]; rental of transportable buildings; advisory consultancy and information services relating to the aforesaid services) and 44(Medical services; hospital services; medical clinic services; nursing home services; veterinary services; hygienic and beauty care for human beings or animals; agriculture, aquaculture, horticulture and forestry services; aroma therapy services; beauty salon services; cultivation of plants; dietary and nutritional advice; flower arranging; gardening; hairdressing; health care; health centre services; health spa services; landscape design; landscape gardening; landscape design; massage; medical clinic services; nursing home services; dentist services; optician services; sauna services; solarium services; Turkish bath services; aquaculture services; health and relaxation resort services; health, fitness and medical information services; beauty and skin care services; massage services; cosmetic treatment services; provision of tanning services and facilities; provision of manicure and pedicure services; advisory consultancy; aroma therapy services; beauty salon services; health spa services; sauna services; health and relaxation resort services; health, fitness and medical information services; dentistry services; hairdressing; health care; health centre services / health centre services; hospital services; pest control services for agriculture, aquaculture, horticulture and forestry; wildlife conservation services; agricultural services relating to environmental conservation; animal breeding; animal farming; animal healthcare services; sustainable agriculture, aquaculture and horticulture services; nursery services; landscape nurseries; forestry management; forest design and maintenance; agricultural services relating to environmental conservation; agriculture, horticulture and forestry services; planting of trees for carbon off setting purposes; cultivation of plants; landscape architecture services; gardening; planting and growing of trees and plants; tree nursery services; tree surgery services; farming

equipment rental; advisory consultancy and information services relating to the aforesaid services.) **(526):** None **(730):** HIFD INTELLECTUAL PROPERTY COMPANY (A SINGLE SHAREHOLDER LIMITED LIABILITY COMPANY) of 5th Floor, Tower MU04, AlRaidah Digital City Complex, Al Nakhil District 3807, Riyadh, 12383-6726., Saudi Arabia **(740):** CFL ADVOCATES, P. O. BOX 23555 - 00100, Nairobi, Kenya

(210): 126361 **(220):** 06/02/2023 **(300):** None **(511):** 35(Administration of consumer loyalty programs; loyalty, incentive and bonus program services; membership program enabling participants to receive discounts and special promotions on hotels rooms and temporary lodging; administration of consumer loyalty programs; administration of frequent flyer programs; organization, operation and supervision of sales and promotional incentive schemes; administration of frequent flyer programs; administrative services for the relocation of businesses; advertising / publicity; advertising agency services / publicity agency services; advertising by mail order; production of advertising films; bill-posting; business auditing; business inquiries; business intermediary services relating to the matching of potential private investors with entrepreneurs needing funding; business management and organization consultancy; business management assistance; business management consultancy; business management of hotels; business management of reimbursement programmes for others / business management of reimbursement programs for others; business organization consultancy; business project management services for construction projects; providing business information; providing business information via a website; commercial administration of the licensing of the goods and services of others; commercial intermediation services; commercial or industrial management assistance; providing commercial and business contact information; providing commercial information and advice for consumers in the choice of products and services; compilation of information into computer databases; cost price analysis; demonstration of goods; development of advertising concepts; direct mail advertising; dissemination of advertising matter; economic forecasting; organization of exhibitions for commercial or advertising purposes; organization of fashion shows for promotional purposes; market studies; Marketing; marketing research; negotiation and conclusion of commercial transactions for third parties; negotiation of business contracts for others; online advertising on a computer network; outsourced administrative management for companies; outsourcing services . [business assistance]; personnel recruitment; presentation of goods on communication media, for retail purposes; procurement services for others [purchasing goods and services for other businesses]; public relations; publication of publicity texts; radio advertising; rental of sales stands; sales promotion for others; search engine optimization for sales promotion / search engine optimization for sales promotion; sponsorship search; arranging subscriptions to telecommunication services for others; systemization of information into computer databases; telemarketing services; television advertising; organization of trade fairs; updating and maintenance of data in computer databases; updating and maintenance of information in registries; updating of advertising material; web indexing for commercial or advertising purposes; writing of publicity texts; advertising services to promote public awareness of environmental matters and environmental sustainability; management of retail malls and retail outlets; wholesale, online retail and in-store retail services relating to the sale of souvenirs, clothing, footwear, headgear, cosmetics, skincare, candles, perfumes, jewelry, sports and leisure equipment, books,



photographs and stationery; business management of tourism destinations and resorts; business management of hotels; administrative hotel management; advertising in the field of tourism; information, consultancy and advice relating to the aforesaid.), 36(Accommodation bureau services [apartments]; apartment house management; rental of apartments; brokerage*; capital investment; charitable fund raising; arranging finance for construction projects; financial analysis; financial consultancy; financial evaluation [insurance, banking, real estate]; financial management; financial sponsorship; providing financial information; financing services; insurance brokerage; insurance consultancy; insurance underwriting; providing insurance information; investment of funds; loans [financing]; rental of offices [real estate]; processing of credit card payments; processing of debit card payments; real estate agency services; real estate appraisal; real estate brokerage; real estate management; rental of real estate; issuance of tokens of value; issuance of travellers' cheques / issuance of travelers' checks; issuance of tokens of value; issuance of gift vouchers; management of real estate destinations and resorts; property portfolio management; land acquisition services; real estate services relating to the management of land; commercial investment services; property and real estate investment services; real estate investment trust management services; real estate brokerage, management, leasing and letting services; estate agency and property letting services; rental of permanent accommodation; rent collection services; management of rental property; services relating to the provision of finance for the purchase of buildings, homes, real estate and land; information, advice and consultancy services relating to the aforesaid.), 37(Construction services; land development services; airplane maintenance and repair; boiler cleaning and repair; Bricklaying; building construction supervision; building insulating; building of fair stalls and shops; building sealing / damp-proofing [building]; carpentry services; cleaning of buildings [exterior surface]; cleaning of buildings [interior]; rental of cleaning machines; construction consultancy; construction*; providing construction information; rental of construction equipment; rental of cranes [construction equipment]; demolition of buildings; dry cleaning; electric appliance installation and repair; furniture maintenance; furniture restoration; harbor construction; heating equipment installation and repair; providing information relating to repairs; installation and repair of air-conditioning apparatus; installation of doors and windows; irrigation devices installation and repair; laying of cable; machinery installation, maintenance and repair; Masonry; office machines and equipment installation, maintenance and repair; painting or repair of signs; painting, interior and exterior; pest control services, other than for agriculture, aquaculture, horticulture and forestry; pipeline construction and maintenance; Plastering; Plumbing; road paving; roofing services; Sanding; Scaffolding; swimming-pool maintenance; underwater construction; underwater repair; vehicle maintenance; vehicle polishing; vehicle service stations [refueling and maintenance]; vehicle washing; warehouse construction and repair; window cleaning; land development services; construction services ; construction supervision; demolition services; roofing; building sealing; bricklaying; building insulating; pipeline construction; marine constructions; offshore construction; building maintenance; harbour and port construction; airport construction; construction of roads; construction of bridges; construction consultancy; construction information; building of stalls and shops at fairs; rental of construction equipment; maintenance services; maintenance of property; maintenance of buildings; maintenance of roads;

maintenance of ports and harbours; maintenance of buildings; pipeline maintenance; maintenance of machinery; maintenance of vehicles; aeroplanes maintenance; building cleaning; furniture maintenance; building restoration; restoration of construction projects; installation services including in relation to appliances, plumbing, pipelines, electric cables, solar power, hydraulic power, hangers, elevators, engines, refrigerators; heating equipment installation; installation of air-conditioning apparatus; carpentry services; cleaning services; housekeeping services; cleaning and maintenance; window cleaning; vehicle service stations; vehicle repair; information, advice and consultancy services relating to the aforesaid.), 39(Transportation services by land, sea and air; air transport; aircraft rental; rental of aircraft engines; ambulance transport; barge transport; boat rental; boat storage; boat transport; booking of seats for travel; bottling services; bus transport; car parking; car rental; car sharing services; car transport; Carting; chauffeur services; collection of recyclable goods [transport]; courier services [messages or merchandise]; arranging of cruises; delivery of goods; delivery of goods by mail order; distribution of energy; rental of diving bells; rental of diving suits; providing driving directions for travel purposes; escorting of travellers; ferry-boat transport; freight [shipping of goods]; freight brokerage [forwarding (Am.)] / freight brokerage; freight forwarding; Freightage; garage rental; guarded transport of valuables; providing information relating to storage services; marine transport; motor coach rental; rental of motor racing cars; rental of navigational systems; packaging of goods; parcel delivery; parking place rental; passenger transport; pleasure boat transport; Porterage; railway coach rental; railway transport; railway truck rental; refloating of ships; removal services; rescue operations [transport]; river transport; rental of storage containers; storage / warehousing; storage of goods; taxi transport; tram transport / streetcar transport; Transport; transport and storage of waste / transport and storage of trash; transport brokerage; transport by pipeline; transport of travellers; transport reservation; transport services for sightseeing tours; arranging of transportation for travel tours; providing transportation information; transportation logistics; transporting furniture; travel reservation; unloading cargo; vehicle breakdown towing services; vehicle rental; rental of warehouses; water distribution; water supplying; wrapping of goods; packaging and storage of goods; travel arrangement; air transport; aircraft rental; boat rental; boat storage; boat transport; booking of seats for travel; bus transport; car parking; car rental; car transport; chauffeur services; arranging of cruises; delivery of goods; escorting of travellers; freight [shipping of goods]; garage rental; marine transport; luggage storage; rental of navigational systems; arranging of passenger transportation services for others via an online application; passenger transport; pleasure boat transport; taxi transport; transport reservation; transport of travellers; arranging travel tours; arranging for travel visas and travel documents for persons travelling abroad; travel reservation; vehicle rental; transport services for sightseeing tours; arranging of transportation for travel tours; providing transport information; sightseeing [tourism]; tourist guide services; arranging excursions for tourists; organisation of travel; providing tourist information via the internet; tourist travel reservation services; providing information to tourists relating to excursions and sightseeing; information, advice and consultancy services relating to the aforesaid.), 40(Abrasion; air deodorizing / air deodorizing; air freshening; air purification; rental of air- conditioning apparatus; cloth cutting; cloth dyeing; cloth edging; colour separation services; crease-resistant treatment for

clothing; custom assembling of materials for others; decontamination of hazardous materials; destruction of waste and trash; production of energy; rental of generators; incineration of waste and trash; providing information relating to material treatment; planning of materials; processing of cinematographic films; processing of oil; recycling of waste and trash; refining services; sorting of waste and recyclable material [transformation]; rental of space heating apparatus; stripping finishes; up cycling [waste recycling]; vulcanization [material treatment]; waste treatment [transformation]; water treating; welding services; treatment of materials; soil, waste, organic matter or water treatment services; environmental remediation services; treatment of waste materials and organic matter in the field of environmental pollution control; water conditioning and purification; recycling, waste material and organic matter treatment; recycling services; waste materials and organic matter destruction; waste materials and organic matter management; waste reduction; providing information regarding waste materials and organic matter management, reduction, treatment and recycling; consultancy in relation to waste management, reduction, treatment and recycling; decontamination, depollution and sanitation services for industrial installations and sites, equipment and apparatus; rental of apparatus and installations for generating energy in all forms and providing of information relating thereto; rental of chemical treatment apparatus and installations and provision of information relating thereto; air purification; purification, decontamination and depollution services for air, water and soil; air freshening; timber processing services; timber felling services; treatment of timber; processing of agricultural products; transformation and treatment of all materials for energy production; processing services of natural elements (sun, water, wind) into energy; treatment, recycling and disposal of waste and organic matter; refining; sandblasting; metal treatment; processing and refinement of fuel materials; cloth cutting; custom assembling of materials for others; information, advice and consultancy services relating to the aforesaid.), 41(Education; training; arranging, hosting and conducting seminars, workshops, classes, conferences, and symposiums; academies [education]; amusement park services; providing amusement arcade services; animal training; rental of artwork; rental of audio equipment; arranging of beauty contests; booking of seats for shows; cinema presentations / movie theatre presentations; rental of cinematographic apparatus; club services [entertainment or education]; coaching [training]; arranging and conducting of colloquiums; organization of competitions [education or entertainment]; arranging and conducting of concerts; arranging and conducting of conferences; arranging and conducting of congresses; disc jockey services; electronic desktop publishing; entertainer services; entertainment services; organization of exhibitions for cultural or educational purposes; organization of fashion shows for entertainment purposes; film production, other than advertising films; providing films, not downloadable, via video-on-demand services; conducting fitness classes; providing golf facilities; conducting guided tours; gymnastic instruction; health club services [health and fitness training]; holiday camp services [entertainment]; arranging and conducting of in-person educational forums; rental of indoor aquaria; providing information in the field of education; providing information in the field of entertainment; providing information relating to recreational activities; karaoke services; layout services, other than for advertising purposes; lending library services; rental of lighting apparatus for theatrical sets or television studios; Microfilming; mobile library services / bookmobile services; modelling for artists; rental of motion pictures; movie studio

services; providing museum facilities [presentation, exhibitions]; music composition services; production of music; news reporters services; nursery schools; online publication of electronic books and journals; providing online electronic publications, not downloadable; providing online music, not downloadable; providing online videos, not downloadable; party planning [entertainment]; personal trainer services [fitness training]; photographic reporting; Photography; physical education; practical training [demonstration]; presentation of circus performances; presentation of live performances; presentation of variety shows; publication of books; publication of texts, other than publicity texts; production of radio and television programmes; radio entertainment; rental of radio and television sets; recording studio services; providing recreation facilities; arranging and conducting of seminars; rental of show scenery; organization of shows [impresario services]; production of shows; rental of skin diving equipment; Songwriting; rental of sound recordings; sport camp services; organization of sports competitions; providing sports facilities; rental of sports equipment, except vehicles; rental of -ports grounds; rental of stadium facilities; rental of stage scenery;; arranging and conducting of symposiums; teaching / educational services / instruction services; television entertainment; rental of tennis courts; theatre productions; ticket agency services [entertainment]; timing of sports events; toy rental; training services provided via simulators; Translation; Tutoring; rental of video cameras / rental of camcorders; rental of video cassette recorders; videotape editing; rental of videotapes; Videotaping; vocational guidance [education or training advice]; vocational retraining; arranging and conducting of workshops [training]; writing of texts*; zoological garden services; booking of seats for shows; cinema presentations; club services [entertainment or education]; coaching [training]; arranging and conducting of concerts; arranging and conducting of conferences; arranging and conducting of congresses; cultural, educational or entertainment services provided by art galleries; discotheque services; electronic desktop publishing; organisation of exhibitions for cultural or educational purposes; film production, other than advertising films; game services provided online from a computer network; games equipment rental; conducting fitness classes; providing golf facilities; conducting guided tours; health club services [health and fitness training]; holiday camp services [entertainment]; providing information in the field of entertainment; online publication of electronic books and journals; providing online electronic publications, not downloadable; providing online music, not downloadable; providing online videos, not downloadable; party planning [entertainment]; photography; presentation of live performances; providing recreation facilities; providing user reviews for entertainment or cultural purposes; providing tennis facilities; providing swimming pool facilities; providing leisure facilities; providing entertainment facilities; scuba diving services; water sports services; marine park services; aquarium services; zoos; animal conservation services; museums; theme parks; zoological gardens; educational services relating to environmental conservation; provision of information in relation to all these services; advisory consultancy and information services relating to the aforesaid services), 43(Accommodation bureau services [hotels, boarding houses]; boarding for animals; boarding house bookings; boarding house services; cafe services; cafeteria services; providing campground facilities; canteen services; rental of chairs, tables, table linen, glassware; rental of cooking apparatus; day-nursery [creche] services; rental of drinking water dispensers; food and drink catering; food sculpting; holiday camp services [lodging]; hotel reservations; hotel services; rental of lighting apparatus*; rental of

meeting rooms; motel services; reception services for temporary accommodation [management of arrivals and departures]; restaurant services; self-service restaurant services; snack-bar services; rental of temporary accommodation; temporary accommodation reservations; rental of tents; tourist home services; rental of transportable buildings*; services for providing food and drink; temporary accommodation; reservation, booking and information services relating to hotels and temporary accommodation; serviced apartment services [accommodation]; provision of event facilities for conferences, meetings, exhibitions, training sessions, workshops, business fairs, congresses and lectures; hospitality services [accommodation/ food and drink]; restaurants; self-service restaurants; takeaway restaurants; coffee shop services; cafe services; snack-bar services; catering for the provision of food and beverages; accommodation bureau services [hotels, boarding houses]; boarding house bookings; boarding house services; cafeteria services; canteen services; hookah lounge services; rental of meeting rooms; personal chef services; rental of tents; reception services for temporary accommodation [management of arrivals and departures]; rental of transportable buildings; advisory consultancy and information services relating to the aforesaid services.) and 44(Medical services; hospital services; medical clinic services; nursing home services; veterinary services; hygienic and beauty care for human beings or animals; agriculture, aquaculture, horticulture and forestry services; aroma therapy services; beauty salon services; cultivation of plants; dietary and nutritional advice; flower arranging; gardening; hairdressing; health care; health centre services; health spa services; landscape design; landscape gardening; landscape design; massage; medical clinic services; nursing home services; dentist services; optician services; sauna services; solarium services; Turkish bath services; aquaculture services; health and relaxation resort services; health, fitness and medical information services; beauty and skin care services; massage services; cosmetic treatment services; provision of tanning services and facilities; provision of manicure and pedicure services; advisory consultancy; aroma therapy services; beauty salon services; health spa services; sauna services; health and relaxation resort services; health, fitness and medical information services; dentistry services; hairdressing; health care; health centre services / health centre services; hospital services; pest control services for agriculture, aquaculture, horticulture and forestry; wildlife conservation services; agricultural services relating to environmental conservation; animal breeding; animal farming; animal healthcare services; sustainable agriculture, aquaculture and horticulture services; nursery services; landscape nurseries; forestry management; forest design and maintenance; agricultural services relating to environmental conservation; agriculture, horticulture and forestry services; planting of trees for carbon off setting purposes; cultivation of plants; landscape architecture services; gardening; planting and growing of trees and plants; tree nursery services; tree surgery services; farming equipment rental; advisory consultancy and information services relating to the aforesaid services.) **(526):** None **(730):** HIFD INTELLECTUAL PROPERTY COMPANY (A SINGLE SHAREHOLDER LIMITED LIABILITY COMPANY) of 5th Floor, Tower MU04, AIRaidah Digital City Complex, Al Nakhil District 3807, Riyadh, 12383-6726, Saudi Arabia **(740):** CFL Advocates of P.O. Box 23555 - 00100, Nairobi, Kenya

(210): 126362 **(220):** 06/02/2023

(300): None **(511):** 35(Administration of consumer loyalty programs; loyalty, incentive and bonus program services; membership program enabling participants to receive discounts and special promotions on hotels rooms and temporary lodging; administration of consumer loyalty programs; administration of frequent flyer programs; organization, operation and supervision of sales and promotional incentive schemes; administration of frequent flyer programs; administrative services for the relocation of businesses; advertising / publicity; advertising agency services / publicity agency services; advertising by mail order; production of advertising films; bill-posting; business auditing; business inquiries; business intermediary services relating to the matching of potential private investors with entrepreneurs needing funding; business management and organization consultancy; business management assistance; business management consultancy; business management of hotels; business management of reimbursement programmes for others / business management of reimbursement programs for others; business organization consultancy; business project management services for construction projects; providing business information; providing business information via a website; commercial administration of the licensing of the goods and services of others; commercial intermediation services; commercial or industrial management assistance; providing commercial and business contact information; providing commercial information and advice for consumers in the choice of products and services; compilation of information into computer databases; cost price analysis; demonstration of goods; development of advertising concepts; direct mail advertising; dissemination of advertising matter; economic forecasting; organization of exhibitions for commercial or advertising purposes; organization of fashion shows for promotional purposes; market studies; Marketing; marketing research; negotiation and conclusion of commercial transactions for third parties; negotiation of business contracts for others; online advertising on a computer network; outsourced administrative management for companies; outsourcing services . [business assistance]; personnel recruitment; presentation of goods on communication media, for retail purposes; procurement services for others [purchasing goods and services for other businesses]; public relations; publication of publicity texts; radio advertising; rental of sales stands; sales promotion for others; search engine optimization for sales promotion / search engine optimization for sales promotion; sponsorship search; arranging subscriptions to telecommunication services for others; systemization of information into computer databases; telemarketing services; television advertising; organization of trade fairs; updating and maintenance of data in computer databases; updating and maintenance of information in registries; updating of advertising material; web indexing for commercial or advertising purposes; writing of publicity texts; advertising services to promote public awareness of environmental matters and environmental sustainability; management of retail malls and retail outlets; wholesale, online retail and in-store retail services relating to the sale of souvenirs, clothing, footwear, headgear, cosmetics, skincare, candles, perfumes, jewelry, sports and leisure equipment, books, photographs and stationery; business management of tourism destinations and resorts; business management of hotels; administrative hotel management; advertising in the field of tourism; information, consultancy and advice relating to the aforesaid.), 36(Accommodation bureau services [apartments]; apartment house management; rental of apartments; brokerage*; capital investment; charitable fund raising; arranging finance for construction projects; financial analysis; financial consultancy;



financial evaluation [insurance, banking, real estate]; financial management; financial sponsorship; providing financial information; financing services; insurance brokerage; insurance consultancy; insurance underwriting; providing insurance information; investment of funds; loans [financing]; rental of offices [real estate]; processing of credit card payments; processing of debit card payments; real estate agency services; real estate appraisal; real estate brokerage; real estate management; rental of real estate; issuance of tokens of value; issuance of travellers' cheques / issuance of travelers' checks; issuance of tokens of value; issuance of gift vouchers; management of real estate destinations and resorts; property portfolio management; land acquisition services; real estate services relating to the management of land; commercial investment services; property and real estate investment services; real estate investment trust management services; real estate brokerage, management, leasing and letting services; estate agency and property letting services; rental of permanent accommodation; rent collection services; management of rental property; services relating to the provision of finance for the purchase of buildings, homes, real estate and land; information, advice and consultancy services relating to the aforesaid.), 37(Construction services; land development services; airplane maintenance and repair; boiler cleaning and repair; Bricklaying; building construction supervision; building insulating; building of fair stalls and shops; building sealing / damp-proofing [building]; carpentry services; cleaning of buildings [exterior surface]; cleaning of buildings [interior]; rental of cleaning machines; construction consultancy; construction*; providing construction information; rental of construction equipment; rental of cranes [construction equipment]; demolition of buildings; dry cleaning; electric appliance installation and repair; furniture maintenance; furniture restoration; harbor construction; heating equipment installation and repair; providing information relating to repairs; installation and repair of air-conditioning apparatus; installation of doors and windows; irrigation devices installation and repair; laying of cable; machinery installation, maintenance and repair; Masonry; office machines and equipment installation, maintenance and repair; painting or repair of signs; painting, interior and exterior; pest control services, other than for agriculture, aquaculture, horticulture and forestry; pipeline construction and maintenance; Plastering; Plumbing; road paving; roofing services; Sanding; Scaffolding; swimming-pool maintenance; underwater construction; underwater repair; vehicle maintenance; vehicle polishing; vehicle service stations [refueling and maintenance]; vehicle washing; warehouse construction and repair; window cleaning; land development services; construction services ; construction supervision; demolition services; roofing; building sealing; bricklaying; building insulating; pipeline construction; marine constructions; offshore construction; building maintenance; harbour and port construction; airport construction; construction of roads; construction of bridges; construction consultancy; construction information; building of stalls and shops at fairs; rental of construction equipment; maintenance services; maintenance of property; maintenance of buildings; maintenance of roads; maintenance of ports and harbours; maintenance of buildings; pipeline maintenance; maintenance of machinery; maintenance of vehicles; aeroplanes maintenance; building cleaning; furniture maintenance; building restoration; restoration of construction projects; installation services including in relation to appliances, plumbing, pipelines, electric cables, solar power, hydraulic power, hangers, elevators, engines, refrigerators; heating equipment installation; installation of air-conditioning apparatus; carpentry services; cleaning services; housekeeping services; cleaning and

maintenance; window cleaning; vehicle service stations; vehicle repair; information, advice and consultancy services relating to the aforesaid.), 39(Transportation services by land, sea and air; air transport; aircraft rental; rental of aircraft engines; ambulance transport; barge transport; boat rental; boat storage; boat transport; booking of seats for travel; bottling services; bus transport; car parking; car rental; car sharing services; car transport; Carting; chauffeur services; collection of recyclable goods [transport]; courier services [messages or merchandise]; arranging of cruises; delivery of goods; delivery of goods by mail order; distribution of energy; rental of diving bells; rental of diving suits; providing driving directions for travel purposes; escorting of travellers; ferry-boat transport; freight [shipping of goods]; freight brokerage [forwarding (Am.)] / freight brokerage; freight forwarding; Freighting; garage rental; guarded transport of valuables; providing information relating to storage services; marine transport; motor coach rental; rental of motor racing cars; rental of navigational systems; packaging of goods; parcel delivery; parking place rental; passenger transport; pleasure boat transport; Porterage; railway coach rental; railway transport; railway truck rental; refloating of ships; removal services; rescue operations [transport]; river transport; rental of storage containers; storage / warehousing; storage of goods; taxi transport; tram transport / streetcar transport; Transport; transport and storage of waste / transport and storage of trash; transport brokerage; transport by pipeline; transport of travellers; transport reservation; transport services for sightseeing tours; arranging of transportation for travel tours; providing transportation information; transportation logistics; transporting furniture; travel reservation; unloading cargo; vehicle breakdown towing services; vehicle rental; rental of warehouses; water distribution; water supplying; wrapping of goods; packaging and storage of goods; travel arrangement; air transport; aircraft rental; boat rental; boat storage; boat transport; booking of seats for travel; bus transport; car parking; car rental; car transport; chauffeur services; arranging of cruises; delivery of goods; escorting of travellers; freight [shipping of goods]; garage rental; marine transport; luggage storage; rental of navigational systems; arranging of passenger transportation services for others via an online application; passenger transport; pleasure boat transport; taxi transport; transport reservation; transport of travellers; arranging travel tours; arranging for travel visas and travel documents for persons travelling abroad; travel reservation; vehicle rental; transport services for sightseeing tours; arranging of transportation for travel tours; providing transport information; sightseeing [tourism]; tourist guide services; arranging excursions for tourists; organisation of travel; providing tourist information via the internet; tourist travel reservation services; providing information to tourists relating to excursions and sightseeing; information, advice and consultancy services relating to the aforesaid.), 40(Abrasion; air deodorizing / air deodorizing; air freshening; air purification; rental of air- conditioning apparatus; cloth cutting; cloth dyeing; cloth edging; colour separation services; crease-resistant treatment for clothing; custom assembling of materials for others; decontamination of hazardous materials; destruction of waste and trash; production of energy; rental of generators; incineration of waste and trash; providing information relating to material treatment; planning of materials; processing of cinematographic films; processing of oil; recycling of waste and trash; refining services; sorting of waste and recyclable material [transformation]; rental of space heating apparatus; stripping finishes; up cycling [waste recycling]; vulcanization [material treatment]; waste treatment [transformation]; water treating; welding services;

treatment of materials; soil, waste, organic matter or water treatment services; environmental remediation services; treatment of waste materials and organic matter in the field of environmental pollution control; water conditioning and purification; recycling, waste material and organic matter treatment; recycling services; waste materials and organic matter destruction; waste materials and organic matter management; waste reduction; providing information regarding waste materials and organic matter management, reduction, treatment and recycling; consultancy in relation to waste management, reduction, treatment and recycling; decontamination, depollution and sanitation services for industrial installations and sites, equipment and apparatus; rental of apparatus and installations for generating energy in all forms and providing of information relating thereto; rental of chemical treatment apparatus and installations and provision of information relating thereto; air purification; purification, decontamination and depollution services for air, water and soil; air freshening; timber processing services; timber felling services; treatment of timber; processing of agricultural products; transformation and treatment of all materials for energy production; processing services of natural elements (sun, water, wind) into energy; treatment, recycling and disposal of waste and organic matter; refining; sandblasting; metal treatment; processing and refinement of fuel materials; cloth cutting; custom assembling of materials for others; information, advice and consultancy services relating to the aforesaid.), 41(Abrasion; air deodorizing / air deodorizing; air freshening; air purification; rental of air- conditioning apparatus; cloth cutting; cloth dyeing; cloth edging; colour separation services; crease-resistant treatment for clothing; custom assembling of materials for others; decontamination of hazardous materials; destruction of waste and trash; production of energy; rental of generators; incineration of waste and trash; providing information relating to material treatment; planning of materials; processing of cinematographic films; processing of oil; recycling of waste and trash; refining services; sorting of waste and recyclable material [transformation]; rental of space heating apparatus; stripping finishes; up cycling [waste recycling]; vulcanization [material treatment]; waste treatment [transformation]; water treating; welding services; treatment of materials; soil, waste, organic matter or water treatment services; environmental remediation services; treatment of waste materials and organic matter in the field of environmental pollution control; water conditioning and purification; recycling, waste material and organic matter treatment; recycling services; waste materials and organic matter destruction; waste materials and organic matter management; waste reduction; providing information regarding waste materials and organic matter management, reduction, treatment and recycling; consultancy in relation to waste management, reduction, treatment and recycling; decontamination, depollution and sanitation services for industrial installations and sites, equipment and apparatus; rental of apparatus and installations for generating energy in all forms and providing of information relating thereto; rental of chemical treatment apparatus and installations and provision of information relating thereto; air purification; purification, decontamination and depollution services for air, water and soil; air freshening; timber processing services; timber felling services; treatment of timber; processing of agricultural products; transformation and treatment of all materials for energy production; processing services of natural elements (sun, water, wind) into energy; treatment, recycling and disposal of waste and organic matter; refining; sandblasting; metal treatment; processing and refinement of fuel materials; cloth cutting; custom assembling of materials for others; information, advice and

consultancy services relating to the aforesaid. Education; training; arranging, hosting and conducting seminars, workshops, classes, conferences, and symposiums; academies [education]; amusement park services; providing amusement arcade services; animal training; rental of artwork; rental of audio equipment; arranging of beauty contests; booking of seats for shows; cinema presentations / movie theatre presentations; rental of cinematographic apparatus; club services [entertainment or education]; coaching [training]; arranging and conducting of colloquiums; organization of competitions [education or entertainment]; arranging and conducting of concerts; arranging and conducting of conferences; arranging and conducting of congresses; disc jockey services; electronic desktop publishing; entertainer services; entertainment services; organization of exhibitions for cultural or educational purposes; organization of fashion shows for entertainment purposes; film production, other than advertising films; providing films, not downloadable, via video-on-demand services; conducting fitness classes; providing golf facilities; conducting guided tours; gymnastic instruction; health club services [health and fitness training]; holiday camp services [entertainment]; arranging and conducting of in-person educational forums; rental of indoor aquaria; providing information in the field of education; providing information in the field of entertainment; providing information relating to recreational activities; karaoke services; layout services, other than for advertising purposes; lending library services; rental of lighting apparatus for theatrical sets or television studios; Microfilming; mobile library services / bookmobile services; modelling for artists; rental of motion pictures; movie studio services; providing museum facilities [presentation, exhibitions]; music composition services; production of music; news reporters services; nursery schools; online publication of electronic books and journals; providing online electronic publications, not downloadable; providing online music, not downloadable; providing online videos, not downloadable; party planning [entertainment]; personal trainer services [fitness training]; photographic reporting; Photography; physical education; practical training [demonstration]; presentation of circus performances; presentation of live performances; presentation of variety shows; publication of books; publication of texts, other than publicity texts; production of radio and television programmes; radio entertainment; rental of radio and television sets; recording studio services; providing recreation facilities; arranging and conducting of seminars; rental of show scenery; organization of shows [impresario services]; production of shows; rental of skin diving equipment; Songwriting; rental of sound recordings; sport camp services; organization of sports competitions; providing sports facilities; rental of sports equipment, except vehicles; rental of -ports grounds; rental of stadium facilities; rental of stage scenery;; arranging and conducting of symposiums; teaching / educational services / instruction services; television entertainment; rental of tennis courts; theatre productions; ticket agency services [entertainment]; timing of sports events; toy rental; training services provided via simulators; Translation; Tutoring; rental of video cameras / rental of camcorders; rental of video cassette recorders; videotape editing; rental of videotapes; Videotaping; vocational guidance [education or training advice]; vocational retraining; arranging and conducting of workshops [training]; writing of texts*; zoological garden services; booking of seats for shows; cinema presentations; club services [entertainment or education]; coaching [training]; arranging and conducting of concerts; arranging and conducting of conferences; arranging and conducting of congresses; cultural, educational or entertainment services provided by art galleries; discotheque services; electronic desktop publishing; organisation of exhibitions for cultural or

educational purposes; film production, other than advertising films; game services provided online from a computer network; games equipment rental; conducting fitness classes; providing golf facilities; conducting guided tours; health club services [health and fitness training]; holiday camp services [entertainment]; providing information in the field of entertainment; online publication of electronic books and journals; providing online electronic publications, not downloadable; providing online music, not downloadable; providing online videos, not downloadable; party planning [entertainment]; photography; presentation of live performances; providing recreation facilities; providing user reviews for entertainment or cultural purposes; providing tennis facilities; providing swimming pool facilities; providing leisure facilities; providing entertainment facilities; scuba diving services; water sports services; marine park services; aquarium services; zoos; animal conservation services; museums; theme parks; zoological gardens; educational services relating to environmental conservation; provision of information in relation to all these services; advisory consultancy and information services relating to the aforesaid services), 43(Accommodation bureau services [hotels, boarding houses]; boarding for animals; boarding house bookings; boarding house services; cafe services; cafeteria services; providing campground facilities; canteen services; rental of chairs, tables, table linen, glassware; rental of cooking apparatus; day-nursery [creche] services; rental of drinking water dispensers; food and drink catering; food sculpting; holiday camp services [lodging]; hotel reservations; hotel services; rental of lighting apparatus*; rental of meeting rooms; motel services; reception services for temporary accommodation [management of arrivals and departures]; restaurant services; self-service restaurant services; snack-bar services; rental of temporary accommodation; temporary accommodation reservations; rental of tents; tourist home services; rental of transportable buildings*; services for providing food and drink; temporary accommodation; reservation, booking and information services relating to hotels and temporary accommodation; serviced apartment services [accommodation]; provision of event facilities for conferences, meetings, exhibitions, training sessions, workshops, business fairs, congresses and lectures; hospitality services [accommodation/ food and drink]; restaurants; self-service restaurants; takeaway restaurants; coffee shop services; cafe services; snack-bar services; catering for the provision of food and beverages; accommodation bureau services [hotels, boarding houses]; boarding house bookings; boarding house services; cafeteria services; canteen services; hookah lounge services; rental of meeting rooms; personal chef services; rental of tents; reception services for temporary accommodation [management of arrivals and departures]; rental of transportable buildings; advisory consultancy and information services relating to the aforesaid services.) and 44(Medical services; hospital services; medical clinic services; nursing home services; veterinary services; hygienic and beauty care for human beings or animals; agriculture, aquaculture, horticulture and forestry services; aroma therapy services; beauty salon services; cultivation of plants; dietary and nutritional advice; flower arranging; gardening; hairdressing; health care; health centre services; health spa services; landscape design; landscape gardening; landscape design; massage; medical clinic services; nursing home services; dentist services; optician services; sauna services; solarium services; Turkish bath services; aquaculture services; health and relaxation resort services; health, fitness and medical information services; beauty and skin care services; massage services; cosmetic treatment services; provision of tanning services and facilities; provision of manicure and pedicure services; advisory consultancy;

aroma therapy services; beauty salon services; health spa services; sauna services; health and relaxation resort services; health, fitness and medical information services; dentistry services; hairdressing; health care; health centre services / health centre services; hospital services; pest control services for agriculture, aquaculture, horticulture and forestry; wildlife conservation services; agricultural services relating to environmental conservation; animal breeding; animal farming; animal healthcare services; sustainable agriculture, aquaculture and horticulture services; nursery services; landscape nurseries; forestry management; forest design and maintenance; agricultural services relating to environmental conservation; agriculture, horticulture and forestry services; planting of trees for carbon off setting purposes; cultivation of plants; landscape architecture services; gardening; planting and growing of trees and plants; tree nursery services; tree surgery services; farming equipment rental; advisory consultancy and information services relating to the aforesaid services.) **(526):** None **(730):** HIFD INTELLECTUAL PROPERTY COMPANY (A SINGLE SHAREHOLDER LIMITED COMPANY) of 5th Floor, Tower MU04, AlRaidah Digital City Complex, Al Nakhil District 3807, Riyadh, 12383-6726., Saudi Arabia **(740):** CFL ADVOCATES of P.O. Box 23555 - 00100, Nairobi, Kenya

(210): 126364 **(220):** 06/02/2023

(300): None **(511):** 9(Downloadable software for providing access to and searching for images, audiovisual content, video content, audio content, information, virtual tours and virtual reality content, all in the fields of art, music, culture, history, architecture, entertainment, media, science, and emerging technologies; downloadable software for identifying and providing information about artworks; downloadable software for editing and modifying photos; Downloadable software for providing access to computer games), 41(Providing a website featuring images, audiovisual content, video content, audio content, information, virtual tours and virtual reality content, all in the fields of art, music, culture, history, architecture, entertainment, media; publication for others of online images, audiovisual content, video content, audio content, information, virtual tours and virtual reality content, all in the fields of art, music, culture, history, architecture, entertainment, media, science, and emerging technologies; management and curation for others of content in the fields of art, music, culture, history, architecture, entertainment and media; Entertainment services, namely, providing on-line computer games.) and 42(Providing a website featuring images, audiovisual content, video content, audio content, information, virtual tours and virtual reality content, all in the fields of architecture, science, and emerging technologies; digitization for others of content, and creating digital exhibitions and tours for others, all in the fields of art, music, culture, history, architecture, entertainment, media, science, and emerging technologies; management and curation for others of content in the fields of science and emerging technologies.) **(526):** None **(730):** GOOGLE LLC, a limited liability company and existing under the laws of the State of Delaware of 1600 Amphitheatre Parkway, Mountain View, California 94043, United States of America **(740):** Coulson Harney Advocates of P.O. Box 10643 - 00100, Nairobi, Kenya



(210): 126365 **(220):** 06/02/2023

(300): None **(511):** 9(Downloadable software for providing access to and searching for images, audiovisual content, video content, audio content, information, virtual tours and virtual reality content, all in the fields of art, music, culture, history, architecture, entertainment, media, science, and emerging technologies; downloadable software for identifying and providing information about artworks; downloadable software for editing and modifying photos; Downloadable software for providing access to computer games.), 41(Providing a website featuring images, audiovisual content, video content, audio content, information, virtual tours and virtual reality content, all in the fields of art, music, culture, history, architecture, entertainment, media; publication for others of online images, audiovisual content, video content, audio content, information, virtual tours and virtual reality content, all in the fields of art, music, culture, history, architecture, entertainment, media, science, and emerging technologies; management and curation for others of content in the fields of art, music, culture, history, architecture, entertainment and media; Entertainment services, namely, providing on-line computer games.) and 42(Providing a website featuring images, audiovisual content, video content, audio content, information, virtual tours and virtual reality content, all in the fields of architecture, science, and emerging technologies; digitization for others of content, and creating digital exhibitions and tours for others, all in the fields of art, music, culture, history, architecture, entertainment, media, science, and emerging technologies; management and curation for others of content in the fields of science and emerging technologies) **(526):** The colours green, red, yellow and blue are features of the mark **(730):** GOOGLE LLC, a limited liability company organised and existing under the laws of the State Delaware of 1600 Amphitheatre Parkway, Mountain View, California 94043, United States of America **(740):** Coulson Harvey Advocates of P.O. Box 10643 - 00100, Nairobi, Kenya



(210): 126366 **(220):** 06/02/2023

(300): None **(511):** 9(Software in the nature of a mobile application for accessing, creating, and tracking workouts and customized workouts; software in the nature of a mobile application for designing, providing, tracking, accessing, and managing athletic and fitness workouts, training and coaching plans, and nutrition plans; wearable activity trackers; pulse meters for sporting purposes; digital media, namely, downloadable audio and audiovisual recordings, all in the field of exercise, fitness, wellness and personal development; downloadable software in the nature of an application for use by individuals participating in exercise classes, physical training, and exercise instruction; downloadable software monitoring, measuring, and processing personal activity, fitness plans, training goals, and related feedback and coaching; software in the nature of a mobile application for nutrition planning and tracking; software in the nature of a mobile application providing video clips containing exercise demonstrations and information about workouts), 10(Pulse meters; heart rate monitors; body composition monitors; support bandages; compression bandages; orthopedic bandages; braces for limbs and joints; athletic tape; electric massage apparatus), 28(Physical fitness equipment; physical fitness equipment, namely, exercise bands, exercise straps, and training bars; body-training apparatus; dumbbells; free weights; weights; cases specially adapted for sports equipment; weight lifting equipment, namely, bars and benches; yoga mats; yoga blankets; yoga blocks; yoga towels) and 38(Streaming of audio and video materials on the Internet featuring physical fitness classes, training,

JIMM

instruction, and coaching) **(526)**: None **(730)**: RUIN THE GAME EVENTS, LLC of c/o McDermott Will & Emery LLP, 18565 Jamboree Rd., Suite 250, Irvine, California 92612, United States of America **(740)**: Coulson Harney LLP of P.O. Box 10643 - 00100, Nairobi, Kenya **(210)**: 126375 **(220)**: 08/02/2023 **(300)**: None **(511)**: 30(Tomato Sauce; Tomato ketchup; Tomato-based sauces, spicy sauces based on chopped tomatoes.) **(526)**: Kiri is a coined word with no meaning in English **(730)**: CARAWAY ENTERPRISE of P.O. Box 9405 - 00100, Nairobi, Kenya **(740)**: None



PROVENIR

(210): 126376 **(220)**: 08/02/2023 **(300)**: None **(511)**: 42(Software as a service using artificial intelligence, data integration tools, and machine learning for risk management and analytics in the fields of buy now pay later programs, financial technology, loan origination, small and medium enterprise lending, retail point of sale, digital merchant onboarding, automobile financing, banking, and loan origination; Software as a service for integrating data into decision workflows in the fields of credit, fraud data, open banking, and alternative data; Software development services for others.) **(526)**: None **(730)**: PROVENIR GROUP HOLDINGS, LLC of 1 Upper Pond Road, Bldg F-4th Floor, Parsippany, New Jersey 07054, United States of America **(740)**: CFL Advocates of P.O. Box 23555 - 00100, Nairobi, Kenya

(210): 126377 **(220)**: 08/02/2023 **(300)**: None **(511)**: 12(Shock absorbers for automobile, shock absorbers for suspension for vehicles, shock absorbers spring for for vehicles, suspension shock absorbers for vehicles.) **(526)**: GRegistration of this mark shall give no right to the exclusive use of the letter "G" separately and apart from the mark as a whole. **(730)**: UNILIGHTS LIMITED of P.O. Box 32756 - 00600, Nairobi, Kenya **(740)**: None



BOMBA

(210): 126378 **(220)**: 08/02/2023 **(300)**: None **(511)**: 16(Paper, cardboard and goods made from these materials, not included in other classes; printed matter; bookbinding material; photographs; stationery; adhesives for stationery or household purposes; artists' materials; paint brushes; pen; pencil; eraser; Sharpener; Books; typewriters and office requisites (except furniture); instructional and teaching material (except apparatus); plastic materials for packaging (not included in other classes); printers' type; printing blocks.) **(526)**: "BOMBA" is a Kiswahili word meaning "Hardwork" in English **(730)**: GELX INDUSTRIES LIMITED of P.O. Box 19052 - 00500, Nairobi, Kenya **(740)**: None

(210): 126385 **(220)**: 09/02/2023 **(300)**: None **(511)**: 36(Real estate affairs.) **(526)**: Registration of this mark shall give no right to the exclusive use of the letters "C", "G" and "M" each separately and apart from the mark as a whole. **(730)**: OPTIVEN LIMITED of P.O. Box 623 - 00600, Nairobi, Kenya **(740)**: None

GMC SOFT

(210): 126386 **(220)**: 09/02/2023 **(300)**: None **(511)**: 36(Real estate affairs.) **(526)**: Registration of this mark shall give no right to the exclusive use of the letters "C", "G" and "M" each separately and apart from the mark as a whole. **(730)**: OPTIVEN LIMITED of P.O. Box 623 - 00600, Nairobi, Kenya **(740)**: None

GMC

(210): 126387 (220): 09/02/2023

(300): None (511): 6(Common metals and their alloys, ores; metal materials for building and construction; transportable buildings of metal; non-electric cables and wires of common metal; small items of metal hardware; metal containers for storage or transport; safes.), 40(Treatment of materials; recycling of waste and trash; air purification and treatment of water; printing services; food and drink preservation.) and 42(Scientific and technological services and research and design relating thereto; industrial analysis, industrial research, and industrial design services; quality control and authentication services; design and development of computer hardware and software.) (526): Registration of this mark shall give no right to the exclusive use of the words "GRASSLAND", "HINGE", "JOINT" and "FENCE" each separately and apart from the mark as a whole. 'SHAMBA' is a swahili word which translates to 'FARM' in English. (730): WIRE PRODUCTS LIMITED of Athi River, off Addis Ababa Road, Industrial Area, P.O. Box 18281 - 00500, Nairobi, Kenya (740): None



(210): 126393 (220): 09/02/2023

(300): None (511): 35(Advertising; business management; business administration; office functions.), 42(Scientific and technological services and research and design relating thereto; industrial analysis and research services; design and development of computer hardware and software; legal services.) and 45(Legal services; security services for the physical protection of tangible property and individuals; personal and social services rendered by others to meet the needs of individuals.) (526): Registration of this mark shall give no right to the exclusive use of the words "Associates", "Advocates" the letters "H", "K" and "M" each separately and apart from the mark as a whole. (730): HENRY KIGATIRA MUTEA of P.O. Box 13583 - 00800, Nairobi, Kenya (740): None



(210): 126397 (220): 09/02/2023

(300): None (511): 6(Common metals and their alloys, ores; metal building materials for building and construction; transportable buildings of metal; materials of metal for railway tracks; non-electric cables and wires of common metal; ironmongery, small items of metal hardware; pipes and tubes of metal; metal containers for storage or transport; safes; ores) (526): Registration of this mark shall give no right to the exclusive use of the word "TILE" separately and apart from the mark as a whole. (730): IMPERIAL MABATI FACTORY LIMITED of P.O. Box 21996 - 00100, Nairobi, Kenya (740): None

IMPERIAL TILE

(210): 126398 (220): 09/02/2023

(300): None (511): 6(Common metals and their alloys, ores; metal building materials for building and construction; transportable buildings of metal; materials of metal for railway tracks; non-electric cables and wires of common metal; ironmongery, small items of metal hardware; pipes and tubes of metal; metal containers for storage or transport; safes; ores) (526): Registration of this mark shall give no right to the exclusive use of the words "CLASSIC", "TILE" each separately and apart from the mark as a whole (730): IMPERIAL MABATI FACTORY LIMITED of P.O. Box 21996 - 00100, Nairobi, Kenya (740): None

**IMPERIAL CLASSIC
TILE**

(210): 126445 (220): 10/02/2023

(300): None (511): 5(Pharmaceuticals, medical and veterinary preparations) (526): None (730): DEWADEN HEALTHCARE LTD of P.O. Box 100893 - 00101, Nairobi, Kenya (740): None

TESTOLYFT

(210): 126448 (220): 10/02/2023

(300): None (511): 41(Entertainment.) (526): Registration of this mark shall give no right to the exclusive use of the word "MAMBO" separately and apart from the mark as a whole. The English translation of the swahili words 'MAMBO IMECHEMUKA' is 'Things are boiling' (730): STEPHEN KARUGA KIMANI of P.O. Box 13138 - 00200, Nairobi, Kenya (740): None



(210): 126449 (220): 10/02/2023

(300): None (511): 32(Beers; mineral and aerated waters and other non-alcoholic beverages; fruit beverages and fruit juices; syrups and other preparations for making beverages) (526): Registration of this mark shall give no right to the exclusive use of the words 'Drinking' and 'Water' and the device of 'Water Drop' each separately and apart from the mark as a whole. 'Kevoskah' is a coined word with no English meaning (730): KEVOSKAH ENTERPRISE of P.O. Box 110 - 40600, Siaya, Kenya (740): None



(210): 126450 (220): 10/02/2023

(300): None (511): 5(Pharmaceuticals and veterinary preparations; sanitary preparations for medical purposes; dietetic substances adapted for medical use, food for babies; plasters, materials for dressings; material for stopping teeth, dental wax; sanitizers) (526): None (730): OMILIFE LIMITED, a limited liability company duly incorporated under the laws of Kenya of P.O. Box 104425 - 00101, Nairobi, Kenya (740): None

VALGAN

(210): 126455 (220): 13/02/2023

(300): None (511): 35(Advertising; business management; business administration; office functions.), 38(Telecommunications.) and 41(Education; providing of training; entertainment; sporting and cultural activities.) (526): Registration of this mark shall give no right to the exclusive use of the word "LUOPEAN", "FESTIVAL", the letter "O" and the device of the "drum" each separately and apart from the mark as a whole. (730): RADIO AFRICA LIMITED of P. O. Box 74497 - 00200, Lion Place, Waiyaki Way, Nairobi, Kenya (740): None



(210): 126456 (220): 13/02/2023

(300): None (511): 30(Cakes, Bread, Banana bread, Doughnuts, Croissants, Danishes, Pies, Scones, Samosas, Bread rolls, Buns, Cookies, Muffins, Mandazi, Biscuits, Bread crumbs, Gingerbread, Pancakes, Pizzas, Spring rolls, Waffles, Hotdogs, Corn flakes, Crackers, Macaroni, Pasta, Noodles, Pastry, Popcorn, Puddings, Ravioli, Sandwiches, Tea, Tea-based Beverages, Chocolate, Chocolate-based Beverages, Cocoa, Cocoa-based Beverages, Coffee, Coffee-based Beverages and Confectionery.) (526): Registration of this mark shall give no right to the exclusive use of the words "CAMPUS", "BAKERY" and the devices of "Human Being" and "BREAD" each separately and apart from the mark as a whole. (730): MOUNT KENYA UNIVERSITY of P.O. Box 342 - 01000, Thika, Kenya (740): C.N. Ngugi & Associates Advocates of P.O. Box 1262 - 00606, Nairobi, Kenya



(210): 126458 (220): 13/02/2023

(300): None (511): 30(Sifted maize flour) (526): 'Mkuu' is a swahili word meaning 'Leader, Head or Chief' in English (730): MLIMA GRAINS LTD. of P.O. Box 409 - 50200, Bungoma, Kenya (740): None



(210): 126459 (220): 13/02/2023

(300): None (511): 5(Pest control products (fungicide, herbicides, insecticides) (526): Registration of this mark shall give no right to the exclusive use of the letter "M" separately and apart from the mark as a whole. (730): ENFARM CROP SCIENCE (KENYA) LIMITED of P.O. Box 23007 - 00100, Nairobi, Kenya (740): None



(210): 126460 (220): 13/02/2023

(300): None (511): 5(Pest control products (fungicide, herbicides, insecticides) (526): Registration of this mark shall give no right to the exclusive use of the numeral "2", "4", "0", "7" and the letter "D" each separately and apart from the mark as a whole. (730): ENFARM CROP SCIENCE (KENYA) LIMITED of P.O. Box 23007 - 00100, Nairobi, Kenya (740): None

ENFARM 2,4 D
720

(210): 126461 (220): 13/02/2023

(300): None (511): 5(Pest control products(fungicide, herbicides, insecticides) (526): Registration of this mark shall give no right to the exclusive use of the numeral "2", "4", "0", "8", "6" and the letter "D" each separately and apart from the mark as a whole (730): ENFARM CROP SCIENCE (KENYA) LIMITED of P.O. Box 23007 - 00100, Nairobi, Kenya (740): None

ENFARM 2,4D
860

(210): 126462 (220): 13/02/2023

(300): None (511): 5(Pest control products (fungicide, herbicides, insecticides) (526): None (730): ENFARM CROP SCIENCE (KENYA) LIMITED of P.O. Box 23007 - 00100, Nairobi, Kenya (740): None

ENFARSATE

(210): 126463 (220): 13/02/2023

(300): None (511): 5(Pest control products (fungicide, herbicides, insecticides) (526): None (730): ENFARM CROP SCIENCE (KENYA) LIMITED of P.O. Box 23007 - 00100, Nairobi, Kenya (740): None

TRICON

(210): 126473 (220): 13/02/2023

(300): None (511): 19(Marine boards, three plywood, five layer-plywood, density board, plywood board, gypsum board, wood boards, plaster boards, hardwood and softwood boards, timber board, timber particle boards, plastic and timber building boards, parquet floor boards, wooden floor boards, hardwood and softwood decking boards, non-metallic water proofing boards, nonmetallic wafer boards, non-metallic cladding boards, non-metallic building boards, nonmetallic skirting boards, non-metallic scaffolding boards, non-metallic advertising boards, non-metallic sheathing boards, non-metallic ceiling boards and non-metallic wall boards) (526): Registration of this mark shall give no right to the exclusive use of the words 'WOOD' separately and apart from the mark as a whole. The translation into English of the Chinese word 'DAZHONG' is 'For all persons' (730): SHENGTAI COMPANY LTD of Godown B7 Kongoni Business Park, Athi River, P.O. Box 58560 - 00200, Nairobi, Kenya (740): None



(210): 126474 (220): 13/02/2023

(300): None (511): 3(Make-up, make-up powder, make-up preparations, make-up pencils and make-up remover; nail polish, nail cosmetics, nail make up, nail enamel, nail tips, nail glitter, nail cream, nail polish, nail varnish, nail gel, nail hardener, nail decolourants, nail whitener, nail conditioners, false nails, nail care preparations, gel nail removers, nail polish pens, nail primer, nail sanitizing preparations, nail polish top coat, adhesives for artificial nails, glue for strengthening nails, nail polish base coat, lotions and preparations for strengthening nails, cosmetic preparations for nail drying and powder for forming sculpted finger nail tips; skin cosmetics, skin cosmetic preparations, skin masks, sun barrier; lip cosmetics, lip balm, lip liners, lip gloss, lipstick cases and kits and lip pencils; eye cosmetics, eye liners, eye shadow, eye lashes, eye gels, eye make-up, eye brow pencils and eye brow cosmetics; hair cosmetics, hair shampoos, hair spray, hair lotion, hair tonics, hair colour, hair dyes, hair rinses, hair bleach, hair conditioners, hair creams, hair gels, hair mascara, hair oil and hair mousse; bleach, bleaching preparations, laundry bleach, household bleach, bleaching salts, bleaching soda and dental bleaching gel; beauty products, beauty masks, beauty lotions, beauty gels, beauty serums, beauty



soap and beauty creams; cleansers, facial cleansers, hand cleansers, household cleansers, softening cleansers, cleansing wipes, cleansing tissues; scrubs, body scrub, face scrub, gel scrub, foot scrub and exfoliating scrub; body lotions, polishing, grease removing and abrasive preparations; soaps; perfumery; essential oils, bath oil, body oil, facial oil, massage oil and shaving oil; dentifrices) **(526)**: Registration of this mark shall give no right to the exclusive use of the word 'EXQUISITE' and device of a 'Human Being' each separately and apart from the mark as a whole. **(730)**: ORIENTAL EXQUISITE LIMITED of P.O. Box 6766 - 00100, Nairobi, Kenya **(740)**: None

(210): 126475 **(220)**: 13/02/2023

(300): None **(511)**: 30(Rice) **(526)**: Registration of this mark shall give no right to the exclusive use of the words "Brand", "Biryani", "Rice" and the devices of the "pot" with "ASSORTED FOOD" each separately and apart from the mark as a whole. **(730)**: SALAM IMPEX LIMITED of P. O. Box 408309 - 80100, Mombasa, Kenya **(740)**: None



(210): 126478 **(220)**: 14/02/2023

(300): None **(511)**: 43(Services for providing food and drink) **(526)**: Registration of this mark shall give no right to the exclusive use of the word "Brasserie" separately and apart from the mark as a whole. **(730)**: TAMARIND MANAGEMENT LIMITED, a limited liability company incorporated and registered under the laws of Kenya of P.O. Box 74493 - 00200, Nairobi, Kenya **(740)**: Raffman Dhanji Elms & Virdee Advocates LLP of P.O. Box 10719 - 00100, Nairobi, Kenya

Tamarind BRASSERIE

(210): 126479 **(220)**: 14/02/2023

(300): None **(511)**: 43(Services for providing food and drink) **(526)**: Registration of this mark shall give no right to the exclusive use of the word "BRASSERIE", the acronym "EST" and the year "1972" each separately and apart from the mark as a whole. **(730)**: TAMARIND MANAGEMENT LIMITED, a limited liability company incorporated and registered under the laws of Kenya, of P.O. Box 74493 - 00200, Nairobi, Kenya **(740)**: Raffman Dhanji Elms & Virdee LLP of P.O. Box 10719 - 00100, Nairobi, Kenya



(210): 126481 **(220)**: 14/02/2023

(300): None **(511)**: 5(Pharmaceutical preparation) **(526)**: Registration of this mark shall give no right to the exclusive use of the word "CARE" separately and apart from the mark as a whole. **(730)**: CAREPLUS LIMITED of Godown B10, Kenafric Business Park, Baba Dogo Road, P.O. Box 13742 - 00800, Nairobi, Kenya **(740)**: None

CARESTREP

(210): 126482 **(220)**: 14/02/2023

(300): None **(511)**: 5(Pharmaceutical preparation) **(526)**: None **(730)**: CAREPLUS LIMITED of Godown B10, Kenafric Business Park, Baba Dogo Road, P.O. Box 13742 - 00800, Nairobi, Kenya **(740)**: None

CARENORFCIN

(210): 126483 **(220)**: 14/02/2023

(300): None **(511)**: 5(Pharmaceutical preparation) **(526)**: Registration of this mark shall give no right to the exclusive use of the word "CARE" separately and apart from the mark as a whole. **(730)**: CAREPLUS LIMITED of Godown B10, Kenafric Business Park, Baba Dogo Road, P.O. Box 13742 - 00800, Nairobi, Kenya **(740)**: None

CAREFUSEM

(210): 126484 **(220)**: 14/02/2023

(300): None **(511)**: 5(Pharmaceutical preparation) **(526)**: None **(730)**: CAREPLUS LIMITED of Godown B10, Kenafric Business Park, Baba Dogo Road, P.O. Box 13742 - 00800, Nairobi, Kenya **(740)**: None

AMINOFIN

(210): 126485 (220): 14/02/2023
(300): None (511): 5(Pharmaceutical preparation) (526): None
(730): CAREPLUS LIMITED of Godown B10, Kenafric Business Park, Baba Dogo Road, P.O. Box 13742 - 00800, Nairobi, Kenya (740): None

Metamida

(210): 126486 (220): 14/02/2023
(300): None (511): 5(Pharmaceutical preparation) (526): Registration of this mark shall give no right to the exclusive use of the word "CARE" separately and apart from the mark as a whole.
(730): CAREPLUS LIMITED of Godown B10, Kenafric Business Park, Baba Dogo Road, P.O. Box 13742 - 00800, Nairobi, Kenya (740): None

ENACARE

(210): 126487 (220): 14/02/2023
(300): None (511): 5(Pharmaceutical preparation) (526): Registration of this mark shall give no right to the exclusive use of the word "CARE" separately and apart from the mark as a whole.
(730): CAREPLUS LIMITED of Godown B10, Kenafric Business Park, Baba Dogo Road, P.O. Box 13742 - 00800, Nairobi, Kenya (740): None

CARENAZOL

(210): 126502 (220): 14/02/2023
(300): None (511): 29(Yogurt dressing.) and 30(Mayo mustard dressing, real garlic sauce, tomato Ketchup sauce, real mayonnaise sauce, BBQ, creamy French dressing.) (526): Registration of this mark shall give no right to the exclusive use of the words "SAUCE", "NATURE" and "BEST" each separately and apart from the mark as a whole. (730): REZALI FOOD PRODUCTS LTD of P.O. Box 17680 - 00500, Kenya (740): None



(210): 126505 (220): 14/02/2023
(300): None (511): 41(Education; providing of training; entertainment; sporting and cultural activities.) (526): Registration of this mark shall give no right to the exclusive use of the letter "B", "O" each separately and apart from the mark as a whole. (730): THE BLUE NOTE LIMITED of Bandari Plaza Woodvale Groove Westlands, P.O. Box 13455 - 00800, Nairobi, Kenya (740): None



(210): 126515 (220): 14/02/2023
(300): None (511): 35(Advertising; business management; business administrations, office functions.) (526): "SARUKI" is a coined word with no meaning in English (730): SARUKI COMPANY LIMITED of P.O. Box 51498 - 00200, Nairobi, Kenya (740): None



(210): 126516 (220): 14/02/2023
(300): None (511): 19(Materials, not of metal, for building and constructions; rigid pipes, not of metal, for building, asphalt, pitch, tar and bitumen; transportable buildings, not of metal; monuments, not of metal.) (526): Registration of this mark shall give no right to the exclusive use of the words "CONCRETE" and "PRODUCTS" each separately and apart from the mark as a whole. (730): NOVUMA COMPANY LIMITED of P.O. Box 51498 - 00200, Nairobi, Kenya (740): None



(210): 126525 (220): 15/02/2023
(300): None (511): 35(Advertising; business management; business administration; office functions), 38(Telecommunications) and 41(Education; providing of training; entertainment; sporting and cultural activities.) (526): Registration of this mark shall give no right to the exclusive use of the device of "Music notation" per se separately and apart from the mark as a whole. (730): RADIO AFRICA LIMITED of P.O. Box 74497 - 00200, Lion Place, Waiyaki Way, Nairobi, Kenya (740): None



(210): 126540 (220): 15/02/2023

(300): None (511): 5(Dietary supplement preparations.) (526): Registration of this mark shall give no right to the exclusive use of the device of "HUMAN BEING" per se separately and apart from the mark as a whole. The word "LAITMOM" means "Chocolate granules" (730): ARILIFE SCIENCES LIMITED of Fairlane Plaza, Buruburu, P.O. Box 86 - 00606, Nairobi, Kenya (740): None



(210): 126542 (220): 15/02/2023

(300): None (511): 30(Maize flour.) (526): "TUMAINI" is a Kiswahili word which means "Hope" in English (730): JESANI KAMIESHI KHIMEI of P.O. Box 1199 - 10300, Shree Hari Plaza, Nairobi, Kenya (740): None

TUMAINI

(210): 126543 (220): 15/02/2023

(300): None (511): 30(Maize flour) (526): "BHOOMI" is a Hindu word which means "Land" in English. (730): JESANI KAMIESHI KHIMEI of P.O. Box 1199 - 10300, Shree Hari Plaza, Nairobi, Kenya (740): None

BHOOMI

(210): 126544 (220): 15/02/2023

(300): None (511): 9(Scientific, research, navigation, surveying, photographic, cinematographic, audio-visual, optical, weighing, measuring, signaling, detecting, testing, inspecting, life-saving and teaching apparatus and instruments; Apparatus for recording, transmission, processing, and reproduction of sound, images, or data; digital media, namely, pre-recorded downloadable audio and video recordings, CDs, DVDs, high definition digital discs, mp3 files and mp4 files; Audio discs; audio books; audio recordings; audio and video recordings; audio speakers; binoculars; calculators; camcorders; cameras; cellular telephone accessories; cellular telephone cases; cellular telephone covers; face plates for cellular telephones; cell phone battery chargers; chips containing musical recordings; compact disc players; compact disc recorders; compact discs; computer game programs; computers; computer hardware; computer keyboards; computer monitors; computer mouse; computer disc drives; computer software; decorative magnets; digital cameras; digital video and audio players; DVDs; DVD players; DVD recorders; digital versatile discs; digital video discs; downloadable software applications for mobile devices; downloadable electronic publications; electronic personal organizers; eyeglass cases; eyeglasses; flotation vests; graduated rulers for office and stationery; headphones; karaoke machines; microphones; MP3 players; mouse pads; motion picture films; musical recordings; personal digital assistants; printers; protective helmets for sports; bicycle helmets; radios; snorkels; swimming goggles; swim masks; sunglasses; telephones; television sets; video cameras; downloadable video game software; recorded video game software; video recordings; walkie-talkies; wrist and arm rests for use with computers; protective covers and cases for tablet computers; apparatus and instruments for conducting. switching. transforming. accumulating. regulating or controlling the distribution or use of electricity; apparatus and instruments for recording. transmitting. reproducing or processing sound. images or data; recorded and downloadable media. computer software. blank digital or analogue recording and storage media; mechanisms for coin-operated apparatus; cash registers. calculating devices; computers and computer peripheral devices; diving suits. divers' masks. ear plugs for divers. nose clips for divers and swimmers. gloves for divers. breathing apparatus for underwater swimming; fire-extinguishing apparatus.), 14(Precious metals and their alloys; jewellery. precious and semi-precious stones; horological and chronometric instruments; alarm clocks; bolo ties with precious metal tips; bracelets; busts of precious metal; charms; clocks; earrings; jewelry; jewelry cases of precious metal; jewelry boxes not of precious metal; jewelry chains; decorative key fobs; key chains;

AVATAR

key rings; lapel pins; neck chains; necklaces; necktie fasteners; non-monetary coins; ornamental lapel pins; pendants; rings; slides for bolo ties; stop watches; tie clips; tie fasteners; tie tacks; wall clocks; watch bands; watch cases; watch chains; watch straps; watches; wedding bands; wristwatches.), 16(Paper and cardboard; printed matter; bookbinding material; photographs; stationery and office requisites. except furniture; adhesives for stationery or household purposes; drawing materials and materials for artists; paintbrushes; instructional and teaching materials; plastic sheets. films and bags for wrapping and packaging; printers' type. printing blocks; address books; almanacs; appointment books; art prints; arts and craft paint kits; autograph books; baby books; ball point pens; baseball cards; binders; bookends; bookmarks; books; bumper stickers; calendars; cartoon strips; Christmas cards; chalk; chalk boards; children's activity books; coasters made of paper; coin albums; coloring books; coloring pages; color pencils; comic books; comic strips; coupon books; crayons; decals; decorative paper centerpieces; diaries; drawing rulers; dry erase writing boards; envelopes; erasers; magazines; maps; markers; memo pads; modeling clay; newsletters; newspapers; note paper; notebooks; notebook paper; paintings; paper flags; paper cake decorations; paper party decorations; paper napkins; paper party bags; paperweights; paper gift wrap bows; gift wrapping paper; paper pennants; paper place mats; paper table cloths; plastic party bags; pen or pencil holders; pencils; pencil sharpeners; pen and pencil cases and boxes; pens; periodicals; photograph albums; photographs; pictorial prints; picture books; plastic materials for packaging (not included in other classes); portraits; postcards; posters; printed awards; printed certificates; printed invitations; printed menus; publications; recipe books; rubber stamps; sandwich bags; score cards; stamp albums; stationery; staplers; stickers; trading cards; ungraduated rulers; writing paper; writing implements; letter openers of precious metal; temporary tattoo transfers), 21(Household or kitchen utensils and containers; cookware and tableware, except forks, knives and spoons; combs and sponges; brushes, except paintbrushes; brush making materials; articles for cleaning purposes; unworked or semi-worked glass, except building glass; glassware, porcelain and earthenware; bakeware; beverageware; beverage glassware; bowls; brooms; busts of ceramic, crystal, china, terra cotta, earthenware, porcelain or glass; cake pans; cake molds; candle holders; candle snuffers; candlesticks; canteens; coasters, not of paper or textile; hair combs; cookie jars; cookie cutters; cork screws; cups; decorating bags for confectioners; decorative crystal prisms; decorative glass not for building; decorative plates; dinnerware; dishware; dishes; drinking straws; figurines made of ceramic, china, crystal, earthenware, glass, or porcelain; hair brushes; heat-insulated vessels; household containers for food and beverages; insulating sleeve holders for beverage containers; non-electric kettles; lunch boxes; lunch kits comprising lunch boxes and insulated beverage containers for domestic use; mugs; napkin holders; napkin rings not of precious metals; non-metallic trays for domestic purposes; serving trays; pie pans; pie servers; plates; non-electric portable coolers; servingware for serving food; sports bottles sold empty; soap dishes; tea pots; tea sets; toothbrushes; trivets; vacuum bottles; waste baskets; barbecue mitts; oven mitts; pot holders; thermal insulated containers and bags for food or beverages.), 25(Clothing, footwear and headgear including aprons; athletic shoes; bandanas; baseball caps; beach cover-ups; beachwear; belts; bibs; bikinis; blazers; boots; bow ties; bras; caps; chaps; cloth bibs; coats; dresses; ear muffs; footwear; gloves; golf shirts; Halloween costumes; hats; head bands; headwear; hosiery; infantwear; jackets; jeans; jerseys;

kerchiefs; leotards; leg warmers; mittens; neckties; night shirts; night gowns; overalls; pajamas; pants; panty hose; polo shirts; ponchos; rainwear; robes; sandals; scarves; shirts; shoes; skirts; shorts; slacks; slippers; sleepwear; socks; stockings; sweaters; sweat pants; sweat shirts; swimsuits; tank tops; tights; T-shirts; underwear; vests; wrist bands.), 28(Games, toys and playthings; video game apparatus; gymnastic and sporting articles; decorations for Christmas trees; action skill games; action figures; board games; card games; children's multiple activity toys; badminton sets; balloons; basketballs; bath toys; baseball bats; baseballs; beach balls; bean bags; bean bag dolls; bobble head dolls; bowling balls; bubble making wand and solution sets; chess sets; toy imitation cosmetics; Christmas stockings; Christmas tree ornaments and decorations; collectable toy figures; crib mobiles; crib toys; disc toss toys; dolls; doll clothing; doll accessories; doll playsets; electric action toys; equipment sold as a unit for playing card games; fishing tackle; fishing rods; footballs; golf balls; golf gloves; golf ball markers; hand-held units for playing electronic games for use with or without an external display screen or monitor; hockey pucks; hockey sticks; infant toys; inflatable toys; inflatable pool toys; jigsaw puzzles; jump ropes; kites; magic tricks; marbles; manipulative games; mechanical toys; music box toys; musical toys; parlor games; party favors in the nature of small toys; paper party favors; paper party hats; party games; playing cards; plush toys; puppets; roller skates; role playing toys in the nature of play sets for children to imitate real life occupations; rubber balls; skateboards; snow boards; snow globes; soccer balls; spinning tops; squeeze toys; stuffed toys; table tennis balls; table tennis paddles and rackets; table tennis tables; talking toys; target gam-s; teddy bears; tennis balls; tennis rackets; toy action figures and accessories therefor; toy boats; toy bucket and shovel sets in the nature of sand toys; toy building blocks; toy mobiles; toy vehicles; toy scooters; toy cars; toy figures; toy banks; toy vehicles in the nature of trucks; toy watches; toy weapons; toy building structures and toy vehicle tracks; video game machines for use with televisions; volley balls; wind-up toys; yo-yos; toy trains and parts and accessories therefor; toy aircraft; fitted plastic films known as skins for covering and protecting electronic game playing apparatus, namely, video game consoles, and hand-held video game units.) and 41(Educational services; services relating to the provision of training; entertainment services; sporting and cultural activities; development, creation, production, and distribution of digital multimedia and audio and visual content, namely, motion picture films, television programs, radio programs, and multimedia entertainment and educational content; development, creation, production, distribution, and rental of audio and visual recordings; production of entertainment shows and interactive programs for distribution via audio and visual media, and electronic means; production and provision of entertainment news and entertainment information via electronic communication networks; providing online computer games, websites and applications featuring a wide variety of general interest entertainment information relating to motion picture films, television programs, musical videos, film clips, photographs, and other multimedia materials; entertainment services, namely, providing online and subscription games; online games; amusement park and theme park services; educational and entertainment services rendered in or relating to theme parks, namely, live stage shows, live amusement park shows, live performances by performances; production and presentation of live shows; theater

productions; entertainer services, namely, live appearances by a professional entertainer.) **(526)**: None **(730)**: TWENTIETH CENTURY FOX FILM CORPORATION, a corporation existing under the laws of the State of Delaware of 10201 West Pico Boulevard, Los Angeles, California 90035, United States of America **(740)**: Coulson Harney Advocates of P. O. Box 10643 - 00100, Nairobi, Kenya

(210): 126548 **(220)**: 15/02/2023

CREZ

(300): None **(511)**: 3(Soaps, perfumery, essential oils, cosmetics, hair lotions, bath and shower gels (not for medical use), body lotions and body milks (for cosmetic use), hand creams, shampoos and conditioners: petroleum jelly for cosmetic purposes) **(526)**: None **(730)**: COMAFRICA MARKETING CC of Cnr Barolong & Thembu Street, Icon Industrial Park, Sunderland Ridge, Centurion, Gauteng, South Africa **(740)**: Coulson Harney Advocates of P.O. Box 10643 - 00100, Nairobi, Kenya

(210): 126550 **(220)**: 15/02/2023

**SUNRISE
HOMESCHOOLING**

(300): None **(511)**: 41(Distance learning services provided online) **(526)**: Registration of this mark shall give no right to the exclusive use of the word "HOMESCHOOLING" separately and apart from the mark as a whole. **(730)**: BERNARD KAIRU of P.O. Box 2145 - 00200, Nairobi, Kenya **(740)**: None

(210): 126561 **(220)**: 17/02/2023

 PAWAFIL

(300): None **(511)**: 5(Pharmaceutical preparations.) **(526)**: None **(730)**: ARILIFE SCIENCES of P.O. Box 18 - 00606, Nairobi, Kenya **(740)**: None

(210): 126564 **(220)**: 17/02/2023

SWIFTEE NOODLES

(300): None **(511)**: 30(Flour and preparations made from cereals.) **(526)**: Registration of this mark shall give no right to the exclusive use of the word "NOODLES" separately and apart from the mark as a whole. **(730)**: KAPA OILREFINERIES LIMITED of P.O. Box 18492 - 00500, Nairobi, Kenya **(740)**: Mumbi & Co. Advocates of P.O. Box 21507 - 00100, Nairobi, Kenya

(210): 126565 **(220)**: 17/02/2023

INST@NOODLES

(300): None **(511)**: 30(Flour and preparations made from cereals.) **(526)**: Registration of this mark shall give no right to the exclusive use of the word "NOODLES" and the symbol "@" each separately and apart from the mark as a whole. **(730)**: KAPA OILREFINERIES LIMITED of P.O. Box 18492 - 00500, Nairobi, Kenya **(740)**: Mumbi & Co. Advocates of P.O. Box 21507 - 00100, Nairobi, Kenya

(210): 126566 **(220)**: 17/02/2023

RAHA NOODLES

(300): None **(511)**: 30(Flour and preparations made from cereals.) **(526)**: Registration of this mark shall give no right to the exclusive use of the words "RAHA" and "NOODLES" each separately and apart from the mark as a whole. "RAHA" is a Kiswahili word translated to mean "Happiness" in English. **(730)**: KAPA OILREFINERIES LIMITED of P.O. Box 18492 - 00500, Nairobi, Kenya **(740)**: Mumbi & Co. Advocates of P.O. Box 21507 - 00100, Nairobi, Kenya

(210): 126567 **(220)**: 17/02/2023

NALA NOODLES

(300): None **(511)**: 30(Flour and preparations made from cereals.) **(526)**: Registration of this mark shall give no right to the exclusive use of the word "NOODLES" separately and apart from the mark as a whole. "NALA" is a swahili word translated to mean "Queen", "Lion" and "Successful" in English **(730)**: KAPA OILREFINERIES LIMITED of P.O. Box 18492 - 00500, Nairobi, Kenya **(740)**: Mumbi & Co. Advocates of P.O. Box 21507 - 00100, Nairobi, Kenya

(210): 126568 **(220):** 17/02/2023**(300):** None **(511):** 30(Flour and preparations made from cereals.)**(526):** Registration of this mark shall give no right to the exclusive use of the word "NOODLES" separately and apart from the mark as a whole. "ZAZI" is a swahili word translated to mean "Fruitful" and "Fertile" in English. **(730):** KAPA OILREFINERIES LIMITED of P.O. Box 18492 - 00500, Nairobi, Kenya **(740):** Mumbi & Co. Advocates of P.O. Box 21507 - 00100, Nairobi, Kenya**ZAZI NOODLES****(210):** 126569 **(220):** 17/02/2023**(300):** None **(511):** 30(Flour and preparations made from cereals.)**(526):** Registration of this mark shall give no right to the exclusive use of the word "NOODLES" separately and apart from the mark as a whole. "LULU" is a Kiswahili word translated to mean "Precious", "Peaceful", "Protected" and "Calm" in English. **(730):** KAPA OILREFINERIES LIMITED of P.O. Box 18492 - 00500, Nairobi, Kenya **(740):** Mumbi & Co. Advocates of P.O. Box 21507 - 00100, Nairobi, Kenya**LULU NOODLES****(210):** 126570 **(220):** 17/02/2023**(300):** None **(511):** 45(Christian ministry services) **(526):**1Registration of this mark shall give no right to the exclusive use of the numerals "1", "3" and "8" each separately and apart from the mark as a whole. **(730):** INN KEEPERS MINISTRY of P.O. Box 76185 - 00508, Nairobi, Kenya **(740):** None**BASE 318****(210):** 126592 **(220):** 20/02/2023**(300):** None **(511):** 44(Agriculture, Forestry, Horticulture, Medical and Veterinary services, Hygiene and Beauty care for animals and humans) **(526):** Registration of this mark shall give no right to the exclusive use of the words "KILIMO", "GURU", "VALUE", "OPPORTUNITY" and the device of "leaves" each separately and apart from the mark as a whole. **(730):** EVANS MURIKI of P.O. Box 535 - 00516, Nairobi, Kenya **(740):** None**(210):** 126600 **(220):** 20/02/2023**(300):** None **(511):** 9(Mobile power supply (rechargeable power supply); Battery; Solar cells; photovoltaic cells; Storage battery; Battery charger; Solar panes for power generation; ignition battery; batteries for electronic cigarettes) **(526):** Registration of this mark shall give no right the exclusive use of the word "SHEMERS" separately and apart from the mark as a whole. **(730):** SHENZHEN QINZHOU TECHNOLOGY CO., LTD. of P.O. Box 18945 - 00100, Nairobi, Kenya **(740):** None**SHEMERS****(210):** 126625 **(220):** 22/02/2023**(300):** None **(511):** 30(Wheat flour) **(526):** Registration of this mark shall give no right to the exclusive use of the word "MILLERS" and device of "wheat" each separately and apart from the mark as a whole. **(730):** ROSEMARY WANJIRA MBIRA of P.O. Box 312 - 10200, Muranga, Kenya **(740):** None**(210):** 126630 **(220):** 22/02/2023**(300):** None **(511):** 25(Clothing) **(526):** Registration of this mark shall give no right the exclusive use of the words "WHATS", "NEW", "CREATES", "YOU", "SNOODIE", "WEAR" each separately and apart from the mark as a whole. "WINCY" is a coined word **(730):** WINSTON MUKHULA WERE of P.O. Box 62343 - 00200, Nairobi, Kenya **(740):** None**(210):** 126635 **(220):** 23/02/2023**(300):** None **(511):** 1(Liquid fertilizer) **(526):** None **(730):** VETPRO LTD, a limited liability company incorporated in Kenya of P.O. Box 541 - 10100, Nyeri, Kenya **(740):** None**BOSSFOLIA**

(210): 126636 (220): 23/02/2023
 (300): None (511): 31(Animal Foodstuff/supplements) (526): None
 (730): KEMICAS GENERAL ENTERPRISES of P.O. Box 19060 - 00100,
 Nairobi, Kenya (740): None

KEMILICK

(210): 126637 (220): 23/02/2023
 (300): None (511): 24(Textiles) (526): Registration of this mark shall
 give no right the exclusive use of the words "KHANGA NZITO",
 "100%", "SYMBOL OF THE QUALITY", and the device of "Flowers" each
 separately and apart from the mark as a whole. The translation of
 the swahili words "NZITO", "MALI", "BAHATI" are "Heavy", "Property"
 and "Fortune" respectively in English. (730): YASSIR BHARADIA of
 P.O. Box 1870 - 80100, Mombasa, Kenya (740): None



(210): 126642 (220): 23/02/2023
 (300): None (511): 36(Insurance; financial affairs; monetary affairs;
 charitable fundraising; real estate affairs services) and 42(Scientific
 and technological services and research and design relating thereto;
 industrial analysis and research services; design and development of
 computer hardware and software services) (526): Registration of this
 mark shall give no right to the exclusive use of the word "ALL" and
 the numeral "4" each separately and a part from the mark as a
 whole. The word "MIMINISISI" is coined from Kiswahili words "Mimi"
 and "Sisi" which means "Me" and "Ourselves" (730): CROSS GATE
 SOLUTIONS LIMITED of P.O. Box 175, Sarit Centre, Westlands Street,
 Nairobi, Kenya (740): Fred Otswong'o & IP Associates of P.O. Box
 54708 - 00200, Nairobi, Kenya



(210): 126647 (220): 23/02/2023
 (300): None (511): 3(Preparations for application to or care of the
 skin, scalp, hair or nails; soaps; perfumes; essential oils; make-up;
 deodorants; cosmetics; decorative cosmetic transfers; mattifying
 paper; non-medicated toilet preparations.) (526): None (730):
 CHANEL LIMITED of 5 Queensway, Croydon, CR9 4DL, England (740):
 Coulson Harney Advocates of P.O. Box 10643 - 00100, Nairobi, Kenya

SUPERLEGGERA

(210): 126652 (220): 24/02/2023
 (300): None (511): 9(Electronics, phones and phone accessories)
 (526): CRegistration of this mark shall give no right to the exclusive
 use of the letter "C" separately and apart from the mark as a whole.
 (730): SABA ELECTRONICS CO. LTD. of P.O. Box 490 - 00610, Nairobi,
 Kenya (740): None

C-TEL

(210): 126653 (220): 24/02/2023
 (300): None (511): 30(Bread) (526): Registration of this mark shall
 give no right to the exclusive use of the word "BREAD" separately and
 apart from the mark as a whole. (730): DOLLAR BAKERS of P.O. Box
 458 - 00200, Nairobi, Kenya (740): None

BOSSY BREAD

(210): 126654 (220): 24/02/2023
 (300): None (511): 5(Fungicide.) (526): Registration of this mark
 shall give no right to the exclusive use of the letter "C", "S" and the
 numerals "5", "6", "7" and "8" each separately and apart from the
 mark as a whole. (730): UNITED CROP SCIENCE CO. LTD of P.O. Box
 37351 - 00100, Nairobi, Kenya (740): None

FLUOPRO 687.5 SC

(210): 126655 (220): 24/02/2023
 (300): None (511): 5(Insecticide) (526): Registration of this mark
 shall give no right to the exclusive use of the letter "S", "C" and the
 numerals "0" and "6" each separately and apart from the mark as a
 whole. (730): UNITED CROP SCIENCE CO. LTD of P.O. Box 37351 -
 00100, Nairobi, Kenya (740): None

CHLOMEC 60 SC

(210): 126656 (220): 24/02/2023
 (300): None (511): 5(Insecticide.) (526): Registration of this mark
 shall give no right to the exclusive use of the letter "E", "C" and the
 numerals "5" and "7" each separately and apart from the mark as a
 whole. (730): UNITED CROP SCIENCE CO. LTD of P.O. Box 37351 -
 00100, Nairobi, Kenya (740): None

LACET 75 EC

HYDRAQUIN**(210):** 126667 **(220):** 24/02/2023**(300):** None **(511):** 5(Pharmaceutical and veterinary preparations; Sanitary preparations for medical purposes, dietic substances adapted for medical use, food for babies; plasters, materials for dressing ; material for stopping teeth, dental wax; disinfectants; sanitizers) **(526):** None **(730):** HAZELLA LTD, a limited liability company duly incorporated under the laws of Kenya of P.O. Box 5547 - 00200, Nairobi, Kenya **(740):** None**MINOL****(210):** 126668 **(220):** 24/02/2023**(300):** None **(511):** 5(Pharmaceutical and veterinary preparations; Sanitary preparations for medical purposes, dietic substances adapted for medical use, food for babies; plasters, materials for dressing ; material for stopping teeth, dental wax; disinfectants; sanitizers) **(526):** None **(730):** HAZELLA LTD, a limited liability company duly incorporated under the laws of Kenya of P.O. Box 5547 - 00200, Nairobi, Kenya **(740):** None**MINOL****(210):** 126668 **(220):** 24/02/2023**(300):** None **(511):** 5(Pharmaceutical and veterinary preparations ; Sanitary preparations for medical purposes, dietic substances adapted for medical use, food for babies; plasters, materials for dressing; material for stopping teeth, dental wax; disinfectants; sanitizers) **(526):** None **(730):** HAZELLA LTD, a limited liability company duly incorporated under the laws of Kenya of P.O. Box 5547 - 00200, Nairobi, Kenya **(740):** None**HAZERIN****(210):** 126669 **(220):** 24/02/2023**(300):** None **(511):** 5(Pharmaceutical and veterinary preparations; Sanitary preparations for medical purposes, dietic substances adapted for medical use, food for babies; plasters, materials for dressing; material for stopping teeth , dental wax; disinfectants; sanitizers) **(526):** None **(730):** HAZELLA LTD, a limited liability company duly incorporated under the laws of Kenya of P.O. Box 5547 - 00200, Nairobi, Kenya **(740):** None**MUPIRO****(210):** 126670 **(220):** 24/02/2023**(300):** None **(511):** 5(Pharmaceutical and veterinary preparations ; Sanitary preparations for medical purposes, dietic substances adapted for medical use, food for babies; plasters, materials for dressing ; material for stopping teeth , dental wax; disinfectants; sanitizers) **(526):** None **(730):** HAZELLA LTD, a limited liability company duly incorporated under the laws of Kenya of P.O. Box 5547 - 00200, Nairobi, Kenya **(740):** None**RETINOIN****(210):** 126671 **(220):** 24/02/2023**(300):** None **(511):** 5(Pharmaceutical and veterinary preparations; Sanitary preparations for medical purposes, dietic substances adapted for medical use, food for babies; plasters, materials for dressing ; material for stopping teeth, dental wax; disinfectants; sanitizers) **(526):** None **(730):** HAZELLA LTD, a limited liability company duly incorporated under the laws of Kenya of P.O. Box 5547 - 00200, Nairobi, Kenya **(740):** None**(210):** 126689 **(220):** 27/02/2023**(300):** None **(511):** 16(Letterhead, business cards, magazines, company profiles, printed matter, office stationery /requisites etc.) and 35(Retail in goods) **(526):** None **(730):** WABARAZA MARKETING LIMITED LIABILITY PARTNERSHIP of P.O. Box 7014 - 00200, Nairobi, Kenya **(740):** Sajni Galaiya & Co. Advocates of P.O. Box 43201 - 00100, Nairobi, Kenya**CYCLOW****(210):** 126721 **(220):** 28/02/2023**(300):** None **(511):** 5(Pharmaceuticals) **(526):** None **(730):** GLOBE PHARMACY LIMITED of P.O. Box 58171 - 00200, Nairobi, Kenya **(740):** None

(210): 126723 (220): 28/02/2023
(300): None (511): 32(Non-alcoholic beverages) and 33(Wines/alcoholic beverages) (526): The translation into English of the Italian phrase 'Donna De Monte' is 'Woman of the mountain' (730): PINNACLE FIELDS LIMITED of P.O. Box 2418 - 00100, Nairobi, Kenya (740): None



(210): 126733 (220): 01/03/2023
(300): None (511): 36(Real Estate Services) (526): None (730): NATARE HOMES LIMITED of P.O. Box 13726 - 00100, Nairobi, Kenya (740): Maina & Onsare Patners Advocates of P.O. Box 35255 - 00100, Nairobi, Kenya



(210): 126736 (220): 02/03/2023
(300): None (511): 24(Textiles) (526): None (730): EMMANUEL MUANGE MUSYOKA of P.O. Box 13758 - 00400, Nairobi, Kenya (740): None



(210): 126738 (220): 02/03/2023
(300): None (511): 4(Methylated spirit) (526): Registration of this mark shall give no right to the exclusive use of the numerals '2','4', and '7' each separately and apart from the mark as a whole. (730): BIKEN SCIENTIFIC LTD of nzapat@yahoo.com (740): None

BIOFIX.247

(210): 126742 (220): 02/03/2023
(300): None (511): 9(Software applications.) (526): ERegistration of this mark shall give no right to the exclusive use of the letter "E" separately and apart from the mark as a whole. (730): LIFETIME CONSULTING LIMITED of P.O. Box 2164 - 00900, Nairobi, Kenya (740): None



(210): 126749 (220): 02/03/2023
(300): None (511): 5(Infant formula, milk for babies, food for babies) (526): Registration of this mark shall give no right to the exclusive use of the word 'Gold pro +' each separately and apart from the mark as a whole. (730): DANAFLIN INTERNATIONAL LIMITED of P. O. Box 7183 - 40100, Nairobi, Kenya (740): Amuga & Company Advocates of P.O. Box 13008 - 00100, Nairobi, Kenya



(210): 126750 (220): 02/03/2023
(300): None (511): 5(Infant formula, milk for babies, food for babies) (526): Registration of this mark shall give no right to the exclusive use of the word 'GOAT' separately and apart from the mark as a whole. (730): DANAFLIN INTERNATIONAL LIMITED of P.O. Box 7183 - 40100, Nairobi, Kenya (740): Amuga & Company Advocates of P.O. Box 13008 - 00100, Nairobi, Kenya



(210): 126777 (220): 03/03/2023
(300): None (511): 41(Casino services) (526): Registration of this mark shall give no right to the exclusive use of the word 'Casino' separately and apart from the mark as a whole. (730): GAME GUYS LIMITED of P.O. Box 34776 - 00100, Nairobi, Kenya (740): None



(210): 126784 (220): 06/03/2023

(300): None (511): 16(Paper, cardboard and goods made from these materials, not included in other classes; printed matter; bookbinding material; photographs; stationery; adhesives for stationery or household purposes; artists' materials; paint brushes; typewriters and office requisites (except furniture); instructional and teaching material (except apparatus); plastic materials for packaging (not included in other classes); printers' type; printing blocks) (526): Registration of this mark shall give no right to the exclusive use of the word 'Care' separately and apart from the mark as a whole. (730): QUESTA CARE LIMITED of P.O. Box 172 - 00623, Nairobi, Kenya (740): None



(210): 126818 (220): 08/03/2023

(300): None (511): 35(Export agency of fruits) (526): Registration of this mark shall give no right the exclusive use of the words "FENESI", "GROWERS", "LIMITED" and the device of "leaves" each separately and apart from the mark as a whole. "FENESI" is a swahili word that means "Jackfruit" (730): FENESI GROWERS LIMITED of P.O. Box 555 - 00623 Nairobi, Kenya (740): None



11.2 Corrigenda

(111) Mark number: 108015

(540) Trade Mark:



(511) Class: 9

(442) Date of advertisement: 28th February, 2023

(580) Corrections

The amended goods should correctly appear as below:

9 (Smartphones; Mobile phones; Cell phone cases; Covers of cell phones; Protective films adapted for mobile phone screens; Stands adapted for mobile phones; Headphones; Headsets for mobile phones; Selfie sticks for use with smartphones; USB cables; Power adapters; Batteries, electric; Battery chargers; Mobile power banks (rechargeable batteries); Loudspeakers; Intelligent loudspeakers; Wireless headsets for smart phones; Wireless chargers; Downloadable application software for mobile phones; Computers; Smart glasses; Smart watches & Tablet computers, Notebook computers, televisions, smart televisions, Wireless earphones & wireless loudspeakers).

11.3 Licence

(111) Mark number: 48431

(540) Mark:



(511) Class: 29

(730) Proprietor: PROMASIDOR IP HOLDING LIMITED of Ebene Junction, Rue de la Démocratie, Ebéne, Mauritius

(791) Licensee: PROMASIDOR (KENYA) LIMITED, a company duly incorporated in Kenya under the Companies Act, Chapter 486 Laws of Kenya of Suvida Complex, Beijing Road, off Mombasa Road, Mlolongo-Athi River, P.O. Box 10336 - 00100, Nairobi, Kenya

(740) Address for correspondence: Chebet & Co. Advocates of P.O. Box 3563 - 00506, Nairobi, Kenya

(111) Mark number: **48478**

(540) Mark:



(511) Class: **30**

(730) Proprietor: **PROMASIDOR IP HOLDING LIMITED** of Ebene Junction, Rue de la Démocratie, Ebéne, Mauritius

(791) Licensee: **PROMASIDOR (KENYA) LIMITED**, a company duly incorporated in Kenya under the Companies Act, Chapter 486 Laws of Kenya of Suvida Complex, Beijing Road, off Mombasa Road, Mlolongo-Athi River, P.O. Box 10336 - 00100, Nairobi, Kenya

(740) Address for correspondence: **Chebets & Co. Advocates** of P.O. Box 3563 - 00506, Nairobi, Kenya

.....
111) Mark number: **51074**

(540) Mark:

MIKSI

(511) Class: **29**

(730) Proprietor: **PROMASIDOR IP HOLDING LIMITED** of Ebene Junction, Rue de la Démocratie, Ebéne, Mauritius

(791) Licensee: **PROMASIDOR (KENYA) LIMITED**, a company duly incorporated in Kenya under the Companies Act, Chapter 486 Laws of Kenya of Suvida Complex, Beijing Road, off Mombasa Road, Mlolongo-Athi River, P.O. Box 10336 - 00100, Nairobi, Kenya

(740) Address for correspondence: **Chebets & Co. Advocates** of P.O. Box 3563 - 00506, Nairobi, Kenya

.....
(111) Mark number: **69949**

(540) Mark:



(511) Class: **29**

(730) Proprietor: **PROMASIDOR IP HOLDING LIMITED** of Ebene Junction, Rue de la Démocratie, Ebéne, Mauritius

(791) Licensee: **PROMASIDOR (KENYA) LIMITED**, a company duly incorporated in Kenya under the Companies Act, Chapter 486 Laws of Kenya of Suvida Complex, Beijing Road, off Mombasa Road, Mlolongo-Athi River, P.O. Box 10336 - 00100, Nairobi, Kenya

(740) Address for correspondence: **Chebets & Co. Advocates** of P.O. Box 3563 - 00506, Nairobi, Kenya

.....
111) Mark number: **78265**

(540) Mark:



(511) Classes: **29 & 32**

(730) Proprietor: **PROMASIDOR IP HOLDING LIMITED** of Ebene Junction, Rue de la Démocratie, Ebéne, Mauritius

(791) Licensee: **PROMASIDOR (KENYA) LIMITED**, a company duly incorporated in Kenya under the Companies Act, Chapter 486 Laws of Kenya of Suvida Complex, Beijing Road, off Mombasa Road, Mlolongo-Athi River, P.O. Box 10336 - 00100, Nairobi, Kenya

(740) Address for correspondence: **Chebets & Co. Advocates** of P.O. Box 3563 - 00506, Nairobi, Kenya

.....
111) Mark number: **82120**

(540) Mark:

TWISCO

(511) Classes: **29 & 32**

(730) Proprietor: **PROMASIDOR IP HOLDING LIMITED** of Ebene Junction, Rue de la Démocratie, Ebéne, Mauritius

(791) Licensee: **PROMASIDOR (KENYA) LIMITED**, a company duly incorporated in Kenya under the Companies Act, Chapter 486 Laws of Kenya of Suvida Complex, Beijing Road, off Mombasa Road, Mlolongo-Athi River, P.O. Box 10336 - 00100, Nairobi, Kenya

(740) Address for correspondence: **Chebets & Co. Advocates** of P.O. Box 3563 - 00506, Nairobi, Kenya

111) Mark number: **85335**

(540) Mark:



(511) Classes: **29, 30 & 32**

(730) Proprietor: **PROMASIDOR IP HOLDING LIMITED** of Ebene Junction, Rue de la Démocratie, Ebéne, Mauritius

(791) Licensee: **PROMASIDOR (KENYA) LIMITED**, a company duly incorporated in Kenya under the Companies Act, Chapter 486 Laws of Kenya of Suvida Complex, Beijing Road, off Mombasa Road, Mlolongo-Athi River, P.O. Box 10336 - 00100, Nairobi, Kenya

(740) Address for correspondence: **Chebets & Co. Advocates** of P.O. Box 3563 - 00506, Nairobi, Kenya

111) Mark number: **85734**

(540) Mark:



(511) Classes: **29, 30 & 32**

(730) Proprietor: **PROMASIDOR IP HOLDING LIMITED** of Ebene Junction, Rue de la Démocratie, Ebéne, Mauritius

(791) Licensee: **PROMASIDOR (KENYA) LIMITED**, a company duly incorporated in Kenya under the Companies Act, Chapter 486 Laws of Kenya of Suvida Complex, Beijing Road, off Mombasa Road, Mlolongo-Athi River, P.O. Box 10336 - 00100, Nairobi, Kenya

(740) Address for correspondence: **Chebets & Co. Advocates** of P.O. Box 3563 - 00506, Nairobi, Kenya

111) Mark number: **90534**

(540) Mark:



(511) Classes: **29 & 30**

(730) Proprietor: **PROMASIDOR IP HOLDING LIMITED**, a limited liability company established under the laws of Mauritius of Ebene Junction, Rue de la Démocratie, Ebéne, Mauritius

(791) Licensee: **PROMASIDOR (KENYA) LIMITED**, a company duly incorporated in Kenya under the Companies Act, Chapter 486 Laws of Kenya of Suvida Complex, Beijing Road, off Mombasa Road, Mlolongo-Athi River, P.O. Box 10336 - 00100, Nairobi, Kenya

(740) Address for correspondence: **Chebets & Co. Advocates** of P.O. Box 3563 - 00506, Nairobi, Kenya

111) Mark number: **95853**

(540) Mark:

ONGA

(511) Classes: **29 & 30**

(730) Proprietor: **PROMASIDOR IP HOLDING LIMITED**, a company established under the laws of Mauritius of Ebene Junction, Rue de la Démocratie, Ebène, Mauritius
 (791) Licensee: **PROMASIDOR (KENYA) LIMITED**, a company duly incorporated in Kenya under the Companies Act, Chapter 486 Laws of Kenya of Suvida Complex, Beijing Road, off Mombasa Road, Mlolongo-Athi River, P.O. Box 10336 - 00100, Nairobi, Kenya
 (740) Address for correspondence: **Chebets & Co. Advocates** of P.O. Box 3563 - 00506, Nairobi, Kenya

111) Mark number: **98081**

(540) Mark:

ONGA

(511) Classes: **29 & 30**

(730) Proprietor: **PROMASIDOR IP HOLDING LIMITED**, a limited liability company established under the laws of Mauritius of Ebene Junction, Rue de la Démocratie, Ebène, Mauritius

(791) Licensee: **PROMASIDOR (KENYA) LIMITED**, a company duly incorporated in Kenya under the Companies Act, Chapter 486 Laws of Kenya of Suvida Complex, Beijing Road, off Mombasa Road, Mlolongo-Athi River, P.O. Box 10336 - 00100, Nairobi, Kenya

(740) Address for correspondence: **Chebets & Co. Advocates** of P.O. Box 3563 - 00506, Nairobi, Kenya

111) Mark number: **106491**

(540) Mark:

SOSSI

(511) Classes: **29, 30 & 31**

(730) Proprietor: **PROMASIDOR IP HOLDING LIMITED** of Ebene Junction, Rue de la Démocratie, Ebène, Mauritius

(791) Licensee: **PROMASIDOR (KENYA) LIMITED**, a company duly incorporated in Kenya under the Companies Act, Chapter 486 Laws of Kenya of Suvida Complex, Beijing Road, off Mombasa Road, Mlolongo-Athi River, P.O. Box 10336 - 00100, Nairobi, Kenya

(740) Address for correspondence: **Chebets & Co. Advocates** of P.O. Box 3563 - 00506, Nairobi, Kenya

111) Mark number: **111682**

(540) Mark:



(511) Classes: **29, 30 & 32**

(730) Proprietor: **PROMASIDOR IP HOLDING LIMITED** of Ebene Junction, Rue de la Démocratie, Ebène, Mauritius

(791) Licensee: **PROMASIDOR (KENYA) LIMITED**, a company duly incorporated in Kenya under the Companies Act, Chapter 486 Laws of Kenya of Suvida Complex, Beijing Road, off Mombasa Road, Mlolongo-Athi River, P.O. Box 10336 - 00100, Nairobi, Kenya

(740) Address for correspondence: **Chebets & Co. Advocates** of P.O. Box 3563 - 00506, Nairobi, Kenya

11.4 Alteration of goods

(111) Mark number: **96588**

(730) Proprietor: **SUPERSOUND WOOFER LTD** of P.O. Box 7190 - 006100, Nairobi, Kenya

(511) Classes: **9 & 11**

(750) Address for service:

(580) The list of goods and services is amended so that henceforth it appears as shown here under:
9 (T.V speakers) and 11 (Blender and washing machine)

11.5 Surrender

(210) Application No: 70844

(220) Filing date: 24/03/2011

(511) Class: 37

(730) Applicant: NISSAN JIDOSHA KABUSHIKI KAISHA (also trading as Nissan Motor Co., Ltd.) a corporation organized and existing under the laws of Japan. of No. 2 Takaracho, Kanagawa-ku, Yokohama-shi, Kanagawa-ken, Japan

(740) Address for correspondence: Iseme, Kamau & Maema Advocates of P.O. Box 11866 - 00400, Nairobi, Kenya

(580) The list of goods and services is amended by partial surrender under rule 84 so that henceforth it appears as shown here under:



37(Repair or maintenance of automobiles, electric vehicles including electric automobiles, wagons, trucks, vans, sport utility vehicles, buses, recreational vehicles (RV), sports cars, racing cars, lorries, fork lift trucks, and towing tractors (tractors), and structural parts and fittings therefor; providing information about repair or maintenance of automobiles, electric vehicles, including electric automobiles, wagons, trucks, vans, sport utility vehicles, buses, recreational vehicles (RV), sports cars, racing cars, lorries, fork lift trucks, and towing tractors (tractors), and structural parts and fittings therefor, repair or maintenance of measuring or testing machines and instruments, repair or maintenance of power distribution or control machines and apparatus, repair or maintenance of rotary converters, repair or maintenance of phase modifier, repair or maintenance of chargers, repair or maintenance of batteries and cells, repair or maintenance of internal combustion engines, repair or maintenance of parts of internal combustion engines, repair or maintenance of starters for motors and engines, not for land vehicles, repair or maintenance of parts for AC motors and DC motors, repair or maintenance of AC generators and DC generators, repair or maintenance of power generators, repair or maintenance of electric wires or cables, repair or maintenance of telecommunication devices and apparatus, repair or maintenance of telephone apparatus, repair or maintenance of parts and accessories for telecommunication machines and apparatus, repair and maintenance of telematics apparatus for vehicles, repair or maintenance of charge completion automatic notification apparatus, repair or maintenance of vehicle navigation systems, repair or maintenance of electronic machines, apparatus, and their parts, repair or maintenance of personal computers, repair or maintenance of remote control systems, repair or maintenance of electrodes, repair or maintenance of magnetic cores, repair or maintenance of resistance wires.)

11.6 Madrid Applications accepted for registration

The following are the marks whose international registration has been notified to Kenya as a designated contracting Party by the International Bureau, World Intellectual Property Organization (WIPO) and which are governed by the Madrid Agreement and the Madrid Protocol. The prescribed period of twelve (12) months and eighteen months (18) respectively for refusal of the marks commences from the notification date indicated herein for each mark.

NOTICE is given that any person who has grounds of opposition to the registration of any of the marks may, in accordance with the provisions of rule 11(1) of the Trade Marks (International Registration) Rules 2003, file a notice of opposition within sixty (60) days from the date of this Journal on form TM. No. 6 (in duplicate) together with a fee of Ksh 5,000/= (Kenyan residents) or US\$ 250 (non residents).

The period of filing the notice of opposition may be extended by the Registrar of Trade Marks as prescribed in the Trade Mark Rules. Any request for such extension should be made to the Registrar before the expiry of the sixty (60) day statutory period.

All the details of the marks advertised herein are available on WIPO's website www.wipo.int/romarin

(210): 469344 (151): 02/09/2022 (511): 30 (732): PERFETTI VAN MELLE S.P.A. of Via XXV Aprile, 7 LAINATE (MI) I-20045, Italy	CENTER FRUIT
(210): 610406 (151): 12/09/2022 (511): 1 (732): STÉ COMPAGNIE FINANCIÈRE ET DE PARTICIPATIONS ROULLIER S.A., Société anonyme of 27, avenue Franklin Roosevelt, B.P. 158, F-35408 SAINT-MALO Cedex, France	SULFAMMO
(210): 679971 (151): 12/09/2022 (511): 1 (732): CIE FINANCIERE ET DE PARTICIPATIONS ROULLIER Société anonyme of 27, avenue Franklin Roosevelt F-35400 SAINT-MALO, France	PHYSIOLITH
(210): 700715 (151): 07/11/2022 (511): 5 (732): ALMIRALL S.A. of Ronda General Mitre, 151 E-08022 Barcelona, Spain	ALMOGRAN
(210): 717129 (151): 09/09/2022 (511): 6, 11, 17, 19 and 42 (732): Vacono Aluminium Covers GmbH of Friedrichstrasse 50 79618 Rheinfelden, Germany	VACONO
(210): 735519 (151): 06/06/2000 (511): 5 (732): Bayer S.A.S. of 16, rue Jean-Marie Leclair F-69009 LYON, France	ATLANTIS
(210): 744146 (151): 25/09/2000 (511): 5 (732): Bayer Intellectual Property GmbH of Alfred-Nobel-Straße 10 40789 Monheim am Rhein, Germany	LEVITRA
(210): 763794 (151): 10/08/2022 (511): 5 (732): Abbott Products Operations AG of Hegenheimerweg 127 CH-4123 Allschwil, Switzerland	Creon
(210): 784713 (151): 21/06/2002 (511): 1 and 5 (732): Bayer Intellectual Property GmbH of Alfred-Nobel-Straße 10 40789 Monheim am Rhein, Germany	INFINITO
(210): 785256 (151): 19/07/2002 (511): 1 and 5 (732): Bayer Intellectual Property GmbH of Alfred-Nobel-Straße 10 40789 Monheim am Rhein, Germany	SIVANTO
(210): 787730 (151): 18/06/2004 (511): 5 (732): Bayer Intellectual Property GmbH of Alfred-Nobel-Straße 10 40789 Monheim am Rhein, Germany	XARELTO
(210): 792625 (151): 06/11/2002 (511): 1 and 5 (732): Syngenta Limited of Syngenta Jealott's Hill, International Research Centre Bracknell, Berkshire, RG42 6EY, United Kingdom	ACTELIC
(210): 835227 (151): 11/06/2004 (511): 5 (732): Bayer Aktiengesellschaft of Kaiser-Wilhelm-Allee 51373 Leverkusen, Germany	NEXAVAR
(210): 870198 (151): 29/09/2022 (511): 3, 4 and 35 (732): DIPTYQUE S.A.S. of 34, boulevard Saint-Germain F-75005 PARIS, France	DIPTYQUE

(210): 888588 (151): 12/09/2022 (511): 1 and 31 (732): COMPAGNIE FINANCIERE ET DE PARTICIPATIONS ROULLIER of 27 avenue Franklin Roosevelt F-35400 SAINT-MALO, France	SEACTIV
(210): 889961 (151): 04/10/2022 (511): 10, 17 and 20 (732): Greiner Bio-One GmbH of Bad Haller Straße 32 A-4550 Kremsmünster, Austria	QUICK SHIELD
(210): 892058 (151): 04/10/2022 (511): 10 (732): Medela Holding AG of Lättichstrasse 4b CH-6340 Baar, Switzerland	FREESTYLE
(210): 906281 (151): 06/10/2022 (511): 4 (732): UNIL OPAL of Boulevard Jean Moulin F-49400 SAUMUR, France	UNIL OPAL
(210): 906297 (151): 06/10/2022 (511): 1 (732): COMPAGNIE FINANCIERE ET DE PARTICIPATIONS ROULLIER of 27 avenue Franklin Roosevelt F-35400 SAINT-MALO, France	KSC PHYT-ACTYL
(210): 912848 (151): 15/06/2022 (511): 1 (732): K+S Minerals and Agriculture GmbH of Bertha-von-Suttner- Straße 7 34131 Kassel, Germany	Korn-Kali
(210): 990921 (151): 17/06/2019 (511): 6, 7, 9, 12, 19, 35, 37, 39, 41 and 42 (732): Innova Patent GmbH of Konrad-Doppelmayr-Strasse 1 A-6922 Wolfurt, Austria	Doppelmayr
(210): 1006155 (151): 01/11/2022 (511): 3 (732): BIOTA BITKISEL İLAÇ VE KOZMETİK LABORATUARLARI A.S. of Emek Mah. Sivak Yolu Cad. No:9 Sancaktepe Istanbul, Turkey	BIOXCIN
(210): 1069893 (151): 12/09/2022 (511): 1 (732): COMPAGNIE FINANCIERE ET DE PARTICIPATIONS ROULLIER of 27 avenue Franklin Roosevelt F-35400 SAINT-MALO, France	TOP-PHOS
(210): 1071048 (151): 22/07/2022 (511): 5, 7, 11, 21, 32 and 40 (732): BRITA SE of Heinz-Hankammer-Strasse 1 65232 Taunusstein, Germany	BRITA
(210): 1096120 (151): 11/08/2022 (511): 9, 15, 16, 18, 25, 41 and 43 (732): Billboard IP Holdings, LLC of 340 Madison Avenue New York NY 10173, United States of America	BILLBOARD
(210): 1096193 (151): 06/09/2022 (511): 1, 29 and 30 (732): PURATOS of Industrialaan 25 B-1702 Groot-Bijgaarden, Belgium	SATIN
(210): 1118310 (151): 15/03/2022 (511): 5 (732): Valent BioSciences LLC of 1910 Innovation Way, Suite 100 Libertyville IL 60048, United States of America	XENTARI
(210): 1126365 (151): 03/08/2022 (511): 1 (732): AGRITECNO FERTILIZANTES, S.L. of Paseo de Ruzafa 20, 4° -1 E-46002 Valencia, Spain	AGRIFUL
(210): 1129596 (151): 30/06/2022 (511): 3 and 5 (732): Gecomwert Anstalt c/o Schreiber & Zindel of Kirchstrasse 39 FL-9490 Vaduz, Liechtenstein	FILLERINA

(210): 1164824 (151): 04/10/2022
 (511): 5, 10 and 20
 (732): Greiner Bio-One GmbH of Bad Haller Straße 32 A-4550
 Kremsmünster, Austria

GREINER BIO-ONE

(210): 1207436 (151): 18/07/2022
 (511): 5, 29 and 30
 (732): VBAND LLC of 1120 20th Street, NW, Suite S-300 Washington,
 DC 20035, United States of America



(210): 1212645 (151): 04/10/2022
 (511): 1, 5, 9 and 10
 (732): Greiner Bio-One GmbH of Bad Haller Straße 32 A-4550
 Kremsmünster, Austria



(210): 1253612 (151): 20/06/2022
 (511): 3 and 18
 (732): SOCIETE PARISIENNE DE PARFUMS ET COSMETIQUES of 11, rue
 Margueritte F-75017 PARIS, France

WRITER

(210): 1357418 (151): 31/08/2022
 (511): 3, 5 and 10
 (732): Relife S.r.l. of Via dei Sette Santi, 3 I-50131 Firenze, Italy



(210): 1360187 (151): 31/08/2022
 (511): 3, 5 and 10
 (732): Relife S.r.l. of Via dei Sette Santi, 3 I-50131 Firenze, Italy



(210): 1395061 (151): 06/10/2022
 (511): 7, 11 and 30
 (732): RANCILIO GROUP S.P.A. of Viale della Repubblica, 40,
 Frazione Villastanza I-20015 Parabiago (Milano), Italy

RANCILIO

(210): 1403978 (151): 20/09/2022
 (511): 29 and 30
 (732): YAMAKI Co., Ltd. of 1698-6, Kominato, Iyo-shi 799-3194
 Ehime, Japan



(210): 1421212 (151): 10/11/2022
 (511): 34
 (732): Swedich Match North Europe AB of SE-118 85 Stockholm,
 Sweden

ZYN

(210): 1444094 (151): 14/10/2022
 (511): 9, 36, 41 and 42
 (732): Stiftung Ethereum (Foundation Ethereum) of Zeughausgasse
 7a CH-6300 Zug, Switzerland

ETHEREUM

(210): 1446499 (151): 10/10/2022
 (511): 3
 (732): Beiersdorf AG of Unnastr. 48 20253 Hamburg, Germany

LUMINOUS 630

(210): 1456681 (151): 11/11/2022
 (511): 34
 (732): Swedish Match North Europe AB of SE-118 85 Stockholm,
 Sweden



(210): 1481228 (151): 29/09/2022
 (511): 9
 (732): SHENZHEN GROWATT NEW ENERGY CO., LTD. of 4-13/F,
 Building A, Sino-German (Europe) Industrial Park, Hangcheng Ave,
 Bao'an District Shenzhen, China

GROWATT

(210): 1494680 (151): 27/09/2022
 (511): 1, 2, 6, 7, 8, 9, 16, 17, 19, 20, 24, 27, 35, 37, 39 and 42
 (732): DAW SE of Rossdörfer Str. 50 64372 Ober-Ramstadt, Germany



(210): 1498911 (151): 01/07/2022
 (511): 30
 (732): Obshchestvo s ogranichennoy otvetstvennostyu "Vologodskoe Morozhenoe" of ul. Klubova, d. 87 g. Vologda RU-160021 Vologodskaya obl., Russian Federation



(210): 1514779 (151): 13/10/2022
 (511): 5 and 42
 (732): Saviela AG of Blegistrasse 17A CH-6340 Baar, Switzerland



(210): 1518463 (151): 01/09/2022
 (511): 29 and 30
 (732): Obshchestvo s ogranichennoy otvetstvennostyu Holding «AMAR GRUPP» of ul. Chekistov, d. 191, kab. 1, pos. Zubchaninovka RU-443044 Samara, Samarskaya obl., Russian Federation



(210): 1523134 (151): 06/09/2022
 (511): 29 and 30
 (732): PURATOS of Industrialaan 25 B-1702 Groot-Bijgaarden, Belgium

SMOOBES

(210): 1525801 (151): 30/09/2022
 (511): 3 and 4
 (732): DIPTYQUE S.A.S. of 34 boulevard Saint Germain F-75005 Paris, France



(210): 1537818 (151): 30/09/2022
 (511): 9
 (732): JVCKENWOOD Corporation of 3-12, Moriyacho, Kanagawa-ku, Yokohama-shi Kanagawa 221-0022, Japan

KENWOOD

(210): 1546220 (151): 15/09/2022
 (511): 5
 (732): Tianjin Zhongxin Pharmaceutical Group Corporation Limited Lerentang Pharmaceutical Factory of No. 2, DaMing Road, XiQing District Tianjin, China

長城牌



GREAT WALL BRAND

(210): 1548571 (151): 28/09/2022
 (511): 9, 35, 38, 42, 44 and 45
 (732): Curalie GmbH of Leipziger Straße 61A 10117 Berlin, Germany



(210): 1548791 (151): 10/10/2022
 (511): 9, 35, 38, 42, 44 and 45
 (732): Curalie GmbH of Leipziger Straße 61A 10117 Berlin, Germany



O-tentic

(210): 1560691 (151): 06/09/2022
 (511): 1 and 30
 (732): PURATOS of Industrialaan 25 B-1702 Groot-Bijgaarden, Belgium

(210): 1568540 (151): 25/10/2022
 (511): 3 and 5
 (732): AKSAN KOZMETIK SANAYI VE TICARET ANONIM SIRKETI of Deliklikaya Mah., Kisikli Cad. 23 -25A Arnavutköy/Istanbul, Turkey



(210): 1569278 (151): 14/10/2022
 (511): 36
 (732): AxiCorp Financial Services Pty Ltd of Level 10, 90 Arthur Street North Sydney NSW 2060, Australia



(210): 1572543 (151): 12/10/2022
 (511): 1 and 42
 (732): TOOPI ORGANICS of Lieu-dit aux Halles, Zone Artisanale Ecopole F-33190 LOUPIAC-DE-LA-REOLE, France

TOOPI

(210): 1575081 (151): 12/09/2022
 (511): 1, 5 and 31
 (732): COMPAGNIE FINANCIERE ET DE PARTICIPATIONS ROULLIER of 27, avenue Franklin Roosevelt F-35400 SAINT-MALO, France



(210): 1581336 (151): 31/08/2022
 (511): 7 and 37
 (732): Weir Engineering Services Limited of 20 Waterloo Street Glasgow G2 6DB, United Kingdom

WEIR

(210): 1585659 (151): 08/08/2022
 (511): 9 and 35
 (732): JACKERY INC. of 48531 WARM SPRINGS BLVD 408 FREMONT CA 94539-7793, United States of America

Jackery

(210): 1603914 (151): 14/10/2022
 (511): 9, 36, 41 and 42
 (732): Stiftung Ethereum (Foundation Ethereum) of Zeughausgasse 7a CH-6300 Zug, Switzerland



(210): 1618714 (151): 03/10/2022
 (511): 9
 (732): Obshchestvo s ogranichennoy otvetstvennostyu nauchno-proizvodstvennoye predpriyatiye "TEPLOVODOKHRAN" of Novaya str, 51V, Letter «Zh», nezh. pom. H2 RU-390027 Ryazan, Ryazanskaya oblast, Russian Federation



(210): 1629652 (151): 12/08/2022
 (511): 9
 (732): GENEVERSE ENERGY INC. of 48531 Warm Springs Blvd, Ste 413 Fremont CA 94539, United States of America

GENEVERSE

(210): 1630334 (151): 12/10/2022
 (511): 3, 4, 8, 18 and 21
 (732): EUROITALIA S.R.L. of Via Galileo Galilei, 5 I-20873 Cavenago di Brianza (MB), Italy

ATKINSONS

(210): 1641904 (151): 10/11/2022

(511): 25

(732): FLO MAGAZACILIK VE PAZARLAMA ANONIM SIRKETI of Merkez Mah. Tasocagi Cad. No:24 Kat:3, Mahmutbey Bagcilar Istanbul, Turkey



SALVANO

(210): 1643435 (151): 12/10/2022

(511): 3, 4, 8, 18 and 21

(732): EUROITALIA S.R.L. of Via Galileo Galilei, 5 I-20873 Cavenago di Brianza (MB), Italy



ATKINSONS

LONDON 1799

(210): 1643627 (151): 12/10/2022

(511): 3, 4, 8, 18 and 21

(732): EUROITALIA S.R.L. of Via Galileo Galilei, 5 I-20873 Cavenago di Brianza (MB), Italy



(210): 1643814 (151): 13/10/2022

(511): 10

(732): Shenzhen Lifotronic Technology Co., Ltd. of 1st Floor, Jindi Tianyue Bay (Intersection of Meiguan Expressway and Huanguan South Road), No. 8 Qiuzhi East Road, Guancheng Community, Guanhu Street 518110 Longhua, China

Lifotronic

(210): 1653013 (151): 10/11/2022

(511): 3

(732): Zino Davidoff SA of Sternengasse 18 CH-4051 Basel, Switzerland

Cool Water

REBORN

(210): 1653450 (151): 10/08/2022

(511): 21

(732): Enagic Europe GmbH of Immermannstr. 33 40210 Düsseldorf, Germany

Change Your Water
Change Your Life

(210): 1655131 (151): 09/09/2022

(511): 3

(732): Star Brands Limited of Suite 1, 1175 Century Way, Thorpe Park Leeds, West Yorkshire LS15 8ZB, United Kingdom

THE PINK STUFF

(210): 1656423 (151): 06/09/2022

(511): 1 and 30

(732): Chr. Hansen A/S of Bøge Allé 10-12 DK-2970 Hørsholm, Denmark

SMARTBEV

(210): 1657439 (151): 14/09/2022

(511): 3, 5 and 35

(732): Holland & Barrett International Limited of Samuel Ryder House, Barling Way, Eliot Park Nuneaton, Warwickshire CV10 7RH, United Kingdom



SESAMI

(210): 1659242 (151): 10/02/2022

(511): 36 and 42

(732): Garda CL Technical Services, Inc. of 2000 NW Corporate Boulevard Boca Raton FL 33431, United States of America

(210): 1668519 (151): 20/04/2022

(511): 9

(732): Honor Device Co., Ltd. of Suite 3401, Unit A, Building 6, Shum Yip Sky Park, No. 8089, Hongli West Road, Xiangmihu Street, Futian District, Shenzhen 518040 Guangdong, China

HONOR Health

(210): 1675117 (151): 01/06/2022
(511): 9, 16 and 42
(732): WEKA MEDIA PUBLISHING GmbH of Richard-Reitzner Allee 2
85540 Haar, Germany

connect

(210): 1677661 (151): 06/07/2022
(511): 33
(732): Jack Daniel's Properties, Inc. of 4040 Civic Center Drive,
Suite 528 San Rafael CA 94903, United States of America



(210): 1679051 (151): 30/06/2022
(511): 1 and 5
(732): Nichino Europe Co., Ltd. of 5 Pioneer Court, Vision Park
Histon, Cambridge CB24 9PT, United Kingdom

VERDASOL

(210): 1679521 (151): 07/07/2022
(511): 18 and 25
(732): Deichmann SE of Deichmannweg 9 45359 Essen, Germany



(210): 1679884 (151): 05/07/2022
(511): 9 and 42
(732): BEIJING XIPULIN TRADING CO., LTD of 412-5, WEST DISTRICT,
4TH FLOOR, NO. 11 ZHUSHIKOU STREET, DONGCHENG DISTRICT
100062 BEIJING, China



(210): 1679885 (151): 05/07/2022
(511): 9
(732): BEIJING XIPULIN TRADING CO., LTD of 412-5, WEST DISTRICT,
4TH FLOOR, NO. 11 ZHUSHIKOU STREET, DONGCHENG DISTRICT
100062 BEIJING, China



(210): 1679934 (151): 06/07/2022
(511): 3
(732): Rivages du Nord of 5 avenue de la Princesse Lalla Meryem
Soussi Rabat, Morocco

AL BOURAN

(210): 1679935 (151): 08/07/2022
(511): 25
(732): Eton AB of Stora vägen 8 SE-507 71 Gånghester, Sweden

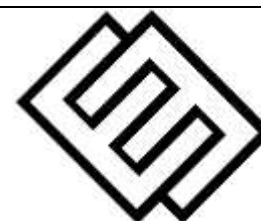

(210): 1679967 (151): 21/07/2022
(511): 9, 36 and 42
(732): Pepperstone Group Limited of Level 16, Tower One, 727
Collins Street Docklands VIC 3008, Australia



(210): 1680246 (151): 20/06/2022

(511): 9

(732): Shenzhen Heiston Photoelectric Technology Co., Ltd of 401, Building G, No. 17, Xintian Community Innovation Industrial Park, Guanhu Street, Longhua District, Shenzhen Guangdong, China



(210): 1680250 (151): 21/06/2022

(511): 9

(732): Shenzhen Tozo Technology Limited of Room 402, Education Industry Building, District 71, Xingdong Community, Xin'an Street, Bao'an District 518000 Shenzhen, China

Truesonic

(210): 1680271 (151): 13/07/2022

(511): 20

(732): Foshan Sitzone Furniture Co.,Ltd. of No.8, Chaohai Road, Xiqing Village, Longjiang Town, Shunde District, Foshan City Guangdong Province, China



(210): 1680615 (151): 27/06/2022

(511): 9

(732): SOUNDKING ELECTRONICS & SOUND CO.,LTD of No.818 Chengxin Road, Yinzhou District, Ningbo City 315000 Zhejiang Province, China



(210): 1680646 (151): 27/06/2022

(511): 7, 9, 12, 37, 39 and 42

(732): Opibus AB of Filip Gardler Åsögatan 166 SE-116 32 Stockholm, Sweden

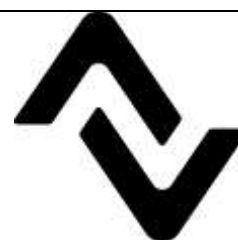

(210): 1680657 (151): 28/06/2022

(511): 9

(732): King.com Limited of Aragon House Business Centre, Dragonara Road STJ 3140 ST. JULIANS, Malta

REBEL RIDERS

(210): 1680683 (151): 05/07/2022

(511): 9

(732): BEIJING XIPULIN TRADING CO., LTD of 412-5, WEST DISTRICT, 4TH FLOOR, NO. 11 ZHUSHIKOU STREET, DONGCHENG DISTRICT 100062 BEIJING, China



(210): 1680746 (151): 29/06/2022

(511): 7

(732): Kleemann GmbH of Manfred-Wörner-Str. 160 73037 Göppingen, Germany

MOBIREX NEO

(210): 1680758 (151): 22/06/2022

(511): 34

(732): Imiracle (ShenZhen) Technology Co., Ltd. of Room 1203, Block 1, Wanting Building, Xixiang Subdistrict, Bao'an District, Shenzhen Guangdong, China



ELFBAR

(210): 1680865 (151): 21/06/2022

(511): 39

(732): China Cargo Airlines Ltd. of No. 1279 Hangcheng Road, Jichang Zhen, Pudong New District Shanghai, China



(210): 1680878 (151): 01/07/2022

(511): 10

(732): Genrui Biotech Inc. of 4-10F, Building 3, Geya Technology Park, Guangming District, Shenzhen 518106 Guangdong, China



(210): 1681154 (151): 04/07/2022

(511): 5

(732): Qingdao United Dairy Co., Ltd. of Building 8103-1-2(A), IF, Qianyantong Office Building, No. 44, Moskva Road, Qianwan Bonded Port Area, Qingdao Area 266555 China (Shandong) Pilot Free Trade Zone, China

applac

(210): 1681157 (151): 04/07/2022

(511): 6

(732): GUANGDONG HEGU HARDWARE PRECISION MANUFACTURE CO., LTD. of Jiayang Industrial Transfer Industrial Park, North Of Zhishui Street East Of Zhaohui Road, China

思造SEZAO

(210): 1681200 (151): 24/06/2022

(511): 9 and 17

(732): Guangdong Mcdodo Industrial Co., Ltd. of Room 3402, Building A, No. 30 Tianhe Straight Road, Tianhe Dist, Guangzhou Guangdong, China

Mcdodo

(210): 1681267 (151): 05/07/2022

(511): 34

(732): Dongguan Williams Technology Co., Ltd. of Room 803, No.228 Chang 'an Zhen 'an Mid Road, Chang 'an Town, Dongguan Guangdong, China



(210): 1681424 (151): 15/06/2022

(511): 42

(732): Webb Fontaine Group FZ-LLC of Concord tower, Office 712, PO Box 502793, Dubai Media City Dubai, United Arab Emirates

Paylican Invoice

(210): 1681428 (151): 15/06/2022

(511): 42

(732): Webb Fontaine Group FZ-LLC of Concord tower, Office 712, PO Box 502793, Dubai Media City Dubai, United Arab Emirates

Paylican Gateway

(210): 1681721 (151): 24/06/2022

(511): 1 and 5

(732): Andermatt Group AG of Stahlermatten 6 Grossdietwil CH-6146, Switzerland

TUMARA

(210): 1681811 (151): 30/06/2022

(511): 3

(732): Parfums Christian Dior of 33 avenue Hoche F-75008 Paris, France

**DIOR
SNOW**

(210): 1681823 (151): 15/06/2022

(511): 42

(732): Webb Fontaine Group FZ-LLC of Concord tower, Office 712, PO Box 502793, Dubai Media City Dubai, United Arab Emirates

Webb Inspection

(210): 1681882 (151): 15/06/2022

(511): 42

(732): Webb Fontaine Group FZ-LLC of Concord tower, Office 712, PO Box 502793, Dubai Media City Dubai, United Arab Emirates

Webb Risk Intelligence

(210): 1682213 (151): 30/06/2022

(511): 35

(732): Xiamen C&D Corporation Limited of 43/F, C&D International Building, No.1699 Huandao East Road, Siming District, Xiamen City 361008 Fujian Province, China

建发

(210): 1682214 (151): 30/06/2022

(511): 35

(732): Xiamen C&D Corporation Limited of 43/F, C&D International Building, No.1699 Huandao East Road, Siming District, Xiamen City 361008 Fujian Province, China

C&D

(210): 1682385 (151): 22/06/2022
 (511): 41 and 45
 (732): FELLOWSHIP OF CHRISTIAN ATHLETES of 8701 Leeds Road
 Kansas City MO 64129, United States of America



(210): 1682574 (151): 05/07/2022
 (511): 13
 (732): SARSILMAZ SILAH SANAYI ANONIM SİRKETİ of İstiklal OSB1
 Mah. 5 Cad. 12 0 Merkez Duzce, Turkey



(210): 1682614 (151): 20/06/2022
 (511): 34
 (732): Shanghai Tobacco Group Beijing Cigarette Factory Co.,Ltd.
 of No. 99, WanSheng NanJie TongZhou District 101121 Beijing, China



(210): 1682676 (151): 23/06/2022
 (511): 11 and 20
 (732): ZHONGSHAN FRAE SHOWER EQUIPMENT CO.,LTD of Jianye
 2nd Road, Shalang, West District, Zhongshan Guangdong Province,
 China



(210): 1682693 (151): 06/07/2022
 (511): 9
 (732): Huizhong Instrumentation Co., Ltd of No. 126 West Gaoxin
 Road, High Tech Industrial Development Zone, Tangshan 063000
 Hebei, China



(210): 1683039 (151): 08/11/2022
 (511): 29
 (732): Dreamfarm Società a responsabilità limitata Società Benefit
 of Via Galeotti 2 I-43038 Sala Baganza (PR), Italy



(210): 1683145 (151): 27/06/2022
 (511): 9 and 15
 (732): SOUNDKING ELECTRONICS & SOUND CO.,LTD of No.818
 Chengxin Road, Yinzhou District, Ningbo City 315000 Zhejiang
 Province, China



(210): 1683164 (151): 30/06/2022
 (511): 31
 (732): Xiuwen County Kiwi Fruit Association of Longchang Town,
 Xiuwen County, Guiyang City Guizhou Province, China



(210): 1683264 (151): 17/06/2022
 (511): 35 and 39
 (732): TÜRKİYE TURİZM TANITIM VE GELİSTİRME AJANSI of Esentepe
 Mahallesi, Büyükdere Caddesi, Astoria 127 B/71 Sisli Istanbul,
 Turkey



(210): 1683469 (151): 20/06/2022
 (511): 34
 (732): Shanghai Tobacco Group Beijing Cigarette Factory Co.,Ltd.
 of No. 99, WanSheng NanJie TongZhou District 101121 Beijing, China



(210): 1683485 (151): 08/07/2022
 (511): 11
 (732): ZHONGSHAN HUAYI LIGHTING CO., LTD. of Huayi Industrial
 Park, Dongxing East Road, Guzhen Town, Zhongshan City Guangdong
 Province, China

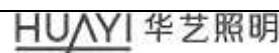

(210): 1683915 (151): 16/05/2022

(511): 9

(732): Victron Energy B.V. of De Paal 35 NL-1351 JG Almere, Netherlands

BlueSolar

(210): 1684034 (151): 01/07/2022

(511): 12

(732): BYD COMPANY LIMITED of No. 1, Yan'an Road, Kuichong Street, Dapeng New District, Shenzhen Guangdong, China

Sea Lion

(210): 1684537 (151): 22/06/2022

(511): 9, 19, 35 and 42

(732): Holcim Technology Ltd of Grafenauweg 10 CH-6300 Zug, Switzerland

CLICKIT

(210): 1684941 (151): 13/07/2022

(511): 42

(732): GeoX Energy Inc. of 450 Alaskan Way, Suite 200 Seattle WA 98104, United States of America

GEOX

(210): 1685128 (151): 29/09/2022

(511): 35 and 44

(732): Clinique Laboratories, LLC of 767 Fifth Avenue New York NY 10153, United States of America

**CLINIQUE
LABORATORIES**

(210): 1685267 (151): 28/06/2022

(511): 28 and 41

(732): Mikasa Corporation of 1, Kuchi, Asa-cho, Asakita-ku, Hiroshima-shi Hiroshima-ken 731-3362, Japan

**CHALLENGE TO DO
MORE**

(210): 1685775 (151): 07/07/2022

(511): 11

(732): Guangzhou Canmei Lighting Co., Ltd. of 2056, No.544 Yayun Avenue, Dalong Street, Panyu District, Guangzhou City 510000 Guangdong Province, China

CANMEIJIA

(210): 1685782 (151): 18/07/2022

(511): 12

(732): SHANGHAI JIDU AUTOMOBILE CO., LTD. of Building 2, No. 1688 Yecheng Road, Jiading District 200000 Shanghai, China

集度

(210): 1686653 (151): 28/06/2022

(511): 3

(732): DOLCE & GABBANA TRADEMARKS S.r.l. of VIA GOLDONI 10 I-20129 MILANO (IT), Italy



DOLCE & GABBANA

(210): 1686677 (151): 08/07/2022

(511): 29, 31, 41 and 42

(732): Svampsson Holding AB of Gruvgatan 39B SE-411 14 Göteborg, Sweden

Millow

(210): 1686833 (151): 21/06/2022

(511): 9 and 35

(732): Brzhezyskyi Valentyn Valentynovych of Vul. Akademika Filatova, Bud. 34, Kv. 30 Odesa, 65080, Ukraine

YUUKI

(210): 1686890 (151): 08/07/2022

(511): 9

(732): GUANGDONG OPPO MOBILE TELECOMMUNICATIONS CORP., LTD. of No. 18 Haibin Road, Wusha, Chang'an, Dongguan Guangdong, China

OPPO Connect

(210): 1686946 (151): 12/07/2022

(511): 7 and 11

(732): LA MARZOCCO S.r.l. of Via La Torre 14/H I-50038 SCARPERIA E SAN PIERO, Italy



(210): 1687170 (151): 22/06/2022
 (511): 7, 8 and 9
 (732): Zhejiang Shijing Tools Co.,Ltd. of No.1, Weiwu West Road,
 Tongqin Town, Wuyi County, Jinhua City Zhejiang, China

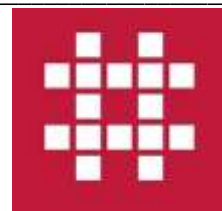

healthmass

(210): 1687261 (151): 12/07/2022
 (511): 7, 8 and 9
 (732): Zhejiang Ankexin Hardware Tools Co., LTD of Caizhai Village,
 Hulu Town, Dongyang City Zhejiang Province, China

(210): 1687416 (151): 07/07/2022
 (511): 33

(732): NOBLEWOOD LIMITED of Arch. Makariou III, 206, CHRYSALIA
 COURT, 5TH Floor CY-3030 Limassol, Cyprus

FINE DE CLAIRE

(210): 1687479 (151): 03/08/2022
 (511): 18

(732): Shenzhen Stonger Sports Technology Co., LTD of 102, Jinfulai
 Complex Building, 49-1 Dabao Road, Dalang Community, Xin'an
 Street, Bao'an District, Shenzhen 518000 Guangdong, China

Waterfly

(210): 1687629 (151): 25/08/2022
 (511): 9

(732): Apple Inc. of One Apple Park Way Cupertino CA 95014,
 United States of America



(210): 1687760 (151): 07/07/2022
 (511): 33

(732): NOBLEWOOD LIMITED of Arch. Makariou III, 206, CHRYSALIA
 COURT, 5TH Floor CY-3030 Limassol, Cyprus

NOBLEWOOD

(210): 1687761 (151): 07/07/2022
 (511): 33

(732): NOBLEWOOD LIMITED of Arch. Makariou III, 206, CHRYSALIA
 COURT, 5TH Floor CY-3030 Limassol, Cyprus

CASA DEL LOROS

(210): 1687762 (151): 15/08/2022
 (511): 33

(732): The Absolut Company Aktiebolag of SE-117 97 Stockholm,
 Sweden

BORN TO MIX

(210): 1687813 (151): 08/07/2022
 (511): 32 and 33

(732): COINTREAU of Carrefour Molière F-49124 SAINT-
 BARTHELEMY-D'ANJOU, France



Miar

(210): 1687895 (151): 03/08/2022
 (511): 1 and 5

(732): Albaugh tovarna kemernih izdelkov d.o.o. of Grajski trg 21 SI-
 2327 Race, Slovenia

Macklynn

(210): 1687896 (151): 03/08/2022
 (511): 1 and 5

(732): Albaugh tovarna kemernih izdelkov d.o.o. of Grajski trg 21 SI-
 2327 Race, Slovenia

(210): 1688071 (151): 08/07/2022
 (511): 7, 9, 12, 35, 37, 41, 42 and 44

(732): GUANGZHOU XAIRCRAFT TECHNOLOGY CO., LTD. of Block C,
 115 Gaopu Road, Tianhe District, Guangzhou Guangdong, China

XAG

(210): 1688079 (151): 10/08/2022**(511): 9****(732):** Huizhou Jiuzi Electronic Technology Co., Ltd. of Xiaotang, Shangnan Village, Yuanzhou Town, Boluo County, Huizhou City 516000 Guangdong Province, China

JERRZI**(210): 1688160 (151): 20/07/2022****(511): 9 and 42****(732):** HUAWEI TECHNOLOGIES CO., LTD. of Administration Building Huawei Technologies Co., Ltd. Bantian, Longgang District Shenzhen, China

HongMengOS**(210): 1688345 (151): 16/08/2022****(511): 28, 37, 38 and 41****(732):** Immersive Health Solutions LLC of 1209 Orange Street Wilmington DE 19801, United States of America

REALITY ONE**(210): 1688358 (151): 25/08/2022****(511): 35****(732):** Apple Inc. of One Apple Park Way Cupertino CA 95014, United States of America

**(210): 1688379 (151): 30/08/2022****(511): 42****(732):** WorldQuant, LLC of 1700 East Putnam Avenue, Third Floor Old Greenwich CT 06870, United States of America

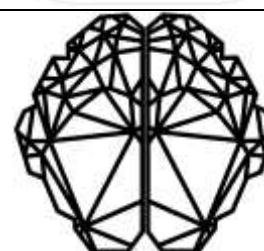
**(210): 1688432 (151): 04/08/2022****(511): 6 and 37****(732):** NIPPON STEEL CORPORATION of 6-1, Marunouchi 2-chome, Chiyoda-ku Tokyo 100-8071, Japan

**(210): 1688558 (151): 24/08/2022****(511): 3****(732):** Rohto Pharmaceutical Co., Ltd. of 8-1, Tatsuminishi 1 Chome, Ikuno-ku, Osaka-shi Osaka 544-8666, Japan

HADALABO**(210): 1688635 (151): 16/06/2022****(511): 29, 30 and 35****(732):** Wyke Farms Ltd of White House Farm, Wyke Champflower Bruton, Somerset BA10 0PU, United Kingdom

**(210): 1688658 (151): 26/07/2022****(511): 42 and 44****(732):** BGI Genomics Co., Ltd.; BGI PathoGenesis Pharmaceutical Technology Co., Ltd; WUHAN BGI CLINICAL LABORATORY CO., LTD of Floors 7-14, Building No. 7, BGI Park, No. 21 Hong'an 3rd Street, Yantian District, Shenzhen 518083 Guangdong, China; 0605A, Port Building of Marine Centre, No. 59 Linhai Avenue, Nanshan Street, Qianhai Shenzhen-Hong Kong Cooperation Zone, Shenzhen 518000 Guangdong, China; Building B2, Zone B, C and D, Wuhan National Biological Industry Base, No. 666 Gaoxin Road, Donghu Technology Development Zone, Wuhan Hubei, China



(210): 1688828 (151): 04/07/2022
 (511): 1, 3, 4, 7, 9, 10, 11 and 12
 (732): Halla Holdings Corporation of 46, Giheungdanji-ro, Giheung-gu, Yongin-si Gyeonggi-do, Republic of Korea

HL Mando

(210): 1688845 (151): 02/08/2022
 (511): 35 and 42
 (732): HIKARI (SHANGHAI) PRECISE MACHINERY SCIENCE & TECHNOLOGY CO., LTD. of NO.800 ZHONGDA ROAD, ZHUJING, JINSHAN DISTRICT 201500 SHANGHAI, China

HIKARI

(210): 1688877 (151): 16/09/2022
 (511): 2
 (732): Guangzhou Yinyu Technology Co., LTD of Room 301-A95, Floor 3, No.123 Dongjiao South Road, Liwan District, Guangzhou 510000 Guangdong, China

Ceres

(210): 1688957 (151): 01/07/2022
 (511): 1
 (732): EIShARK FOR TRADE AND INDUSTRY (Eagle for paints) of Part of Plot 233 and 234, /1,2, 2nd Industrial Zone, 6th of October City Giza, Egypt



(210): 1688985 (151): 08/08/2022
 (511): 19 and 20
 (732): FINANCIERA MADERERA, S.A. of Formarís s/n E-15707 Santiago de Compostela (A Coruña), Spain

FINSA

(210): 1688987 (151): 08/07/2022
 (511): 32 and 33
 (732): COINTREAU of Carrefour Molière F-49124 SAINT-BARTHELEMY-D'ANJOU, France



(210): 1689128 (151): 15/06/2022
 (511): 9, 25, 28 and 41
 (732): Kukua Education Limited of 80 Cheapside London EC2V 6EE, United Kingdom

SUPER SEMA

(210): 1689159 (151): 25/07/2022
 (511): 9, 28 and 41
 (732): Euro Games Technology Ltd. of 4, "Maritsa" Str. "Vranya-Lozen-Triugulnika" BG-1151 Sofia, Bulgaria

Book of Shining Hot

(210): 1689167 (151): 04/08/2022
 (511): 41
 (732): SHE LOVES TECH PRIVATE LIMITED of 109 NORTH BRIDGE ROAD #05-21 FUNAN SINGAPORE 179097, Singapore

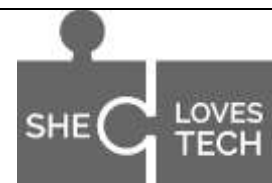

(210): 1689194 (151): 04/08/2022
 (511): 4, 7 and 37
 (732): ATLAS COPCO AIRPOWER, NV of Boomsesteenweg 957 B-2610 Wilrijk, Belgium

**Roto Inject Fluid
 NDURANCE**

(210): 1689326 (151): 02/05/2022

(511): 41

(732): FONDAZIONE DI RELIGIONE DON BOSCO NEL MONDO of VIA
MARSALA, 42 I-00185 ROMA, Italy



Don Bosco Global
Youth Film Festival

(210): 1689345 (151): 08/07/2022

(511): 5

(732): Novugen Pharma Sdn. Bhd. of No. 3, Jalan Jururancang
U1/21, Hicom Glenmarie Industrial Park 40150 Shah Alam Selangor,
Malaysia

NOVUGEN

(210): 1689437 (151): 15/08/2022

(511): 5

(732): QUANZHOU UNICARE HYGIENE PRODUCTS CO., LTD. of Xiayi
Village, Heshi Town, Luojiang District, Quanzhou City 362013 Fujian
Province, China



(210): 1689514 (151): 12/08/2022

(511): 5 and 10

(732): Shenzhen Tisenc Medical Devices Co., Ltd. of 11F, 11G,
Kechuang Building, Quanzhi Science and Innovation Park,
Maozhoushan Industrial Park, Houting Community, ShaJing Street,
BaoAn District 518104 ShenZhen, China

TISENC

(210): 1689555 (151): 16/08/2022

(511): 42

(732): Apple Inc. of One Apple Park Way Cupertino CA 95014,
United States of America

CARPLAY

(210): 1689741 (151): 02/06/2022

(511): 9, 16, 35, 36, 39 and 42

(732): LA POSTE of 9 rue du Colonel Pierre Avia F-75015 PARIS,
France



SYMPULSE

(210): 1689862 (151): 04/07/2022

(511): 9, 35, 38, 41 and 42

(732): Rakuten Mobile, Inc. of 1-14-1 Tamagawa, Setagaya-ku Tokyo
158-0094, Japan

WELLINGTON

(210): 1689880 (151): 27/07/2022

(511): 9, 16, 25 and 41

(732): Wellington School 1837 of Wellington School, South Street
WELLINGTON, Somerset TA21 8NT, United Kingdom

(210): 1689906 (151): 10/08/2022

(511): 7, 9, 12, 35 and 37

(732): GAC AION NEW ENERGY AUTOMOBILE CO., LTD. of No.36,
Longying Road, Panyu District, Guangzhou 511400 Guangdong, China

AION

(210): 1690010 (151): 15/08/2022

(511): 14

(732): Montres Tudor SA of Rue François-Dussaud 3 CH-1211 Genève
26, Switzerland

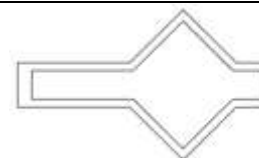

**NIVEA FRESH
SENSATION**

(210): 1690370 (151): 28/09/2022

(511): 3



(732): Beiersdorf AG of Unnastr. 48 20253 Hamburg, Germany

(210): 1690631 (151): 15/08/2022

(511): 3, 5 and 10

(732): HISAMITSU PHARMACEUTICAL CO., INC. of 408,
Tashirodaikan-machi, Tosu-shi Saga 841-0017, Japan



<p>(210): 1691429 (151): 25/07/2022 (511): 10 (732): Bausch & Lomb Incorporated of 1400 N. GOODMAN STREET, ROCHESTER NY 14609, United States of America</p>	<p>ENVISTA ENVY</p>
<p>(210): 1691521 (151): 24/08/2022 (511): 34 (732): Sichuan Sanlian New Materials Co., Ltd. of No.280, Yizhou Avenue North Section, Hi-tech Zone, Chengdu Sichuan, China</p>	
<p>(210): 1691579 (151): 21/07/2022 (511): 9, 36 and 42 (732): Pepperstone Group Limited of Level 16, Tower One, 727 Collins Street Docklands VIC 3008, Australia</p>	
<p>(210): 1691597 (151): 17/08/2022 (511): 18 (732): Fujian Yongjian Leather Technology Co., Ltd. of No.10 Dongfu Road, Jinjiang City, Quanzhou City Fujian Province, China</p>	<p>永 建 YONGJIAN</p>
<p>(210): 1691630 (151): 16/08/2022 (511): 1, 5 and 10 (732): Hunan Arshine Pharmaceutical Co., Limited of 5th floor, Building 14, Xinggong International Park, No. 100, Luyun Road 410205 Changsha, China</p>	
<p>(210): 1691693 (151): 25/07/2022 (511): 7, 11, 21 and 35 (732): ÖZTIINOKS MADENI ESYA ENERJİ TARIMSAL GIDA ÜRÜNLERİ SANAYİ VE TİCARET ANONİM ŞİRKETİ of MALTEPE MAH., FAZILPASA ÇIKMAZ SK. 10, Zeytinburnu İstanbul, Turkey</p>	
<p>(210): 1691904 (151): 28/09/2022 (511): 33 (732): Jack Daniel's Properties, Inc. of 4040 Civic Center Drive, Suite 528 San Rafael CA 94903, United States of America</p>	
<p>(210): 1691912 (151): 28/09/2022 (511): 33 (732): Jack Daniel's Properties, Inc. of 4040 Civic Center Drive, Suite 528 San Rafael CA 94903, United States of America</p>	
<p>(210): 1692015 (151): 16/06/2022 (511): 9, 28 and 41 (732): Euro Games Technology Ltd. of "Maritsa" Str. 4, "Vranya-Lozen-Triugulnika" BG-1151 Sofia, Bulgaria</p>	
<p>(210): 1692042 (151): 05/10/2022 (511): 9 and 20 (732): MMD-Monitors & Displays Nederland B.V. of Prins Bernhardplein 200 NL-1097 JB Amsterdam, Netherlands</p>	<p>EVNIA</p>
<p>(210): 1692116 (151): 24/08/2022 (511): 5 (732): Shijiazhuang Yiling Pharmaceutical Co., Ltd. of 238, Tianshan Street, Hi-Tech Area, Shijiazhuang 100022 Hebei Province, China</p>	<p>Coraidloc</p>
<p>(210): 1692132 (151): 29/07/2022 (511): 25 (732): TENDAM RETAIL, S.A. of Avda. Del Llano Castellano, 51 E-28034 Madrid, Spain</p>	<p>HI&BYE</p>
<p>(210): 1692179 (151): 29/07/2022 (511): 36 and 41 (732): SUOL INNOVATIONS LTD of 41 Themistokli Dervi, Hawaii Tower, 1st floor, Office 106 CY-1066 Nicosia, Cyprus</p>	

(210): 1692369 (151): 05/08/2022

(511): 5 and 10

(732): HANGZHOU TONGZHOU BIOTECHNOLOGY CO., LTD. of ROOM 102, 1ST FLOOR, BUILDING 4, NO. 191, XINTIAN ROAD, YUNHE STREET, LINPING DISTRICT, HANGZHOU CITY 310018 ZHEJIANG PROVINCE, China



(210): 1692375 (151): 09/08/2022

(511): 30

(732): FERRERO S.P.A. of PIAZZALE PIETRO FERRERO 1 I-12051 ALBA, CUNEO, Italy



(210): 1692481 (151): 10/10/2022

(511): 33

(732): PROTOS BODEGA RIBERA DUERO DE PEÑAFIEL, S.L. of Calle Bodegas Protos, 24-28 E-47300 Peñafiel (Valladolid), Spain

PROTOS

(210): 1692494 (151): 16/06/2022

(511): 9, 28 and 41

(732): Euro Games Technology Ltd. of "Maritsa" Str. 4, "Vranya-Lozen-Triugulnika" BG-1151 Sofia, Bulgaria



(210): 1692529 (151): 08/08/2022

(511): 7

(732): FENGCHENG PACIFIC SHENLONG TURBOCHARGER CO., LTD of NO. 9 NORTH STREET, D DISTRICT, MODERN INDUSTRIAL PARK, FENGSHAN ADMINISTRATIVE DISTRICT, FENGCHENG CITY 118100 LIAONING PROVINCE, China



(210): 1692584 (151): 05/10/2022

(511): 9 and 20

(732): MMD-Monitors & Displays Nederland B.V. of Prins Bernhardplein 200 NL-1097 JB Amsterdam, Netherlands

EVNIA

(210): 1692587 (151): 28/09/2022

(511): 9, 35, 38, 42, 44 and 45

(732): Curalie GmbH of Leipziger Straße 61A 10117 Berlin, Germany

CURALIE

(210): 1692617 (151): 05/10/2022

(511): 9 and 20

(732): MMD-Monitors & Displays Nederland B.V. of Prins Bernhardplein 200 NL-1097 JB Amsterdam, Netherlands



(210): 1692636 (151): 25/07/2022

(511): 1, 3, 5, 16, 19, 21 and 27

(732): Paebbl AB of Kungsgatan 10 SE-111 43 Stockholm, Sweden

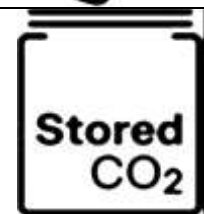

(210): 1692928 (151): 10/08/2022

(511): 20, 24 and 35

(732): YATAS YATAK VE YORGAN SAN.TIC.A.S. of YILDIZEVLER MH SIVAS CD 325 KOCASINAN KAYSERI, Turkey

enza HOME

(210): 1693015 (151): 19/07/2022

(511): 9, 38, 41, 42 and 45

(732): Pulse Africa Holding AG of Brühlstrasse 5 CH-4800 Zofingen, Switzerland



(210): 1693218 (151): 11/07/2022
 (511): 9, 28 and 41
 (732): Euro Games Technology Ltd. of 4, "Maritsa" Str., "Vranya-Lozen-Triugulnika" BG-1151 Sofia, Bulgaria



(210): 1693261 (151): 06/06/2022
 (511): 7
 (732): Asia Fuji Elevator Co., Ltd. of D-02, Middle Section of Shaoyang Avenue, Shuangqing District, Shaoyang City 422002 Hunan Province, China



(210): 1693330 (151): 07/11/2022
 (511): 6, 7, 9, 11, 19, 35, 41 and 42
 (732): The Segen Group Limited of Wesley Hall, Barrack Road Aldershot, Hampshire GU11 3NP, United Kingdom

SEGENSOLAR

(210): 1693331 (151): 07/11/2022
 (511): 6, 7, 9, 11, 19, 35, 41 and 42
 (732): The Segen Group Limited of Wesley Hall, Barrack Road Aldershot, Hampshire GU11 3NP, United Kingdom



(210): 1693444 (151): 13/07/2022
 (511): 7
 (732): Elizabeth Kemp of 831 North Point View Road Oconomowoc WI 53066, United States of America

SHARPSHARK

(210): 1693445 (151): 11/07/2022
 (511): 9, 28 and 41
 (732): Euro Games Technology Ltd. of 4, "Maritsa" Str., "Vranya-Lozen-Triugulnika" BG-1151 Sofia, Bulgaria

Gems' Realm

(210): 1693447 (151): 13/07/2022
 (511): 1
 (732): Biolevel Limited of Bronsens, Hillside, Albion Street CHIPPING NORTON, Oxfordshire OX7 5BH, United Kingdom

BIOLEVEL

(210): 1693464 (151): 25/07/2022
 (511): 9, 39, 42 and 45
 (732): Bosch Sicherheitssysteme GmbH of Robert-Bosch-Platz 1 70839 Gerlingen, Germany

IQsight

(210): 1693965 (151): 29/07/2022
 (511): 29 and 33
 (732): TORRE CIVETTE SOCIETA' AGRICOLA S.R.L. of Via dei Sette Santi 53 I-50131 FIRENZE, Italy

TORRE CIVETTE

(210): 1694125 (151): 12/08/2022
 (511): 9
 (732): Immersive Health Solutions LLC of 1209 Orange Street Wilmington DE 19801, United States of America

REALITY PROCESSOR

(210): 1694224 (151): 04/10/2022
 (511): 9
 (732): Apple Inc. of One Apple Park Way Cupertino CA 95014, United States of America

STAGE MANAGER

(210): 1694235 (151): 20/06/2022
 (511): 9, 16, 35, 38, 39 and 43
 (732): Condor Flugdienst GmbH of An der Gehespitz 50 63263 Neu-Isenburg, Germany

condor

(210): 1694363 (151): 11/07/2022
 (511): 9, 28 and 41
 (732): Euro Games Technology Ltd. of 4, "Maritsa" Str., "Vranya-Lozen-Triugulnika" BG-1151 Sofia, Bulgaria



(210): 1694523 (151): 07/10/2022
 (511): 12
 (732): RENAULT s.a.s. of 122-122 bis avenue du Général Leclerc F-92100 Boulogne-Billancourt, France



(210): 1694577 (151): 10/10/2022
 (511): 33
 (732): Brown-Forman Distillery, Inc. of 2921 Dixie Highway Shively KY 40216, United States of America



(210): 1694731 (151): 13/09/2022
 (511): 9, 16, 25 and 41
 (732): Wellington School 1837 of Wellington School, South Street WELLINGTON, Somerset TA21 8NT, United Kingdom



(210): 1694743 (151): 18/08/2022
 (511): 7
 (732): Guangdong Wagna Power Technology Co., Ltd. of No. 71, Xinming Road, Xinming Village, Leliu Street, Shunde District, Foshan Guangdong, China



(210): 1694801 (151): 11/07/2022
 (511): 9, 28 and 41
 (732): Euro Games Technology Ltd. of 4, "Maritsa" Str., "Vranya-Lozen-Triugulnika" BG-1151 Sofia, Bulgaria



(210): 1694809 (151): 15/08/2022
 (511): 34
 (732): British American Tobacco (Brands) Limited of Globe House, 4 Temple Place London WC2R 2PG, United Kingdom

VELO LABS

(210): 1694810 (151): 15/08/2022
 (511): 34
 (732): British American Tobacco (Brands) Limited of Globe House, 4 Temple Place London WC2R 2PG, United Kingdom

VELO LABS

(210): 1694931 (151): 05/07/2022
 (511): 9, 12, 16, 35, 36, 38, 39, 41, 42, 44 and 45
 (732): FUNDACION BANCARIA CAIXA D'ESTALVIS I PENSIONS DE BARCELONA, "LA CAIXA" of Av. Diagonal, 621-629 E-08028 Barcelona, Spain

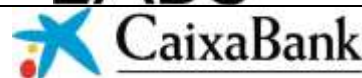

(210): 1694992 (151): 25/07/2022
 (511): 35 and 41
 (732): TÜRKIYE TURİZM TANITIM VE GELİSTİRME AJANSI of Esentepe Mahallesi, Büyükdere Caddesi, Astoria 127 B/71, Sisli Istanbul, Turkey



(210): 1695000 (151): 29/09/2022
 (511): 1 and 5
 (732): FERTIBERIA, S.A. of Calle Agustín de Foxá, 27, Plantas 8-11 E-28036 Madrid, Spain

IMPACT ZERO BY FERTIBERIA

(210): 1695050 (151): 11/07/2022
 (511): 9, 28 and 41
 (732): Euro Games Technology Ltd. of 4, "Maritsa" Str., "Vranya-Lozen-Triugulnika" BG-1151 Sofia, Bulgaria



(210): 1695061 (151): 25/08/2022
 (511): 5, 29 and 30
 (732): MOLINO DI FERRO S.p.A. of Via Molino di Ferro 6 I-31050
 Vedelago (TV), Italy

MOLINO DI FERRO

(210): 1695150 (151): 28/08/2022
 (511): 9, 12, 35, 39 and 42
 (732): Zim Integrated Shipping Services Ltd. of 9 Sakharov Andrei
 St. Haifa, Israel



(210): 1695151 (151): 28/08/2022
 (511): 9, 12, 35, 39 and 42
 (732): Zim Integrated Shipping Services Ltd. of 9 Sakharov Andrei
 St. Haifa, Israel



(210): 1695152 (151): 28/08/2022
 (511): 9, 12, 35, 39 and 42
 (732): Zim Integrated Shipping Services Ltd. of 9 Sakharov Andrei
 St. Haifa, Israel

ZIM

(210): 1695294 (151): 08/07/2022
 (511): 41
 (732): Stropus Ltd. of 7-9 Riga Fereou, Lizantia Court, office 310,
 Agioi Omologites CY-1087 Nicosia, Cyprus



(210): 1695408 (151): 19/08/2022
 (511): 9, 10, 42 and 44
 (732): Immersive Health Solutions LLC of 1209 Orange Street
 Wilmington DE 19801, United States of America

REALITY PRO

(210): 1695413 (151): 22/08/2022
 (511): 34
 (732): Cobev Limited of 39 River Road Barking, Essex IG11 ODA,
 United Kingdom

ZU

(210): 1695505 (151): 11/07/2022
 (511): 9, 28 and 41
 (732): Euro Games Technology Ltd. of 4, "Maritsa" Str., "Vranya-
 Lozen-Triugulnika" BG-1151 Sofia, Bulgaria



(210): 1695792 (151): 16/10/2022
 (511): 35
 (732): Grailed, Inc. of 131 Spring Street, Floor 6 New York NY
 10013, United States of America

GRAILED

(210): 1695828 (151): 17/08/2022
 (511): 9 and 42
 (732): International Business Machines Corporation of New Orchard
 Road Armonk NY 10504, United States of America



INSTANA

(210): 1695829 (151): 17/08/2022
 (511): 9 and 42
 (732): International Business Machines Corporation of New Orchard
 Road Armonk NY 10504, United States of America

IBM INSTANA

(210): 1696031 (151): 17/08/2022
 (511): 35 and 36
 (732): YENI MAGAZACILIK ANONIM SIRKETI of BURHANIYE MAH.
 NAGEHAN SK. 4 B 1 Üsküdar Istanbul, Turkey

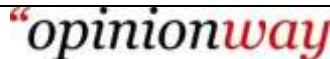

(210): 1696185 (151): 18/07/2022 (511): 9, 35 and 42 (732): International Business Machines Corporation of New Orchard Road Armonk NY 10504, United States of America	WATSON ORDERS
(210): 1696186 (151): 22/07/2022 (511): 9, 16, 35, 41 and 42 (732): International Business Machines Corporation of New Orchard Road Armonk NY 10504, United States of America	MEASURE YOUR CEILING
(210): 1696189 (151): 01/08/2022 (511): 9, 35 and 42 (732): International Business Machines Corporation of New Orchard Road Armonk NY 10504, United States of America	IBM SECURITY REAQT
(210): 1696190 (151): 01/08/2022 (511): 9, 35 and 42 (732): International Business Machines Corporation of New Orchard Road Armonk NY 10504, United States of America	REAQTA
(210): 1696191 (151): 01/08/2022 (511): 9, 35 and 42 (732): International Business Machines Corporation of New Orchard Road Armonk NY 10504, United States of America	IBM SECURITY REAQT AS A SERVICE
(210): 1696206 (151): 11/07/2022 (511): 9, 28 and 41 (732): Euro Games Technology Ltd. of 4, "Maritsa" Str., "Vranya-Lozen-Triugulnika" BG-1151 Sofia, Bulgaria	
(210): 1696267 (151): 19/09/2022 (511): 35 (732): Limited Liability Company "Torgovaya edinita" of Govorova st., 55, Krasnoyarsk RU-660013 Krasnoyarsk region, Russian Federation	
(210): 1696476 (151): 23/08/2022 (511): 5, 29 and 30 (732): MOLINO DI FERRO S.p.A. of Via Molino di Ferro 6 I-31050 Vedelago (TV), Italy	LE ASOLANE
(210): 1696721 (151): 14/07/2022 (511): 9, 38 and 41 (732): Keli Network Inc. of 450 Park Ave. South, 3rd Floor New York NY 10016, United States of America	SUPERMISSION
(210): 1696972 (151): 07/09/2022 (511): 12 (732): BYD COMPANY LIMITED of No. 1, Yan'an Road, Kuichong Street, Dapeng New District 518000 Shenzhen, China	SONG
(210): 1697492 (151): 25/08/2022 (511): 35, 38 and 42 (732): OPINION-WAY of 15 Place de la République F-75003 PARIS, France	
(210): 1697917 (151): 25/08/2022 (511): 35, 38 and 42 (732): OPINION-WAY of 15 Place de la République F-75003 PARIS, France	
(210): 1697930 (151): 25/08/2022 (511): 1, 5 and 31 (732): GREEN IMPULSE of 1 rue Alexandre Fleming F-49000 ANGERS, France	KITAE
(210): 1697974 (151): 13/05/2022 (511): 35, 36, 41 and 42 (732): Trive Investment B.V. of Claude Debussylaan 46 NL-1082 MD Amsterdam, Netherlands	TRIVE

(210): 1698376 (151): 03/08/2022
 (511): 1, 3, 5, 9, 10, 35, 38, 41, 42 and 44
 (732): SANOFI of 54 rue la Boétie F-75008 PARIS, France



(210): 1698405 (151): 28/10/2022
 (511): 9
 (732): Guangzhou BaoLun Electronics Co., Ltd of No. 19, Chuangyuan Road, Zhongcun Street, Panyu District, Guangzhou City Guangdong Province, China



(210): 1698449 (151): 24/10/2022
 (511): 27
 (732): Guangzhou MyWow Decor Co., Ltd. of Room 303, No. 286, Chigangxi Road, Haizhu District, Guangzhou City 510000 Guangdong Province, China



(210): 1698453 (151): 21/10/2022
 (511): 9
 (732): Honor Device Co., Ltd. of Suite 3401, Unit A, Building 6, Shum Yip Sky Park, No. 8089, Hongli West Road, Xiangmihu Street, Futian District, Shenzhen 518040 Guangdong, China

HONOR C1

(210): 1698479 (151): 28/10/2022
 (511): 9
 (732): KUNSHAN HONGJIE ELECTRONICS CO., LTD of 1050 Fu Chun Jiang Road, Economic Development Zone, Kunshan City 215333 Jiangsu Province, China



(210): 1698480 (151): 28/10/2022
 (511): 35
 (732): OPPL LIGHTING CO., LTD. of Rm. 411, Building 1, No. 6111, Longdong Avenue, Pudong New District Shanghai, China

OPPLE

(210): 1698519 (151): 24/10/2022
 (511): 10
 (732): Shanghai Aohua Photoelectricity Endoscope Co., Ltd. of No. 66, Lane 133, Guangzhong Road, Minhang District Shanghai, China

AOHUA

(210): 1698624 (151): 21/09/2022
 (511): 12
 (732): BYD COMPANY LIMITED of No. 1, Yan'an Road, Kuichong Street, Dapeng New District 518000 Shenzhen, China



(210): 1698626 (151): 02/09/2022
 (511): 9
 (732): Guangdong Hua En Audio-video Technology Co., Ltd. of Room 3, 5F Plant 2, V1 District 2, Enping Park, Jiangmen Industrial Transfer Park, Enping City, Jiangmen City Guangdong Province, China

FBW

(210): 1698671 (151): 24/10/2022
 (511): 7 and 11
 (732): Quick Intelligent Equipment Co., Ltd. of No. 11, FengXiang Road, Wujin High-Tech Development Zone, 213161 Changzhou, Jiangsu, China



(210): 1698836 (151): 27/09/2022
 (511): 12
 (732): Qingdao Megalith Tyre Co., Ltd. of 1st floor room 1707, East Office Building, No. 45 Beijing Road, Bonded Port Area, Qingdao 250101 Shandong (Business Secretary Company Trustee Address) (A), China

LEXMONT

(210): 1698837 (151): 20/09/2022
 (511): 9
 (732): Arashi Vision Inc. of Room 1101, 1102, 1103, 11th Floor, Building 2, Jinlitong Financial Center, 1100 Xingye Road, Haiwang Community, Xin'an Street, Bao'an District Shenzhen, China

Insta360

(210): 1698952 (151): 28/06/2022
 (511): 9, 16, 35, 36, 41 and 42
 (732): Willis Group Limited of 51 Lime Street London EC3M 7DQ, United Kingdom

wtw

(210): 1698954 (151): 02/11/2022
 (511): 7 and 9
 (732): Shenzhen FreeYond Technology Co., Ltd. of Unit 203, 2F, Block A, Tengfei Industrial Building, No. 6 Taohua Road, Fubao Community, Fubao Street Futian District, Shenzhen Guangdong, China

FreeYond

(210): 1699067 (151): 30/08/2022
 (511): 29, 30, 31, 32, 35 and 43
 (732): BONDUELLE of La Woestyne F-59173 Renescure, France

Bonduelle

(210): 1699107 (151): 28/10/2022
 (511): 10
 (732): JAFRON BIOMEDICAL CO., LTD. of No. 98 Technology Six Road, High-tech-zone, Zhuhai City 519080 Guangdong, China



(210): 1699109 (151): 28/10/2022
 (511): 10
 (732): JAFRON BIOMEDICAL CO., LTD. of No. 98 Technology Six Road, High-tech-zone, Zhuhai City 519080 Guangdong, China

Jafron

(210): 1699139 (151): 22/03/2022
 (511): 4, 7, 9, 11, 12, 37, 38, 40, 41 and 42
 (732): Koncar - elektroindustrija d.d. of Fallerovo šetalište 22 HR-10000 Zagreb, Croatia

KONCAR

(210): 1699140 (151): 22/03/2022
 (511): 4, 7, 9, 11, 12, 37, 38, 40, 41 and 42
 (732): Koncar - elektroindustrija d.d. of Fallerovo šetalište 22 HR-10000 Zagreb, Croatia

Koncar

(210): 1699265 (151): 29/07/2022
 (511): 35 and 36
 (732): CORE Community Organized Relief Effort of 6464 W. Sunset Blvd., Suite 530 Los Angeles CA 90028, United States of America

CORE

(210): 1699456 (151): 21/10/2022
 (511): 29
 (732): Adascan Grain Corporation of 203- 9555 Yonge St. Richmond Hill ON L4C 9M5, Canada

ADASCAN GRAIN

(210): 1699638 (151): 06/09/2022
 (511): 5, 7, 9 and 42
 (732): Jiangsu Automation Research Institute of No. 18, Shenghu Road, Lianyungang City Jiangsu Province, China



(210): 1699655 (151): 02/09/2022
 (511): 9, 28 and 41
 (732): Euro Games Technology Ltd. of "Maritsa" Str. 4, "Vranya-Lozen-Triugulnika" BG-1151 Sofia, Bulgaria

Shining Hot

(210): 1699658 (151): 21/07/2022
 (511): 7 and 9
 (732): WENLING AWT MACHINERY CO., LTD. of East of Xincheng Avenue, Qiaowu Village, Zeguo Town, Wenling, Taizhou City 317523 Zhejiang Province, China

Azzuno

(210): 1699685 (151): 29/07/2022
 (511): 9, 28 and 41
 (732): Euro Games Technology Ltd. of "Maritsa" Str. 4, "Vranya-Lozen-Triugulnika" BG-1151 Sofia, Bulgaria

40 Super Flaming

(210): 1699724 (151): 25/07/2022
 (511): 9, 28 and 41
 (732): Euro Games Technology Ltd. of 4, "Maritsa" Str., "Vranya-Lozen-Triugulnika" BG-1151 Sofia, Bulgaria



(210): 1699777 (151): 23/09/2022
 (511): 34
 (732): Dongguan Hanhui Jingbo Technology Co., Ltd of Room 201, Building 2, No. 12, Huaifu Road, Chang'an Town, Dongguan City 523000 Guangdong Province, China



(210): 1699783 (151): 21/09/2022
 (511): 3, 6, 9, 20, 21, 27, 35, 36 and 39
 (732): Holcim AG of Grafenauweg 10 CH-6300 Zug, Switzerland

ELEVATE

(210): 1699833 (151): 25/08/2022
 (511): 23, 24 and 26
 (732): NINGBO MH INDUSTRY CO., LTD. of Room 611, Building 5, No. 22, Henghe Road, Beilun, Ningbo Zhejiang, China



KROWNTX

(210): 1699835 (151): 07/09/2022
 (511): 35 and 36
 (732): Bank of America Corporation of 100 North Tryon Street Charlotte NC 28255, United States of America

BANK OF AMERICA BREAKTHROUGH LAB

(210): 1699878 (151): 29/07/2022
 (511): 9, 28 and 41
 (732): Euro Games Technology Ltd. of 4, "Maritsa" Str., "Vranya-Lozen-Triugulnika" BG-1151 Sofia, Bulgaria



(210): 1699891 (151): 31/10/2022
 (511): 24, 25 and 28
 (732): Arnold Fehn of Bergstraße 20k 96450 Coburg, Germany



(210): 1699894 (151): 13/05/2022
 (511): 1, 3, 4, 5, 6, 7, 8, 9, 10, 11, 12, 14, 15, 16, 18, 20, 21, 24, 25, 26, 27, 28, 29, 30, 31, 32, 33, 34, 35, 36, 37, 38, 39, 40, 41, 42, 43 and 45
 (732): Fédération Internationale de Football Association (FIFA) of FIFA-Strasse 20 CH-8044 Zürich, Switzerland



La'eeb

(210): 1699934 (151): 19/09/2022
 (511): 33
 (732): ROYAL-VOSTOK INVESTMENTS LIMITED of Arch. Makariou III, 206 Chrysalia Court, 5th floor CY-3030 Limassol, Cyprus



(210): 1699988 (151): 01/07/2022
 (511): 1, 3, 5, 9, 10, 35, 38, 41, 42 and 44
 (732): SANOFI of 54 rue la Boétie F-75008 PARIS, France



(210): 1700054 (151): 17/05/2022
 (511): 7, 12 and 35
 (732): SRP SADID OTOMOTIV ANONIM SIRKETI of Selimpasa Mah.
 5003 Sok. No:15 TR-34490 Silivri ISTANBUL, Turkey



(210): 1700058 (151): 21/10/2022
 (511): 34
 (732): IPG INK INC of 5900 BALCONES DRIVE STE 100 AUSTIN TX
 78731, United States of America



(210): 1700081 (151): 18/08/2022
 (511): 9
 (732): UNITED MS ELECTRICAL MFG. (M) SDN BHD. of Lot 48, Jalan
 Industri 2/1, Rawang Integrated Industrial Park 48000 Rawang
 Selangor, Malaysia



(210): 1700157 (151): 08/07/2022
 (511): 39, 41, 42 and 45
 (732): Lucella Limited of Spyrou Kyprianou 20, Chapo Central, 3rd
 floor CY-1075 Nicosia, Cyprus



(210): 1700262 (151): 14/11/2022
 (511): 7 and 11
 (732): Yiwu Choucheng Laoguang Electric Appliances Firm of Shop
 F3-17111, International Trade City, China Commodity City, Yiwu,
 Jinhua City Zhejiang Province, China



(210): 1700365 (151): 10/11/2022
 (511): 28
 (732): HYUNDAI MOTOR COMPANY of 12, Heolleung-ro, Seocho-gu
 Seoul 06797, Republic of Korea



(210): 1700429 (151): 29/07/2022
 (511): 9, 28 and 41
 (732): Euro Games Technology Ltd. of 4, "Maritsa" Str., "Vranya-
 Lozen-Triugulnika" BG-1151 Sofia, Bulgaria

Mighty God of the Seas

(210): 1700604 (151): 14/07/2022
 (511): 3
 (732): RANDY SAPUTRA of APT. CITY RESORT TOWER ORCHID LT.
 15A/1, CENGKARENG TIMUR, Kota Administrasi Jakarta Barat DKI
 Jakarta 11730, Indonesia



(210): 1700755 (151): 14/07/2022
 (511): 5
 (732): RANDY SAPUTRA of APT. CITY RESORT TOWER ORCHID LT.
 15A/1, CENGKARENG TIMUR, Kota Administrasi Jakarta Barat DKI
 Jakarta 11730, Indonesia



(210): 1700835 (151): 31/08/2022
 (511): 12
 (732): GUANGDONG MANCANDO INFORMATION TECHNOLOGY CO.,
 LTD. of Floor 22 (Whole Floor), Vanke Sanyuanli Center, No. 31,
 Airport Road, Baiyun District, Guangzhou City 510080 Guangdong
 Province, China



(210): 1700943 (151): 10/03/2022
 (511): 3 and 5
 (732): LOUNA SARL of Rue des Eaux Vives 94 CH-1207 Genève,
 Switzerland

INNOVYAL

(210): 1700949 (151): 19/09/2022
 (511): 9
 (732): Kia Corporation of 12, Heolleung-ro, Seocho-gu Seoul 06797,
 Republic of Korea

Kia

(210): 1700957 (151): 11/11/2022
 (511): 5
 (732): Access Bio, Inc. of 65 Clyde Rd., Ste A Somerset NJ 08873,
 United States of America

CARESUPERB

(210): 1700972 (151): 15/09/2022
 (511): 34
 (732): Shenzhen Han Qing Da Technology Co., Ltd. of Rm. 203,
 207&12/F, Bldg. 1, Hi-Tech Park, Guangqiao Rd., Tianliao
 Community, Yutang St., Guangming Dist., Shenzhen 518107
 Guangdong, China

HQD

(210): 1700998 (151): 08/11/2022
 (511): 35 and 44
 (732): Hear.com N.V. of Amsterdamsestraatweg 421 NL-3551 CL
 Utrecht, Netherlands



(210): 1701029 (151): 03/11/2022
 (511): 12
 (732): ŠKODA AUTO a.s. of Tr. Václava Klementa 869, Mladá
 Boleslav II CZ-293 01 Mladá Boleslav, Czech Republic



(210): 1701034 (151): 03/11/2022
 (511): 12
 (732): ŠKODA AUTO a.s. of Tr. Václava Klementa 869, Mladá
 Boleslav II CZ-293 01 Mladá Boleslav, Czech Republic

SKODA

(210): 1701049 (151): 18/08/2022
 (511): 9, 35 and 38
 (732): AIRGSM PTE. LTD. of 79 ANSON ROAD, #23-01 SINGAPORE
 079906, Singapore



(210): 1701054 (151): 02/11/2022
 (511): 14
 (732): Montres Tudor SA of Rue François-Dussaud 3 CH-1211 Genève
 26, Switzerland

BLACK BAY 54

(210): 1701116 (151): 17/08/2022
 (511): 1
 (732): Guangdong Pustar Adhesives & Sealants Co., Ltd. of Room
 102, No. 256 Qingxidongfeng Rd., Qingxi Town, Dongguan
 Guangdong Province, China



(210): 1701131 (151): 07/11/2022
 (511): 5
 (732): Marizyme, Inc. of Ste. 205, 555 Heritage Drive Jupiter FL
 33458, United States of America

CYTOPRO

(210): 1701172 (151): 29/07/2022
 (511): 9, 28 and 41
 (732): Euro Games Technology Ltd. of 4, "Maritsa" Str., "Vranya-
 Lozen-Triugulnika" BG-1151 Sofia, Bulgaria

EL PISTOLERO

(210): 1701192 (151): 28/10/2022
 (511): 9 and 42
 (732): AFL TELECOMMUNICATIONS LLC of 170 Ridgeview Center Drive Duncan SC 29334, United States of America

FLEXREPORTS

(210): 1701216 (151): 07/07/2022
 (511): 35, 41 and 44
 (732): Koninklijke Douwe Egberts B.V. of Oosterdoksstraat 80 NL-1011 DK Amsterdam, Netherlands

COMMON GROUNDS

(210): 1701262 (151): 25/07/2022
 (511): 9, 28 and 41
 (732): Euro Games Technology Ltd. of 4, "Maritsa" Str. "Vranya-Lozen-Triugulnika" BG-1151 Sofia, Bulgaria

**UNITED DREAMS 3
MULTIGAME**

(210): 1701266 (151): 23/09/2022
 (511): 9, 28 and 41
 (732): Euro Games Technology Ltd. of "Maritsa" Str. 4, "Vranya-Lozen-Triugulnika" BG-1151 Sofia, Bulgaria

EGYPTIAN TALE

(210): 1701289 (151): 25/07/2022
 (511): 9, 28 and 41
 (732): Euro Games Technology Ltd. of 4, "Maritsa" Str. "Vranya-Lozen-Triugulnika" BG-1151 Sofia, Bulgaria

40 Super Flame

(210): 1701326 (151): 15/11/2022
 (511): 34
 (732): Jitusmi Imports Inc. of 214 E. Lynn Street Seattle WA 98102, United States of America

elftank

(210): 1701388 (151): 10/11/2022
 (511): 42
 (732): Apple Inc. of One Apple Park Way Cupertino CA 95014, United States of America

LIVE ACTIVITIES

(210): 1701463 (151): 21/07/2022
 (511): 9
 (732): NIKON CORPORATION of 2-15-3, Konan, Minato-ku Tokyo 108-6290, Japan

Nikon Lenswear

(210): 1701520 (151): 15/11/2022
 (511): 25
 (732): FLO MAGAZACILIK VE PAZARLAMA ANONIM SIRKETI of MAHMUTBEY MAH. TASOCAGI YOLU CAD. 24 31 Bagcilar Istanbul, Turkey

PROSHOT

(210): 1701630 (151): 10/11/2022
 (511): 9
 (732): Apple Inc. of One Apple Park Way Cupertino CA 95014, United States of America

LIVE ACTIVITIES

(210): 1701674 (151): 15/11/2022
 (511): 9, 11 and 35
 (732): Guangzhou BaoLun Electronics Co., Ltd. of No. 19, Chuangyuan Road, Zhongcun Street, Panyu District, Guangzhou 510000 Guangdong, China

itCAVL

(210): 1701801 (151): 29/06/2022
 (511): 10, 37 and 41
 (732): Gradian Health Systems, Inc. of 40 West 25th Street, 6th Floor New York NY 10010, United States of America

**GRADIAN HEALTH
SYSTEMS**

(210): 1701823 (151): 25/07/2022
 (511): 9, 28 and 41
 (732): Euro Games Technology Ltd. of 4, "Maritsa" Str. "Vranya-Lozen-Triugulnika" BG-1151 Sofia, Bulgaria

**BONUS PRIZE
GENERAL**

(210): 1701921 (151): 11/04/2022
 (511): 35, 36 and 41
 (732): Square, Inc. of Suite 600, 1455 Market Street San Francisco CA 94103, United States of America

Cash App Studios

(210): 1701946 (151): 05/11/2022

(511): 9

(732): Apple Inc. of One Apple Park Way Cupertino CA 95014,
United States of America

FREEFORM

(210): 1701976 (151): 29/07/2022

(511): 9, 28 and 41

(732): Euro Games Technology Ltd. of 4, "Maritsa" Str., "Vranya-
Lozen-Triugulnika" BG-1151 Sofia, Bulgaria

20 Super 7 Flame

(210): 1702071 (151): 17/03/2022

(511): 1, 7, 9, 12, 17, 35, 37, 39 and 42

(732): KYB Corporation of 4-1, Hamamatsu-cho 2-chome, Minato-ku
Tokyo 105-5128, Japan

KAYABA

(210): 1702075 (151): 11/03/2022

(511): 6, 7, 9, 12, 19, 20, 37, 39, 41 and 42

(732): Innova Patent GmbH of Konrad-Doppelmayr-Straße 1 A-6922
Wolfsfurt, Austria

doppelmayr

(210): 1702121 (151): 20/06/2022

(511): 9 and 42

(732): Sage Global Services Limited of C23 - 5 & 6 Cobalt Park Way,
Cobalt Park Newcastle Upon Tyne NE28 9EJ, United Kingdom

SAGE INTACCT

(210): 1702152 (151): 15/07/2022

(511): 7, 9, 17, 35 and 42

(732): Shenzhen Anycubic Technology Co., Ltd. of 1201-1314, Office
Building 3B, Vanke Times Square, No.85 Longcheng Avenue,
Shangjing Community, Longcheng Street Longgang District,
Shenzhen 518000 Guangdong, China



(210): 1702157 (151): 15/08/2022

(511): 7, 8 and 9

(732): Hunan Tuofurui Tools Co., Ltd.; TOP FORZA ELECTRONICS
TECHNOLOGY CO., LTD. of Room 601, Block 18, Polymerization
Industrial Park, No. 519 Zhenhua Road, Yuhua District, Changsha
City Hunan Province, China; No. 13, Ln. 362, Sec. 2, Ganyuan St.,
Shulin Dist., New Taipei City 23853 Taiwan Province, China

TOPFORZA

(210): 1702257 (151): 27/10/2022

(511): 35

(732): Enagic Europe GmbH of Immermannstr. 33 40210 Düsseldorf,
Germany

**Change Your Water
Change Your Life**

(210): 1702262 (151): 27/10/2022

(511): 35

(732): Enagic Europe GmbH of Immermannstr. 33 40210 Düsseldorf,
Germany

Enagic

(210): 1702263 (151): 27/10/2022

(511): 35

(732): Enagic Europe GmbH of Immermannstr. 33 40210 Düsseldorf,
Germany

Kangen Water

(210): 1702309 (151): 10/11/2022

(511): 35 and 41

(732): Microverse Enterprises, Inc. of 2443 Fillmore St., #380-14158
San Francisco CA 94115, United States of America

MICROVERSE

(210): 1702419 (151): 18/07/2022

(511): 9 and 11

(732): EcoFlow Inc. of Plant A202, Founder Technology Industrial
Park, Shiyan Sub-district, Bao'an District, Shenzhen 518100
Guangdong, China

ECOFLOW

(210): 1702430 (151): 26/10/2022

(511): 39

(732): PORTLINE BULK INTERNATIONAL S.A. of AVENIDA INFANTE
DOM HENRIQUE, N° 332, 3° P-1849-025 LISBOA, Portugal



(210): 1702466 (151): 09/11/2022
 (511): 10
 (732): HYUNDAI MOTOR COMPANY of 12, Heolleung-ro, Seocho-gu
 Seoul 06797, Republic of Korea



(210): 1702558 (151): 27/10/2022
 (511): 42 and 43
 (732): SUSHI JIRO IP PTY LTD of Level 7, SE 1 520 Collins St
 Melbourne VIC 3000, Australia

Sushi Jiro

(210): 1702665 (151): 29/08/2022
 (511): 3, 5 and 35
 (732): Brand For Pharmaceutical Industries of 5th floor, flat no 22,
 64 ELTahrir St, Dokki Giza, Egypt



(210): 1702694 (151): 09/08/2022
 (511): 19 and 20
 (732): FINANCIERA MADERERA, S.A. of Formaris, s/n, Santiago de
 Compostela E-15707 A Coruña, Spain



(210): 1702706 (151): 11/08/2022
 (511): 23
 (732): International For Spining Interyarn of Piece No 7- Block 14,
 4th Industrial Zone, New Borg El Arab Alexandria, Egypt



(210): 1702822 (151): 09/08/2022
 (511): 30
 (732): FERRERO S.P.A. of PIAZZALE PIETRO FERRERO 1 I-12051
 ALBA, CUNEO, Italy



(210): 1702827 (151): 01/11/2022
 (511): 33
 (732): Jack Daniel's Properties, Inc. of 4040 Civic Center Drive,
 Suite 528 San Rafael CA 94903, United States of America

JD

(210): 1702911 (151): 20/01/2022
 (511): 9, 28 and 41
 (732): MS Partners Ltd. of 73, Patriarh Evtimii Blvd., floor 1 BG-
 1463 Sofia, Bulgaria

Burning Wheels

(210): 1702914 (151): 15/03/2022
 (511): 9, 25, 41 and 42
 (732): Larva Labs, LLC of 246 Fifth Avenue, Floor 3 New York NJ
 10001, United States of America

Meebits

(210): 1702915 (151): 15/03/2022
 (511): 9, 25, 41 and 42
 (732): Larva Labs, LLC of 246 Fifth Avenue, Floor 3 New York NJ
 10001, United States of America

CryptoPunks

(210): 1702931 (151): 20/04/2022
 (511): 19
 (732): United Construction Products, LLC of 701 OSAGE STREET
 BLDG 2, UNIT 120 Denver CO 80204, United States of America

BISON SCREWJACK

(210): 1702945 (151): 02/05/2022
 (511): 9, 16, 35, 36, 37, 38, 41 and 42
 (732): HP Hewlett Packard Group LLC of 10300 Energy Drive Spring
 TX 77389, United States of America

**HEWLETT PACKARD
 ENTERPRISE**

(210): 1703000 (151): 14/07/2022
 (511): 9, 28, 37, 38, 41 and 42
 (732): Euro Games Technology Ltd. of 4, "Maritsa" Str., "Vranya-Lozen-Triugulnika" BG-1151 Sofia, Bulgaria



(210): 1703039 (151): 24/10/2022
 (511): 7, 9, 11, 37 and 39
 (732): ENERGY DOME S.p.A. of VIALE ABRUZZI 94 I-20131 MILANO (MI), Italy

ENERGY DOME

(210): 1703074 (151): 30/08/2022
 (511): 45
 (732): Corporation de Sécurité Garda World / Garda World Security Corporation of 1390 rue Barré Montréal QC H3C 1N4, Canada

GARDAWORLD

(210): 1703171 (151): 26/09/2022
 (511): 35, 39, 40 and 42
 (732): Sociedade Nacional De Combustiveis De Angola of Rua Rainha Ginga N° 29/31 Luanda, Angola

SONANGOL

(210): 1703221 (151): 26/10/2022
 (511): 39
 (732): PORTLINE OCEAN MANAGEMENT S.A. of AVENIDA INFANTE DOM HENRIQUE P-1849-025 N° 332, 3.º, Portugal



(210): 1703443 (151): 28/06/2022
 (511): 9 and 42
 (732): xFusion Digital Technologies Co., Limited of 9th Floor, Building 1, Zensun Boya Square, Longzihu Wisdom Island, Zhengdong New District, Zhengzhou 450000 Henan Province, China

(210): 1703460 (151): 26/07/2022
 (511): 7, 11, 21 and 35
 (732): ÖZTIRYAKILER MADENI ESYA SANAYI VE TICARET ANONIM SIRKETI of CUMHURİYET MAH. ESKİ HADIMKÖY YOLU CAD. 8 1 Büyükçekmece Istanbul, Turkey



(210): 1703545 (151): 09/11/2022
 (511): 39
 (732): HYUNDAI MOTOR COMPANY of 12, Heolleung-ro, Seocho-gu Seoul 06797, Republic of Korea



(210): 1703562 (151): 14/07/2022
 (511): 9, 28, 37, 38, 41 and 42
 (732): Euro Games Technology Ltd. of 4, "Maritsa" Str., "Vranya-Lozen-Triugulnika" BG-1151 Sofia, Bulgaria



(210): 1703563 (151): 14/07/2022
 (511): 9, 28, 37, 38, 41 and 42
 (732): Euro Games Technology Ltd. of 4, "Maritsa" Str., "Vranya-Lozen-Triugulnika" BG-1151 Sofia, Bulgaria



(210): 1703565 (151): 09/08/2022
 (511): 9, 35 and 42
 (732): Mahindra and Mahindra Limited of gateway building, apollo bunder mumbai 400 001, India

mahindra^{Rise}

(210): 1703599 (151): 07/01/2022
 (511): 9, 36, 41 and 42
 (732): TRADEZERO USA INC. of 5700 LAKE WORTH RD, UNIT 209-2 Lake Worth FL 33463, United States of America



(210): 1703601 (151): 06/01/2022
 (511): 1, 5, 29, 30 and 31
 (732): Co2i Limited of 42 Churchway, Haddenham AYLESBURY,
 Buckinghamshire HP17 8HE, United Kingdom

DRYGRO

(210): 1703660 (151): 14/07/2022
 (511): 9, 28, 37, 38, 41 and 42
 (732): Euro Games Technology Ltd. of 4, "Maritsa" Str., "Vranya-
 Lozen-Triugulnika" BG-1151 Sofia, Bulgaria



(210): 1703665 (151): 20/07/2022
 (511): 9
 (732): Eintracht Frankfurt e.V. of Gustav-Behringer-Str. 10 60386
 Frankfurt am Main, Germany



(210): 1703768 (151): 28/10/2022
 (511): 9, 14, 18 and 25
 (732): Guess?, Inc. of 1444 South Alameda Street Los Angeles CA
 90021, United States of America

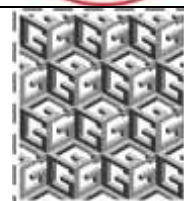

(210): 1703780 (151): 25/10/2022
 (511): 9, 36, 42 and 44
 (732): Downforce Technologies Limited of 2 Littlegate Street
 Oxford OX1 1QT, United Kingdom

**DOWNFORCE CARBON
UNIT**

(210): 1704051 (151): 31/10/2022
 (511): 33
 (732): Société Jas Hennessy & Co. of Rue de la Richonne F-16100
 Cognac, France



(210): 1704172 (151): 27/05/2022
 (511): 3
 (732): BLACKROSE KOZMETIK IHRACAT ITHALAT TICARET LIMITED
 SIRKETI of ORHAN GAZI MAH. 1715. SK. 19 Esenyurt Istanbul, Turkey

**NISHAPUR
PERFUME**

(210): 1704179 (151): 19/08/2022
 (511): 5
 (732): CANSINO BIOLOGICS INC. of 401-420, 4/F, Biomedical Park of
 West Zone, 185 South Avenue, TEDA West District Tianjin, China

(210): 1704196 (151): 14/11/2022
 (511): 28
 (732): HYUNDAI MOTOR COMPANY of 12, Heolleung-ro, Seocho-gu
 Seoul 06797, Republic of Korea

HYUNDAI

(210): 1704199 (151): 16/11/2022
 (511): 37
 (732): HYUNDAI MOTOR COMPANY of 12, Heolleung-ro, Seocho-gu
 Seoul 06797, Republic of Korea



(210): 1704215 (151): 31/10/2022
 (511): 33
 (732): Société Jas Hennessy & Co. of Rue de la Richonne F-16100
 Cognac, France



(210): 1704249 (151): 16/09/2022
 (511): 5 and 10
 (732): SANSURE BIOTECH FRANCE of 66 avenue des Champs-Élysées
 F-75008 PARIS, France

TSure

(210): 1704407 (151): 28/04/2022
 (511): 2, 4, 5, 7, 12, 15, 34, 40 and 44
 (732): TIKTOK INFORMATION TECHNOLOGIES UK LIMITED of 6TH FLOOR, ONE LONDON WALL LONDON EC2Y 5EB, United Kingdom



(210): 1704413 (151): 01/09/2022
 (511): 9, 16, 35, 36, 41 and 45
 (732): Voluntary Service Overseas of 100 London Road Kingston Upon Thames KT2 6QJ, United Kingdom



(210): 1704462 (151): 19/07/2022
 (511): 35, 36 and 41
 (732): Movement 4 Black Lives, Inc. of 1624 Franklin Street, #1022 Oakland CA 94612, United States of America

**THE MOVEMENT FOR
BLACK LIVES**

(210): 1704464 (151): 19/07/2022
 (511): 35, 36 and 41
 (732): Movement 4 Black Lives, Inc. of 1624 Franklin Street, #1022 Oakland CA 94612, United States of America

M4BL

(210): 1704524 (151): 24/10/2022
 (511): 7, 9, 11, 37 and 39
 (732): ENERGY DOME S.p.A. of VIALE ABRUZZI 94 I-20131 MILANO (MI), Italy

CO2 BATTERY

(210): 1704547 (151): 09/11/2022
 (511): 10
 (732): HYUNDAI MOTOR COMPANY of 12, Heolleung-ro, Seocho-gu Seoul 06797, Republic of Korea



(210): 1704812 (151): 14/07/2022
 (511): 9, 28, 37, 38, 41 and 42
 (732): Euro Games Technology Ltd. of 4, "Maritsa" Str., "Vranya-Lozen-Triugulnika" BG-1151 Sofia, Bulgaria



(210): 1704941 (151): 25/05/2022
 (511): 9, 12, 25 and 28
 (732): AUTOMOBILI LAMBORGHINI SPA of Via Modena 12 I-40019 Sant'Agata Bolognese (BO), Italy

REVUELTO

(210): 1705062 (151): 16/11/2022
 (511): 28
 (732): HYUNDAI MOTOR COMPANY of 12, Heolleung-ro, Seocho-gu Seoul 06797, Republic of Korea



(210): 1705304 (151): 08/08/2022
 (511): 36 and 42
 (732): SCV Research & Development Pte Ltd of 80 ROBINSON ROAD, #02-11 SINGAPORE 068898, Singapore

TASConnect

(210): 1705368 (151): 22/09/2022
 (511): 39 and 45
 (732): Corporation de Sécurité Garda World / Garda World Security Corporation of 1390 rue Barré Montréal QC H3C 1N4, Canada

GARDA

11.7 Corrigenda

(111) Mark number: 821615
 (540) Trademark: BELT
 (511) Classes: 1 & 5
 (442) Date of notification: 15th April, 2004

(580) Correction:

The application was erroneously included in the Journal of February 2023

12.0 General Information

1. Patent, Utility Models and Industrial Design fees.

The following is a list of various fees payable under the Industrial Property Regulations, 2002

Patents

	Local (Kshs)	Foreign USD
Filing fee (full specification)	3, 000	150
Provisional application filing fee	1, 000	50
Substantive examination request	5, 000	250
Publication fee	3, 000	150
Grant fee	3, 000	150
Annual renewal fee -2 nd year - (varies according to years)	2, 000	300

Utility Models

	Local (Kshs)	Foreign USD
Filing fee (full specification)	1, 000	50
Provisional application filing fee	500	50
Publication fee	3, 000	150
Registration fee	3, 000	150
Annual renewal fee -2 nd year - (varies according to years)	1, 000	50

Industrial Designs

	Local (Kshs)	Foreign USD
Filing fee	3, 000	150
Publication fee	3, 000	150
Registration fee	1, 000	50
Renewal fee (after five years from application date)	10, 000	500

The complete list of fees is available on the Institute website: www.kipi.go.ke.

2. African Regional Intellectual Property Organization (ARIPO)

ARIPO is a regional body established by African governments to have a central office to among other things, process and grant industrial property rights on behalf of member states. ARIPO grants patents, utility models and industrial designs on behalf of Kenya. Currently, ARIPO consists of the following 16 member states; Botswana, Gambia, Ghana, Kenya, Lesotho, Liberia, Malawi, Mozambique, Namibia Sierra Leone, Sudan, Swaziland, Tanzania, Uganda, Zambia and Zimbabwe. Kenyan applicants are required by law to first file with the Institute before filing with ARIPO. ARIPO secretariat is located in Harare Zimbabwe.

The complete fee schedule for ARIPO is available on their website <http://www.aripo.org>. The following are the fees an applicant is required to pay immediately on application.

	Patents	Utility Models	Industrial Designs
Filing fee	USD 250	USD 100	USD 50
Designation fee (multiply with no. of designated countries)	USD 75	USD 20	USD 10
Transmission fee	Kshs 5000	Kshs 5000	Kshs 5000

3. Patent Cooperation Treaty

The Patent Cooperation Treaty (PCT) is an international patent protection treaty consisting of over 140 member states. PCT is administered by the World Intellectual Property Organization in Geneva Switzerland. PCT makes it possible for an applicant to seek patent protection for an invention simultaneously in any of the selected member states by filing one application. PCT is a filing system and does not grant patents on behalf of the member states. Applications must enter national phase in the selected member states. In the national phase, the applicant is required to pay the prescribed national fees in the said member states. Further, in

some member states, a foreign applicant is required to have a resident agent. The PCT fees as of 1st May 2011 are as follows:

Type of fee	Fee		Fee waivers
International filing fee	USD 1, 367 or CHF 1330		90% waiver for a natural person from Kenya
Search fees (only one search authority needs to be selected by applicant)	Austria	USD 2, 443	75% waiver for natural a person from Kenya
	Australia	USD 1, 837	None
	China	USD 314	None
	European Patent office	USD 2, 443	75% waiver for a natural person from Kenya
	Sweden	USD 2, 443	None
Transmittal fee	Kshs 5000		-

More information is available on the PCT website www.wipo.int/pct/en

4. Kenya is a signatory to the following Treaties related to industrial property rights:

No.	Treaty	Year of accession/ratification
1.	The Lusaka Agreement, establishing the African Regional Intellectual Property Organization	15 th February 1978
2.	The Protocol on Patents and Industrial Designs (Harare Protocol)	24 th October 1984
3.	The Paris Convention for Protection of Industrial Property	14 th June, 1965
4.	The World Intellectual Property Organization Convention	5 th October 1971
5.	Nairobi Treaty on the Protection of the Olympic Symbol	25 th September 1982
6.	The Patent Cooperation Treaty	8 th June 1994
7.	The Madrid Agreement Concerning the International Registration of Marks	26 th June 1998
8.	The Protocol Relating to the Madrid Agreement Concerning the International Registration of Marks	26 th June 1998
9.	The Trade Related Aspects of Intellectual Property Rights Agreement	1 st January 1995

5. Trade Marks Forms and Fees

The following are some of the prescribed forms and the respective fees under the Trade Marks Rules:

	Description of fee	Local Fee Kshs	Foreign Fee US\$	Corresponding form
1.	Application fee for an application to register a trade mark: for the first class for each subsequent class	4, 000 3,000	200 150	TM 2
2.	Fee for registration of a trade mark under r. 60(1): for the first class for each subsequent class	2, 000 1, 500	150 100	-

3.	Fee for filing a notice of opposition to an application to register a trade mark: for the first class for each subsequent class	5000 4000	250 200	TM 6
4.	Fee for filing a counter statement: for the first class for each subsequent class	4, 000 3, 000	200 150	TM 7
5.	Fee for renewal of a registration of a trade mark under r.64(1), 67 or 68 for the first class for each subsequent class	4, 000 3, 000	200 150	TM 10
6.	Application fee for an application, under r. 71, to register an assignment or transmission, for each trade mark assigned or transmitted: for the first class for each subsequent class	3, 000 2,000	150 100	TM 14
7	Application fee for an application, under r. 95, to register a person as a registered user of a registered trade mark, for each trade mark: for the first class for each subsequent class	6, 000 5,000	300 250	TM 48
8.	Application fee for an application, under r. 81(1), 85(2) or 101(2), to alter the trade or business address of the proprietor or a registered user, for each trade mark: for the first class for each subsequent class	2, 000 1, 000	100 50	TM 17
9.	Application fee for an application, under r. 82(1) and section 29, 30, 35 or 36 of the Act, for the making, expunging or varying of an entry in the register, for each trade mark: for the first class for each subsequent class	6, 000 5, 000	300 250	TM 25
10.	Application fee for an application, under r. 85(2) or 101(2), to make a correction to the Register for which a fee is not otherwise specified, for each trade mark: for the first class for each subsequent class	2, 000 1, 000	150 50	TM 19
11.	Application fee for an application, under r. 85(2) or 101(2), to change the name or description of the proprietor or a registered user: for the first class for each subsequent class	3, 000 500	150 50	TM 20
12.	Fee for appointing an agent, under r. 14(2), to act in a proceeding or matter before or affecting the Registrar	1, 000	50	TM 1
13.	Application fee for an application, under r. 102, for an extension of time, other than an extension of time prescribed by rule 76: a. extension not exceeding 30 days	1, 000	50	TM 53

	b. extension exceeding 30 days but not exceeding 60 days	2, 000	100	
	c. extension exceeding 60 days	3, 000	150	
14.	Application fee for an application, under r. 108, to amend a document or drawing or other representation, for each trademark: for the first class for each subsequent class	2, 000 1, 000	100 50	TM 19
15.	Fee for preliminary advice of the Registrar under r. 20(1): for the first class for each subsequent class	3, 000 2, 000	150 50	TM 27

Notes:

1. A foreign fee is payable if the person paying the fee or on whose behalf the fee is being paid does not reside in Kenya and does not have a principal place of business in Kenya.
2. All the prescribed forms and the respective fees payable for matters under the Trade Marks Act and Rules are available at www.kipi.go.ke

6. The International Classification of Goods and Services for the Purposes of the Registration of Marks (Nice Classification)

The Nice Classification is established under the Nice Agreement Concerning the International Classification of Goods and Services for the Purposes of the Registration of Marks, one of the treaties administered by the World Intellectual Property Organization. The Nice Classification was established by an Agreement concluded at a Diplomatic Conference held in Nice on 15th June 1957. Kenya has not ratified the Agreement. However, section 6 of the Trade Marks Act provides that goods and services in respect of which registration of a mark is applied for shall be classified in accordance with the Nice Classification. The following are the class headings under the Nice Classification:

Nice Classification (10th Edition) C L A S S H E A D I N G S

GOODS

- Class 1* Chemicals used in industry, science and photography, as well as in agriculture, horticulture and forestry; unprocessed artificial resins, unprocessed plastics; manures; fire extinguishing compositions; tempering and soldering preparations; chemical substances for preserving foodstuffs; tanning substances; adhesives used in industry
- Class 2* Paints, varnishes, lacquers; preservatives against rust and against deterioration of wood; colorants; mordants; raw natural resins; metals in foil and powder form for painters, decorators, printers and artists
- Class 3* Bleaching preparations and other substances for laundry use; cleaning, polishing, scouring and abrasive preparations; soaps; perfumery, essential oils, cosmetics, hair lotions; dentifrices
- Class 4* Industrial oils and greases; lubricants; dust absorbing, wetting and binding compositions; fuels (including motor spirit) and illuminants; candles and wicks for lighting
- Class 5* Pharmaceutical and veterinary preparations; sanitary preparations for medical purposes; dietetic food and substances adapted for medical or veterinary use, food for babies; dietary supplements for humans and animals; plasters, materials for dressings; material for stopping teeth, dental wax; disinfectants; preparations for destroying vermin; fungicides, herbicides
- Class 6* Common metals and their alloys; metal building materials; transportable buildings of metal; materials of metal for railway tracks; non-electric cables and wires of common metal; ironmongery, small items of metal hardware; pipes and tubes of metal; safes; goods of common metal not included in other classes; ores

-
- Class 7* Machines and machine tools; motors and engines (except for land vehicles); machine coupling and transmission components (except for land vehicles); agricultural implements other than hand-operated; incubators for eggs; automatic vending machines
- Class 8* Hand tools and implements (hand-operated); cutlery; side arms; razors
- Class 9* Scientific, nautical, surveying, photographic, cinematographic, optical, weighing, measuring, signalling, checking (supervision), life-saving and teaching apparatus and instruments; apparatus and instruments for conducting, switching, transforming, accumulating, regulating or controlling electricity; apparatus for recording, transmission or reproduction of sound or images; magnetic data carriers, recording discs; compact discs, DVDs and other digital recording media; mechanisms for coin-operated apparatus; cash registers, calculating machines, data processing equipment, computers; computer software; fire-extinguishing apparatus
- Class 10* Surgical, medical, dental and veterinary apparatus and instruments, artificial limbs, eyes and teeth; orthopedic articles; suture materials
- Class 11* Apparatus for lighting, heating, steam generating, cooking, refrigerating, drying, ventilating, water supply and sanitary purposes
- Class 12* Vehicles; apparatus for locomotion by land, air or water
- Class 13* Firearms; ammunition and projectiles; explosives; fireworks
- Class 14* Precious metals and their alloys and goods in precious metals or coated therewith, not included in other classes; jewellery, precious stones; horological and chronometric instruments
- Class 15* Musical instruments
- Class 16* Paper, cardboard and goods made from these materials, not included in other classes; printed matter; bookbinding material; photographs; stationery; adhesives for stationery or household purposes; artists' materials; paint brushes; typewriters and office requisites (except furniture); instructional and teaching material (except apparatus); plastic materials for packaging (not included in other classes); printers' type; printing blocks
- Class 17* Rubber, gutta-percha, gum, asbestos, mica and goods made from these materials and not included in other classes; plastics in extruded form for use in manufacture; packing, stopping and insulating materials; flexible pipes, not of metal
- Class 18* Leather and imitations of leather, and goods made of these materials and not included in other classes; animal skins, hides; trunks and travelling bags; umbrellas and parasols; walking sticks; whips, harness and saddlery
- Class 19* Building materials (non-metallic); non-metallic rigid pipes for building; asphalt, pitch and bitumen; non-metallic transportable buildings; monuments, not of metal
- Class 20* Furniture, mirrors, picture frames; goods (not included in other classes) of wood, cork, reed, cane, wicker, horn, bone, ivory, whalebone, shell, amber, mother-of pearl, meerschaum and substitutes for all these materials, or of plastics
- Class 21* Household or kitchen utensils and containers; combs and sponges; brushes (except paint brushes); brush-making materials; articles for cleaning purposes; steelwool; unworked or semi-worked glass (except glass used in building); glassware, porcelain and earthenware not included in other classes
- Class 22* Ropes, string, nets, tents, awnings, tarpaulins, sails, sacks and bags (not included in other classes); padding and stuffing materials (except of rubber or plastics); raw fibrous textile materials
- Class 23* Yarns and threads, for textile use

-
- Class 24* Textiles and textile goods, not included in other classes; bed covers; table covers
- Class 25* Clothing, footwear, headgear
- Class 26* Lace and embroidery, ribbons and braid; buttons, hooks and eyes, pins and needles; artificial flowers
- Class 27* Carpets, rugs, mats and matting, linoleum and other materials for covering existing floors; wall hangings (non-textile)
- Class 28* Games and playthings; gymnastic and sporting articles not included in other classes; decorations for Christmas trees
- Class 29* Meat, fish, poultry and game; meat extracts; preserved, frozen, dried and cooked fruits and vegetables; jellies, jams, compotes; eggs; milk and milk products; edible oils and fats
- Class 30* Coffee, tea, cocoa and artificial coffee; rice; tapioca and sago; flour and preparations made from cereals; bread, pastry and confectionery; ices; sugar, honey, treacle; yeast, baking-powder; salt; mustard; vinegar, sauces (condiments); spices; ice
- Class 31* Grains and agricultural, horticultural and forestry products not included in other classes; live animals; fresh fruits and vegetables; seeds; natural plants and flowers; foodstuffs for animals; malt
- Class 32* Beers; mineral and aerated waters and other non-alcoholic beverages; fruit beverages and fruit juices; syrups and other preparations for making beverages
- Class 33* Alcoholic beverages (except beers)
- Class 34* Tobacco; smokers' articles; matches
- SERVICES**
- Class 35* Advertising; business management; business administration; office functions
- Class 36* Insurance; financial affairs; monetary affairs; real estate affairs
- Class 37* Building construction; repair; installation services
- Class 38* Telecommunications
- Class 39* Transport; packaging and storage of goods; travel arrangement
- Class 40* Treatment of materials
- Class 41* Education; providing of training; entertainment; sporting and cultural activities
- Class 42* Scientific and technological services and research and design relating thereto; industrial analysis and research services; design and development of computer hardware and software
- Class 43* Services for providing food and drink; temporary accommodation
- Class 44* Medical services; veterinary services; hygienic and beauty care for human beings or animals; agriculture, horticulture and forestry services
- Class 45* Personal and social services rendered by others to meet the needs of individuals; security services for the protection of property and individuals

END OF DOCUMENT